

**AJP**

# OWNER'S MANUAL



**PR3 125/200/240**

**TRAIL - MX - MX PRO - SUPERMOTO - ENDURO - ENDURO PRO**



**AJP PR3 125 / 200 / 240  
MX / MX PRO / TRAIL / ENDURO /  
ENDURO PRO / SUPERMOTO /  
SUPERMOTO PRO**

# **OWNER'S MANUAL**

This manual should be considered a permanent part of the motorcycle and should remain with the motorcycle when resold or otherwise transferred to a new owner or operator. The manual contains important safety information and instructions that should be read carefully before start operating the motorcycle

**2<sup>nd</sup> Edition - English version  
AJP MOTOS, SA  
JULY 2013**

## **! VERY IMPORTANT !**

**WE STRONGLY RECOMMEND YOU READ THIS MANUAL CAREFULLY AND COMPLETELY BEFORE GOING ON YOUR FIRST RIDE. IT CONTAINS A GREAT DEAL OF INFORMATION AND ADVICE, WHICH WILL HELP YOU USE AND HANDLE YOUR BIKE PROPERLY. IN YOUR OWN INTEREST, PLEASE PAY ATTENTION TO NOTICES THAT ARE MARKED AS FOLLOWS:**

### **! WARNING !**

**IGNORING THESE INSTRUCTIONS CAN ENDANGER YOUR BODY AND YOUR LIFE, AS WELL AS OTHER PEOPLE'S LIVES.**

### **! CAUTION !**

**IGNORING THESE INSTRUCTIONS COULD CAUSE DAMAGE TO PARTS OF YOUR MOTORCYCLE OR THAT THE MOTORCYCLE IS NO LONGER SAFE TO RIDE ANYMORE.**

**TAKE SPECIAL CARE TO FOLLOW THE RECOMMENDED RUN IN, INSPECTION AND MAINTENANCE INTERVALS. FOLLOWING THESE GUIDELINES WILL SIGNIFICANTLY INCREASE THE LIFE OF YOUR MOTORCYCLE. BE SURE TO HAVE ANY MAINTENANCE JOBS PERFORMED BY AN AUTHORIZED AJP DEALER.**

**PLEASE DON'T FORGET TO WEAR A HELMET, EYE PROTECTION AND PROTECTIVE CLOTHING WHEN GOING FOR A RIDE.**

**WE WISH YOU A LOT OF FUN RIDING YOUR AJP!**

AJP MOTOS LDA RESERVES THE RIGHT TO MODIFY ANY EQUIPMENT, TECHNICAL SPECIFICATIONS, COLOURS AND MATERIALS USED WITHOUT PREVIOUS ANNOUNCEMENT AND WITHOUT GIVING REASONS, OR TO CANCEL ANY OF THE ABOVE ITEMS WITHOUT SUBSTITUTING THEM WITH OTHERS. IT SHALL BE ACCEPTABLE TO STOP MANUFACTURING A CERTAIN MODEL WITHOUT PREVIOUS ANNOUNCEMENT. IN THE EVENT OF SUCH MODIFICATIONS, PLEASE CONTACT YOUR LOCAL AJP DEALER FOR INFORMATION. WE SHALL NOT BE HELD LIABLE FOR ANY PRINTING ERRORS.

## TABLE OF CONTENTS

CONSUMER INFORMATION	1
COMPONENTS LOCATION	3
CONTROLS LOCATION	5
CONTROLS	5
KEYS	5
IGNITION SWITCH	5
DIGITAL SPEEDOMETER	6
LEFT HANDLEBAR	6
RIGHT HANDLEBAR	7
FUEL	8
FUEL TANK CAP	8
CHOKE KNOB	8
KICK STARTER LEVER	8
GEARSHIFT LEVER	9
REAR BRAKE PEDAL	9
SIDE STAND	9
SUSPENSION SET-UP	10
BREAK-IN (RUNNING-IN)	11
INSPECTIONS BEFORE RIDING	11
RIDING TIPS	13
ENGINE START	13
STARTING OFF	14
USING THE GEARBOX	14
BRAKING	15
STOPPING AND PARKING	15
INSPECTION AND MAINTENANCE	16
MAINTENANCE SCHEDULE	17
MAINTENANCE WORK	18
LUBRICATION POINTS	18
DRIVE CHAIN	19
BRAKES	20
FRONT WHEEL REMOVAL	24
REAR WHEEL REMOVAL	24
TIRES	25
SPOKE TIGHTNESS	26
BATTERY	26
FUZE	26
LIGHT BULB REPLACEMENT	27
AIR FILTER	27
FUEL FILTER	28
THROTTLE CABLE	28
IDLING	28
ENGINE OIL	28
EXHAUST SYSTEM	29
MOTORCYCLE CLEANING	30
CONSERVATION FOR WINTER OPERATION	30
STORAGE PROCEDURES	30
TECHNICAL SPECIFICATIONS	32

## USER INFORMATION

### ACCESSORY INSTALLATION AND PRECAUTION SAFETY TIPS

There is some variety of accessories for AJP motorcycles. AJP cannot have direct control over the quality or suitability of accessories you may want to purchase. The addition of unsuitable accessories can lead to unsafe operating conditions. Please contact your AJP dealer for assist you in selecting accessories and install them correctly.

#### **! WARNING !**

Improper accessories or modifications can make your motorcycle unsafe and can lead to an accident. Never modify the motorcycle with improper or poorly installed accessories. Follow all instructions in this owner's manual regarding accessories and modifications. Consult your AJP dealer if you have any questions.

Certain accessories displace the rider from his normal position. This limits the freedom of movement and may limit his control ability.

Additional electric accessories may overload the electric system. Severe overloads may damage the wiring harness or create a dangerous situation due to the loss of electric power during the operation of the motorcycle.

When carrying a load on the motorcycle, mount it as low as possible to the machine. An improperly mounted load can create a high center of gravity that is very dangerous and makes the motorcycle difficult to handle. The size of the load can also affect the aerodynamics and handling of the motorcycle. Balance the load between the left and right sides of the motorcycle and fasten it securely.

#### **! WARNING !**

MX and MX PRO versions are not designed or prepared to carry a passenger!

### SAFE RIDING RECOMMENDATIONS FOR MOTORCYCLE RIDERS:

#### **WEAR A HELMET**

Motorcycle safety equipments starts with a quality helmet. One of the most serious injuries that can happen is a head injury. ALWAYS wear a properly approved helmet.

You should also wear suitable eye protection.

#### **RIDING APPAREL**

Loose, fancy clothing can be uncomfortable and unsafe for motorcycle riding. Choose good quality motorcycle riding apparel when riding your motorcycle. Wear gloves, strong boots that fit over the ankle, long pants and long sleeve shirt or jacket.

#### **INSPECTION BEFORE RIDING**

Review all the instructions in the "INSPECTION BEFORE RIDING" section in this manual. Do not forget to perform an entire safety inspection to ensure safety of the rider.

#### **FAMILIARIZE YOURSELF WITH THE MOTORCYCLE**

Your riding skill and your mechanical knowledge form the basis for safe riding. We recommend you to practice riding your motorcycle in an open area without obstacles until you are familiarize with your motorcycle and its controls.

#### **KNOW YOUR LIMITS**

Always ride within the limits of your skills. Knowing your limits and keep within are the foundation to avoid accidents and injuries.

## **BE EXTRA SAFETY CONSCIOUS ON BAD WEATHER DAYS OR BAD ROAD CONDITIONS**

Riding on bad weather days requires extra attention. Braking distances double in a rainy day. If you are not sure about road conditions ride slower and with double care!

### **MODIFICATION**

Modification of the motorcycle or removal of original equipment may render the vehicle unsafe or illegal.

### **ROAD USE**

MX and MX PRO versions are not allowed for road riding. These versions doesn't have the required equipment for road riding, such as front lights, blinkers, taillights, horn, speedometer, etc. You can only ride with MX and MX PRO versions on a private track.

## **! WARNING !**

MX and MX PRO versions are not equipped for road riding!  
These versions can only circulate on a private track!

### **SERIAL NUMBER LOCATION**

The frame and/or engine serial number are used to register the motorcycle. They are also used to assist your dealer when ordering parts or referring to special service information.

### **Chassis number**

The chassis number is stamped on the right side of the steering head tube.

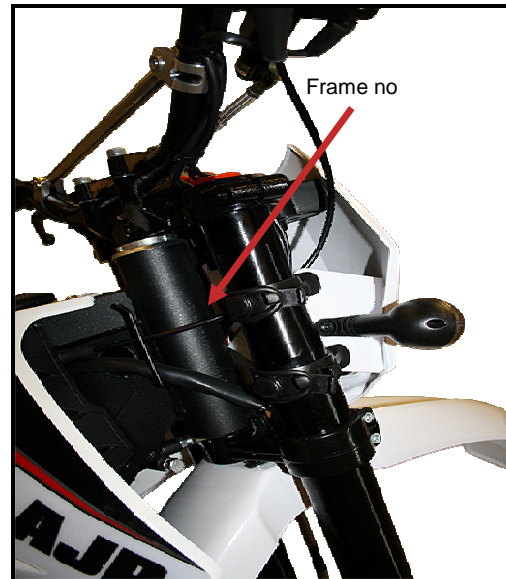

### **Engine number**

The engine number is stamped into the left side of the engine below the engine sprocket, between gearshift lever and the oil cap.

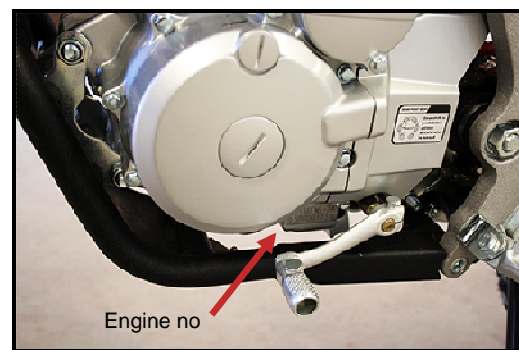

# COMPONENTS LOCATION

MX, MX PRO

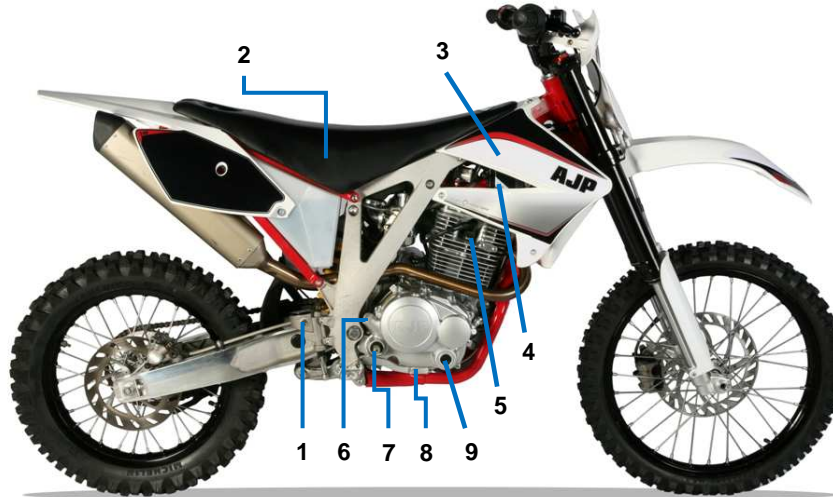

TRAIL, ENDURO, ENDURO PRO, SUPERMOTO, SUPERMOTO PRO

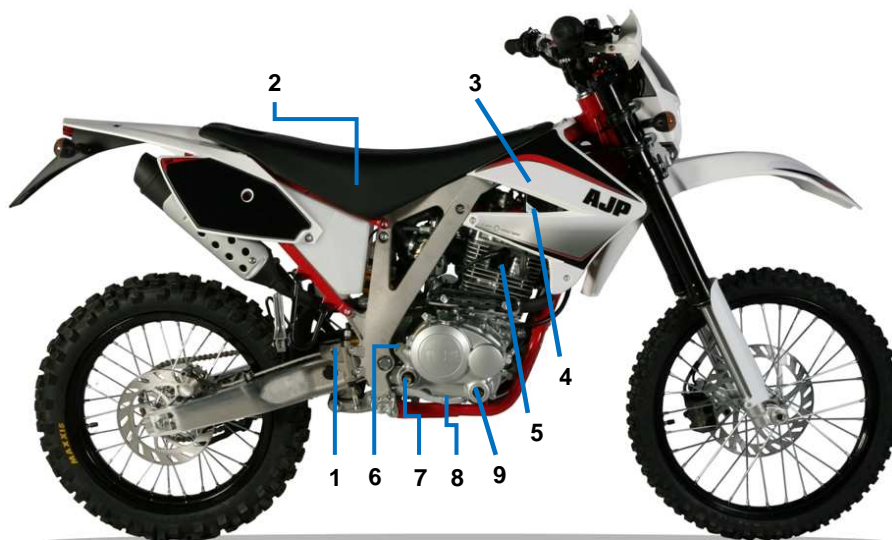

- 1 Rear brake fluid reservoir
- 2 Air filter
- 3 Fuse
- 4 Battery
- 5 Spark plug
- 6 Oil dipstick
- 7 Kick-starter
- 8 Rear brake pedal
- 9 Oil level glass

MX, MX PRO



TRAIL. ENDURO. ENDURO PRO. SUPERMOTO. SUPERMOTO PRO

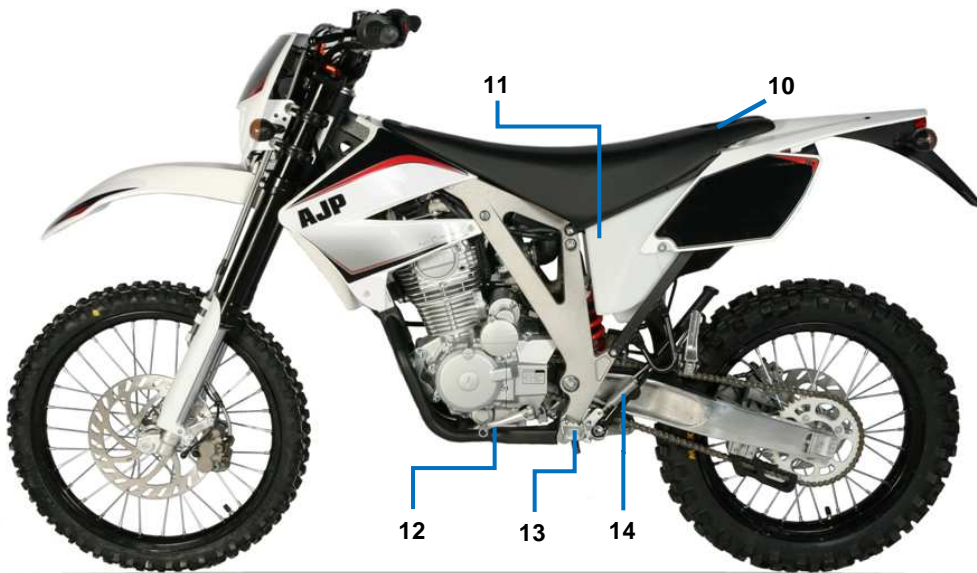

- 10 Fuel tank cap
- 11 Fuel tank
- 12 Gearshift lever
- 13 Foot-rest
- 14 Side rest



## CONTROLS LOCATION

### MX, MX PRO

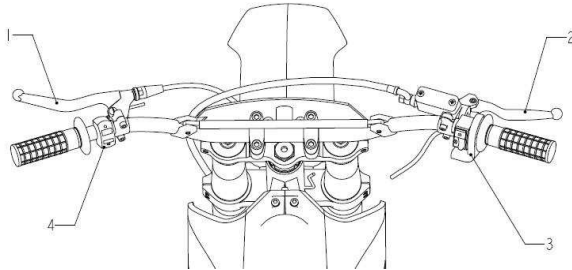

1	Clutch
2	Front brake lever
3	Starter button and On-Off switch
4	On-Off switch

### TRAIL, ENDURO, ENDURO PRO, SUPERMOTO, SUPERMOTO PRO

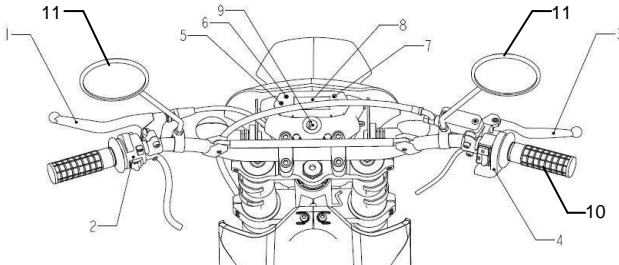

1	Clutch lever
2	Blinker, lights, horn switch
3	Front brake lever
4	Starter button and On-Off switch
5	Neutral sign
6	Headlight sign
7	Turn light sign
8	Digital speedometer
9	Ignition switch
10	Throttle grip
11	Rear view mirrors

## CONTROLS

### KEYS

This motorcycle comes with a pair of keys. Be aware to keep one of the keys in a safe place, at home for instance, in order to let you access this key in case of need.

### IGNITION SWITCH

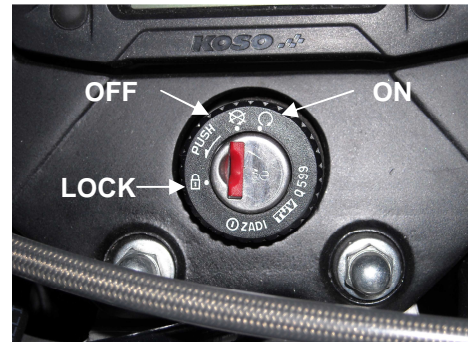

**LOCK** position – all electrical circuits are cut off and the engine will not start. The steering lock is actuated and the handlebar cannot turn. The key can be removed. To pass to lock position, the switch must be in OFF position and the pushed down and turned to the left. The handlebar must be turned all the way to the left.

**OFF** position - all electrical circuits are cut off and the engine will not start. The key can be removed.

**ON** position – the ignition circuit is on and the engine can now be started. The key cannot be removed from the ignition switch.

### **! CAUTION !**

To activate **LOCK** position, the switch must be in **OFF** position, then pushed down and turned to the left. Handlebar should be turned all the way to the left. If not, the switch will not pass to **LOCK** position.

## ! CAUTION !

Don't try to ride with the switch on LOCK position. The steering is locked and control of the motorcycle is impossible.

Don't turn the ignition key to LOCK position while driving!

Note: Start engine as soon as you turn key to ON position. Otherwise battery will lose power due to the consumption of the digital speedometer and headlight and taillight, if turned on.

## DIGITAL SPEEDOMETER



The digital speedometer is not available for the MX and MX PRO versions. It gives information about instantaneous speed and total or trip distance travelled. Depending on the selling market, speed and distance are indicated in Kilometres or miles. If you want to switch between these units, please contact your AJP dealer. To switch from total to trip distance push button 1. To reset trip distance the trip distance must be selected; then push button 1 until the distance is reset to zero.

## LEFT HANDLEBAR

MX, MX PRO

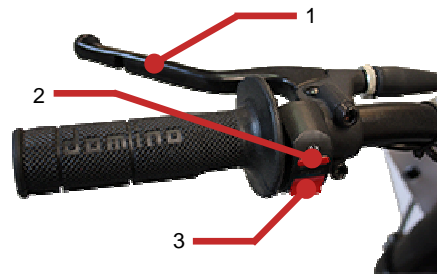

### 1 – Clutch lever

The clutch lever is used for disengaging the drive to the rear wheel when starting the engine or shifting the transmission gear. Squeezing the lever disengages the clutch.

### 2 – Engine kill

To kill engine running, actuate this button.

### 3 – Engine run

To allow engine running, this button must be actuated.

## ! CAUTION !

If ENGINE RUN button is not actuated, engine will not start! You can unload battery charge if you try to start with ENGINE RUN button not actuated!

TRAIL, ENDURO, ENDURO PRO, SUPERMOTO, SUPERMOTO PRO

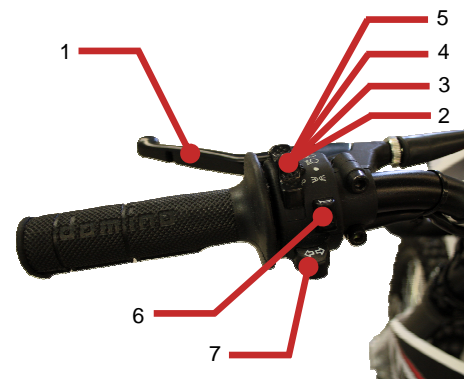

### 1 – Clutch lever

The same as MX and MX PRO.

### 2 – Parking light on

With the light knob in this position, parking lights in the headlight and taillight will be switched on.

### 3 – Lights off

In this position, no lights will be switched on.

### 4 – Low beam on

In this position, low beam light will be on in the headlight and presence light will be on in the taillight.

### 5 – High beam on

In this position, high beam light will be on in the headlight and presence light will be on in the taillight.

### 6 – Turn sign on

Turning this button left left turn lights will be on. Turning right, right turn lights will be on. To switch turn lights off, place the button in middle position.

### 7 – Horn

To actuate horn, press this button.

## ! CAUTION !

In several countries, motorcycle riding is only allowed with low beam on! Respect your national legislation!

## ! CAUTION !

Turn lights are not switched off automatically! Be aware to switch turn lights off after turning or overtaking! Otherwise you will give wrong information about your riding to other drivers!

## RIGHT HANDLEBAR

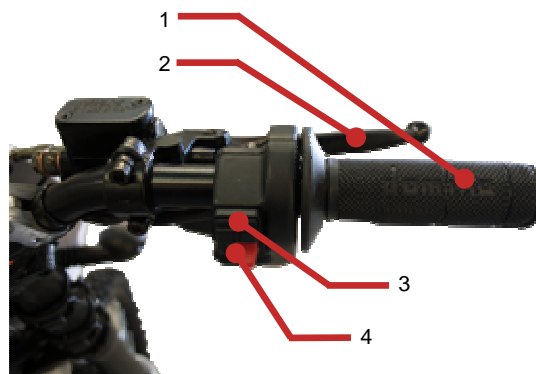

### 1 – Throttle grip

Engine speed is controlled by the position of the throttle grip. Rotate it toward you to increase engine speed; turn it away to decrease engine speed.

### 2 – Front brake lever

Front brake is applied by squeezing brake lever gently toward the throttle grip.

### 3 – Electric start button

This button is used for turning the starter motor. With the ignition switch in the ON position, the transmission in neutral, starter switch on, pull the clutch lever and push the electric start button to engage the starter motor and start the engine.

### 4 – Emergency switch

This switch has two positions: to the left enables engine running, to the right stops engine running. Be aware that this switch is switched ON for engine starting.

## ! CAUTION !

If EMERGENCY SWITCH is not ON, engine will not start! Start motor will not be actuated!

## ! CAUTION !

The EMERGENCY SWITCH should be used to stop the engine in emergency situations! Do not use it to stop the engine when driving otherwise the ignition system will be destroyed!

## FUEL

AJP PR3 engines need unleaded premium gasoline with an octane number of 95 or higher. Never use leaded fuel to avoid destroying catalytic converter and the exhaust system.

### **! WARNING !**

Using not recommend fuel can cause severe damages on engine! Be sure to use only unleaded gasoline with an octane index equal or higher than 95!

## FUEL TANK CAP

Turn the fuel tank cap (1) counter-clockwise to open it. Turn clockwise to close and tighten it securely.



### **! WARNING !**

Gasoline is highly flammable and poisonous. Extreme caution should be used when handling gasoline.

- Do not refuel motorcycle near open flames or burning cigarettes.
- Always switch off engine before refuelling
- Be careful not to spill gasoline on the engine or exhaust pipe while the engine is hot
- Wipe up spills promptly.
- If gasoline is swallowed or splashed in the eyes, seek a doctor's advice immediately.
- Keep children and pets away.

### **! CAUTION !**

Because of the transparent fuel tank, there is not fuel indicator or light warning! Control fuel level when you start the motorcycle and when you are riding for some time!

## CHOKE KNOB

The AJP PR3 carburettor is equipped with a choke system to provide easy starting when the engine is cold. When the engine is cold, pull the lever up; it has two positions: the first (1) is for when engine temperature is more than 20°; the second (2) is for when engine temperature is below 20°. Choke works best when throttle is on closed position. When the engine is warm - above 40°- you do not need to use choke for starting (0).

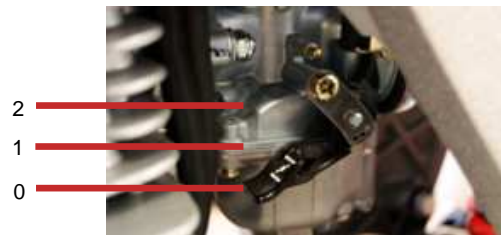

## KICK STARTER LEVER

AJP PR3 are equipped with a kick-start lever, just in case electric start fails.

The kick-starter lever is mounted on the right side of the engine and its upper part can be swivelled. To be actuated it should be rotated outside.

### **! WARNING !**

If you want to start engine, make sure you always wear rigid footwear, like motorcycle boots, in order to avoid injuries. You might slip of the kick-starter or engine may kick back and hit your leg very strongly! Always kick kick-starter briskly all the way without opening the throttle; if you don't do it with enough momentum and with throttle open, kick back hazard will increase!

## **! WARNING !**

Be sure kick-starter lever is returned to its home position after starting the engine.

An improperly retracted kick-starter lever can interfere with rider control!

## **GEARSHIFT LEVER**

AJP PR3 has a 5-speed transmission. Shift lever is mounted on the left side of the engine. The position of the gears is shown in the illustration. Neutral is located between first and second gear.

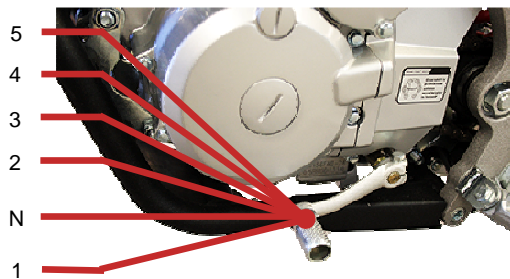

To shift properly, pull the clutch lever and close the throttle at the same time you operate gearshift lever. Lift the lever to up-shift and depress to downshift.

## **REAR BRAKE PEDAL**

The foot brake pedal is disposed in front of the right footrest. Depressing the rear brake pedal will apply the rear brake.

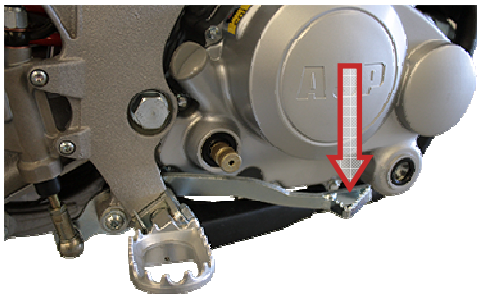

## **! WARNING !**

If position of hand brake lever or rear brake pedal feels “spongy” (too much smooth), this is an indication that the brake system is not functioning well. Don’t ride anymore your motorcycle without first having the brake system checked by an AJP dealer!

## **SIDE STAND**

Push the side stand to the ground with your foot and load it with the motorcycle. Make sure that you put the motorcycle on solid ground and in a secure position.

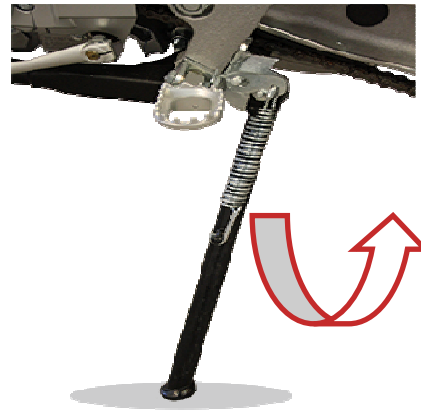

## **! WARNING !**

Always check if you have folded back the side stand before each ride. If the side stand touches the ground while you drive, you may lose control of your motorcycle!

## **! CAUTION !**

The side stand was designed only for the weight of the motorcycle. If you get on the motorcycle and thus put additional weight, the side stand or frame can be damaged and the motorcycle may fall on the side!

## **! CAUTION !**

Park the motorcycle on solid level ground to help prevent it from falling over.

If you must park on an incline, aim the front of the motorcycle uphill and put the transmission into 1<sup>st</sup> gear to reduce the chance of rolling off the side stand.

## **SUSPENSION SET-UP**

### **Front suspension adjustment**

AJP PR3 are equipped with an up-side down fully adjustable front fork.

To adjust compression, turn the upper screw (1) clockwise to have a harder response. Turn counter clockwise to have a softer response.

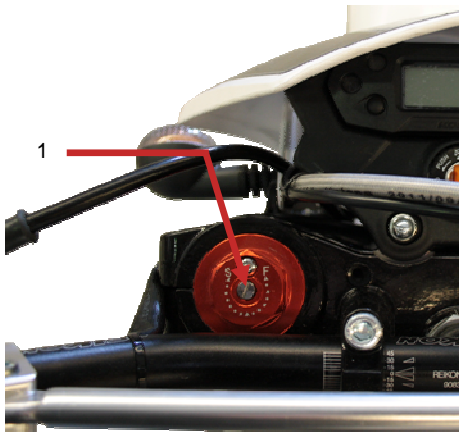

### **Standard compression: 2 clicks**

To adjust rebound, remove the protective plug at the tube lower end, turn the lower screw (2) clockwise for more rebound; turn counter clockwise for less rebound.

### **Standard rebound: 5 clicks**

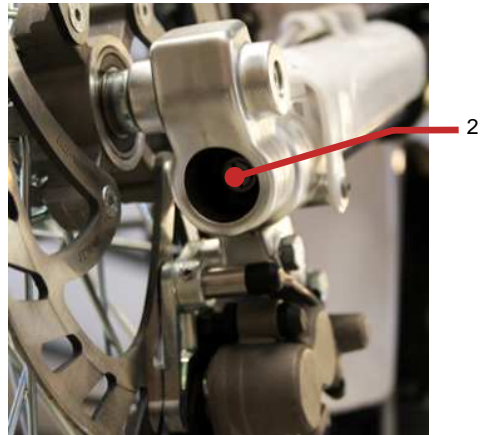

## **! WARNING !**

Unequal suspension adjustment can cause poor handling and loss of stability.

Adjust the right and left front legs to the same settings.

### **Rear suspension adjustment**

MX, Trail, Enduro and Supermoto – These versions are equipped with a shock absorber that allows only pre-charge setting.

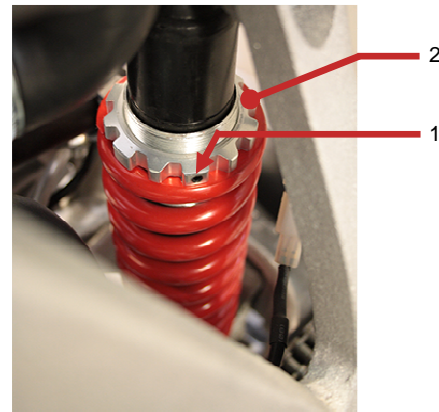

To adjust pre-charge, loose first the fixation screw (1). Turn adjusting nut (2) clockwise for more pre-charge or counter clockwise for less pre-charge.

MX PRO, Enduro PRO and Supermoto PRO – These versions are equipped with a fully adjustable shock absorber.

To adjust pre-charge loose first the upper nut (1), then turn adjusting nut (2)

clockwise for more pre-charge or counter clockwise for less pre-charge.

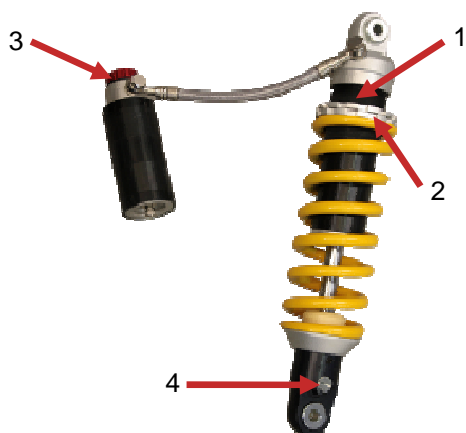

### Compression:

To adjust damping force, turn the button placed on the top of the gas reservoir (3) clockwise for more damping force or counter clockwise for less damping force.

### Rebound:

To adjust rebound, turn the screw (4) clockwise for more rebound speed. To reduce rebound speed turn counter clockwise.

### Standard Sachs Shock absorber (PRO Versions) settings:

Spring length:

- Enduro 205mm;
- Supermoto 210mm.

Damping force: turn all to close position (+) and then turn 20 clicks to open (-).

Rebound: turn all to close position (H) and then turn 11 clicks to open (S).

### ! WARNING !

Improper servicing of the rear shock absorber assembly is dangerous. The rear shock absorber contains high-pressured gas and can explode if improperly serviced.

## BREAK-IN (RUNNING-IN)

The following explains why is so important proper break-in to achieve maximum life and performance from your new AJP.

Even very precisely machined sections of engine components have rougher surfaces than components that have been sliding across one another for quite some time; therefore, every engine needs to be broken in during the first 1.000 Km.

For this reason, do not load engine more than 50% of its capacity during the first 500 kilometres, avoiding full-throttle. In the following 500 kilometres, you may load the engine up to 75% of its capacity, using the gearbox frequently.

Allow sufficient idling time, about 1-2 minutes, after warm or cold engine start up before applying load or revving the engine. This allows time for the lubricating oil to reach all critical engine components.

Note: Be aware of your first and most critical service. The 1.000 Km service is the most important service your AJP will receive. All adjustments will be restored, all fasteners and spokes will be tightened, engine oil will be replaced and oil filter cleaned.

### ! WARNING !

Incorrect break-in may cause severe damage to your motorcycle or significantly reduce your motorcycle lifetime!

## INSPECTIONS BEFORE RIDING

**Check the following before each start**

When you start off, the motorcycle must be in perfect mechanical condition. For safety reasons, you should make a

habit of performing an overall check before each start.

The following checks should be performed:

1 – **Oil level.** Insufficient oil quantity results in premature wear in engine components and damages in engine itself.

2 - **Fuel.** Check there is sufficient fuel in the tank;

3 - **Drive chain.** A loose chain can fall from the chain wheels; an extremely worn chain can tear and insufficient lubrication can result in excessive wear to the chain and chain wheels. Excessive tensioning of the chain will put additional load on the components of the secondary drive train (chain, bearings of transmission and rear wheel). Aside from resulting premature wear, the chain may even rupture or the transmission axle may break.

4 - **Tires.** Check for cuts or dents and replace tires if necessary. The tread must also comply with legal regulations. Check air pressure; insufficient tread and incorrect air pressure deteriorate driving performance.

5 - **Brakes.** Check correct functioning of the braking system and brake fluid level in both reservoirs. The reservoirs have been designed in such a way that brake fluid does not need to be refilled even when brake pads are worn. If the level of brake fluid falls below the minimum value, this indicates a possible leak or completely worn pads. Manage for the brake system to be checked by an AJP dealer, as complete failure of the system can be avoided.

Also check status of the brake hoses and the thickness of brake linings, as well as free travel of hand brake lever and foot brake pedal.

6 - **Electric system.** Check correct functioning of headlamps, taillights, brake lights, indicators, control lamps and horn while the engine is running.

7 - **Luggage.** If you are taking any luggage with you, check that it is securely fastened.

8 – **Steering** – Check for smoothness, no restriction on movement and no play or looseness.

9 – **Throttle** – Check for correct play, smooth operation and positive return to the closed position.

10 – **Clutch** – Check for correct play, smoothness and progressive action.

11 – **Suspensions** – Check suspensions for smooth movement.

12 – **Engine stop switch** – Check for correct function.

### **! WARNING !**

Failure to run these inspections and maintain your motorcycle properly increases the chance of an accident or equipment damage

Always perform a pre-ride inspection before each ride. Refer to the list behind for check items. For further details, refer to the INSPECTION AND MAINTENANCE section.

### **! WARNING !**

Using worn, improperly inflated or non-homologated tires will reduce stability and can cause an accident. Follow all instructions in the TIRES section.

### **! WARNING !**

Checking maintenance items when the engine is running can be hazardous. You could be severely injured if your hands or clothing get caught in moving parts!



## RIDING TIPS

### **! WARNING !**

- Wear suitable clothing when driving a motorcycle. Never forget to wear a helmet, gloves and boots, even in short trips. Protective clothing should be brightly coloured to make you more visible to other drivers.
- Always turn on the lights to make sure that other drivers become aware of you as early as possible.
- Do not drive after having consumed alcohol or drugs.
- Use only original spare parts and accessories.
- Front and rear tires are allowed to be fitted only with tires having the same original profile type.

### Instructions for initial operation

- Verify if your AJP dealer performed a previous preparation of the motorcycle.
- Read this manual carefully before you ride.
- Familiarize yourself with all the operating controls.
- Get used to the handling of the motorcycle on an empty parking lot or open space, before going for a longer ride. Try also to drive as slow as possible and in sitting position to improve your feeling of the motorcycle.
- Hold the handlebar with both hands and leave your feet on the footrests while driving.
- Remove your foot from the brake pedal when you are not braking. If the brake pedal is not released the brake pads will rub continuously and the braking system will overheat.
- Do not make any changes to the motorcycle and use always AJP original spare parts for safety reasons.
- Motorcycles are sensitive to changes in the weight distribution. If you are taking any luggage with you, secure it as close as possible to the middle of the motorcycle, in order to distribute the weight for both wheels.

## ENGINE START

### Starting when the engine is cold

- 1- Swing up the side stand and turn the ignition key on.
- 2- Put the gear in neutral (the neutral pilot lamp will light up).
- 3- Operate the choke lever all the way up.
- 4- Check if the emergency switch is on running position.
- 5- Operate the electric start button or kick the kick-starter briskly all the way without touching the throttle.

### **! CAUTION !**

Never actuate electric starter for more than 5 seconds and with lights on. Wait at least 5 seconds before trying again.

### **! WARNING !**

Before you start off, check the side stand has been fully swung up. If the side stand drags on the ground, the motorcycle goes out of control. Always turn on the light to make sure that other drivers become aware of you as early as possible.

### **! WARNING !**

Never ride your motorcycle with full load or rev the engine when cold. Because the piston is warming up faster than the cylinder, it can cause engine damage.

### Starting when the engine is warm

- 1- Swing up the side stand and turn the ignition key on
- 2- Put the gear in neutral
- 3- Check if the emergency switch is on running position.
- 4- Operate the electric start button or kick the kick-starter briskly all the way without touching the throttle.

## What to do when the engine is “flooded”

In the event of a fall, more fuel than necessary may get into the engine. In order to “pump the engine free”, fully rev up the engine, actuate the kick-starter 5 to 10 times or actuate the electric starter twice for 5 seconds each. Then, start the engine as described above.

If the engine fails to start, unscrew the spark plug and dry it.

NOTE: PR3 carburettor is equipped with an acceleration pump (Power Jet). Each time you open the throttle, extra fuel is pumped to engine inlet. Therefore, when starting, you should take care to open the throttle progressively (or full) in one time.

### **! WARNING !**

- If you want to start the engine with kick start pedal, make sure you always put on rigid motorcycle boots in order to avoid injuries. You might slip off the kick-starter or the engine may kick back and hit your foot upward very strongly.
- Always kick kick-starter briskly all the way without opening the throttle; if you don't do it with enough momentum and with the throttle open, kick back hazard will increase.
- Do not start the engine or allow it to idle in a closed area. Exhaust gases are poisonous and can cause loss of consciousness and even death. Always provide adequate ventilation while the engine is running.
- Never leave engine running for a more than 5 minutes while the motorcycle is parked: engine will overheat and severe damage may occur.

## STARTING OFF

Pull the clutch lever and put the engine into first gear. Slowly release the clutch

lever and open the throttle at the same time.

## USING THE GEARBOX

The first gear is referred as the drive or uphill gear. Depending on the conditions (traffic, hill size, etc.), you can shift to a higher gear. Close throttle, at the same time you pull clutch lever and shift to the next higher gear. Let clutch go again and give gas. If you turned on the choke lever, make sure you turn it off again as soon as engine is warm.

When you reach full speed by opening the throttle all the way, turn throttle back to  $\frac{3}{4}$ ; the speed hardly decreases and the engine will use less fuel.

Only give as much gas as the engine can handle. Through quick and high revving of throttle, the fuel consumption increases.

By shifting down, use the brakes if necessary and close throttle at the same time. Pull clutch lever and shift down to the next gear. Let clutch lever go slowly and open throttle or shift down again.

### **! CAUTION !**

- High RPM speed when engine is cold have an adverse effect on the life of your engine. We recommend you to run the engine in a moderate RPM range for 5/10 Kilometers/miles giving it the chance to warm up.
- Never have the throttle wide open when shifting down a gear. The engine will over-rev, damaging the valves.
- If any abnormal vibrations occur while driving, check that the engine fastening bolts are tight. If it remains contact an authorized AJP dealer.
- If you notice any unusual operation-related noise while riding, stop immediately, shut the engine off and contact an authorized AJP dealer.

- Never start your motorcycle without air filter in place, otherwise dust and dirt may enter to the engine and cause increased wear or damage.

## **BRAKING**

Apply both brakes at the same time with the throttle closed. When driving on sandy, wet or slippery ground use mainly the rear brake. Avoid blocking the wheels, otherwise you may skid or fall; also you can change down to a lower gear depending on your speed.

### **! WARNING !**

Inexperienced riders tend to under use front brake. This can cause excessive stopping distance and lead to a collision. Using only front or rear brake can cause skidding and loss of control.

Apply both brakes evenly and at the same time.

Use the braking effect of the engine when driving downhill to assist the brakes; change down one or two gears but do not over-speed the engine. This way, you will not need to use the brakes so much and avoid overheating.

### **! WARNING !**

Hard braking while turning may cause wheel skid and loss of control.

Brake before you begin to turn.

### **! WARNING !**

Hard braking on wet, loose, rough or other slippery surfaces can cause wheel skid and loss of control.

Brake lightly and with care on slippery or irregular surfaces.

## **STOPPING AND PARKING**

Apply the brakes fully and put the engine into neutral. To turn off the engine, apply the emergency off button

or turn the key to OFF position on the ignition switch with the engine at idling speed until the engine stops. Park on an area where the ground is firm and lock the motorcycle.

### **! WARNING !**

- Never leave your motorcycle without supervision if the engine is running or with children nearby.

- Motorcycle engines produce a great amount of heat when running. Engine, exhaust pipe, muffler, brake callipers and shock absorber can become very hot. Do not touch any of these parts after operating the motorcycle or allow children to come nearby.

- Take care to park the motorcycle where pedestrians are not likely to touch it and get burned.

- Never park your motorcycle in places where there is fire hazards, such as dry grass or other easily flammable materials.

FOR MX and MX PRO

Actuate the engine kill button to shut off the engine.

### **! WARNING !**

- Observe traffic regulations and drive defensively, trying to look ahead as far as possible so that any hazards can be recognized as early as possible.

- Adjust your driving speed according to the conditions and your driving skills.

- Drive carefully in unknown roads or unfamiliar trials.

- When driving off-road, always have a friend on a second motorcycle to make you company, so you can help each other if some problem happens.

- Replace helmet visor or goggle lens when scratched or damaged. If

bright light shines through a scratched, the driver will be blinded.

- In case of a fall, check all functions thoroughly before start operating the motorcycle.

- Do not repair twisted handlebar: Replace it immediately.

**Note regarding side stand:**

Push the side stand to the ground with your foot and load it with the motorcycle. Make sure that you put the motorcycle on solid ground and in a secure position. Just in case, you can shift into first gear.

**! CAUTION !**

Side stand was designed only for the weight of the motorcycle. If you get on the motorcycle and thus put additional weight, side stand or frame can be damaged and the motorcycle may fall on the side.

**INSPECTION AND MAINTENANCE**

The list indicates intervals between periodic services in Kilometres. At the end of each interval, be sure to inspect, check, lubricate and service as instructed. If your motorcycle is used under high stress conditions such as continuous full throttle operation or is operated in a dusty climate, certain services should be performed more often to insure reliability of motorcycle as explained in maintenance section.

Your AJP dealer can provide you with further guidelines.

Steering components, suspension and wheel components are key items and require very special and careful servicing. For maximum safety we suggest that you have these items inspected and serviced by your authorized AJP dealer.

**! WARNING !**

Do not start the engine or allow it to idle in a closed area. Exhaust gases are poisonous and can cause loss of consciousness and even death.

Always provide adequate ventilation while the engine is running.

**! WARNING !**

It is owner's responsibility to assure that motorcycle is serviced within this periodic maintenance schedule.

AJP does not assume any damage if maintenance is not performed as schedule.

**! WARNING !**

Improper maintenance or failure performs of recommended maintenance increases the chance of accident or motorcycle damage.

Always follow inspection and maintenance recommendations and schedules in this owner's manual. Ask your AJP dealer to do the maintenance items marked with an asterisk (\*). You may perform the unmarked maintenance items by referring to instructions in this section, if you have mechanical experience. If you are not sure how to do any of the jobs, have your AJP dealer to do them.

**! WARNING !**

An intense riding, with high revolutions, tracks with dust and mud, demands cleaning and maintenance more frequent than recommended, to assure correct motorcycle functioning.

## **! CAUTION !**

Using poor quality replacement parts or materials can cause your motorcycle to wear more quickly and may shorten its useful life. Use only genuine AJP replacement parts.

### **MAINTENANCE SCHEDULE**

A description of several necessary operations to a correct functioning of motorcycle and periods is as follows.

#### **DAILY**

Check engine oil level and refill if necessary.  
Check clearance of secondary chain.  
Check brake system functioning.

#### **AFTER FIRST 1.000 km – BREAK IN**

Replace spark plug;  
Replace engine oil;  
Clean engine oil filter;  
Check engine oil level;  
Check air filter. Clean and wet in oil;  
Check valve clearance;  
Check correct functioning of: braking system, spoke tightness; tire condition; clutch cable; side stand; steering stem bearings; suspensions; battery; exhaust; electrical system.  
Check secondary chain;  
Check wheel gear bolts tightening;  
Check tightness of several components bolts and clamps.

#### **EACH 500 km OR MONTH**

Check oil level and refill if necessary.  
Check air filter. Clean and wet in oil;  
Check, adjust, clean and lubricate drive chain;  
Check wheel gear bolts tightening;

#### **EACH 3.000 km OR 6 MONTHS**

Replace spark plug;  
Replace engine oil and clean engine oil filter;  
Check engine oil level;  
Check valve clearance;  
Check timing chain clearance;  
Check timing tensioner;  
Check ignition system functioning;  
Clean carburetor;  
Check air filter. Clean and wet in oil;  
Replace fuel filter;  
Check fuel feed, lubrication and oil cooler tubes;  
Check tubes and oil radiator (200 and 240cc engines)  
Adjust and lubricate throttle cable;  
Adjust and lubricate clutch cable;  
Check condition and functioning of several component of electrical system;  
Check battery. Control voltage with or without charge;  
Check braking system functioning and stop switches;  
Check brake pads,  
Check brake fluid level;  
Check, adjust, clean and lubricate secondary chain;  
Check wheel gear bolts tightening;  
Check wheels bearings;  
Check tires condition;  
Check spoke tightness;  
Check side stand functioning;  
Check steering functioning;  
Check suspensions functioning;  
Check exhaust: condition, leaks and noise level;  
Check tightness of bolts, nuts, clamps of diverse components.

#### **EACH 6.000 km OR 12 MONTHS**

Perform operations indicated for each 3.000 km, plus:  
Replace spark plug;  
Clean carburetor and check the right settings;  
Clean air filter box and replace sealing silicon at the cover;

Clean and lubricate or replace air filter;  
 Check intake manifold (between air filter box and carburetor);  
 Replace fuel filter;  
 Check fuel feed hoses;  
 Check functioning of fuel cap valve;  
 Lubricate steering stem bearings;  
 Lubricate rear suspension links;  
 Lubricate swing arm bearings.  
 Check wheels bearings;  
 Check/replace front fork sealings.

**EACH 12.000 km OR 24 MONTHS**  
 Perform operations indicated for each 3.000 and 6.000 kms, plus:  
 Clean fuel tank;  
 Replace drive chain;  
 Replace brake fluids;  
 Replace front fork oil and/or fork seals;

**MAINTENANCE WORK**

**! WARNING !**  
 Improper maintenance or failure performs of recommended maintenance increases the chance of accident or motorcycle damage. Always follow inspection and maintenance recommendations and schedules in this owner's manual. Ask your AJP dealer to do the maintenance items marked with an asterisk (\*). You may perform the unmarked maintenance items by referring to instructions in this section, if you have mechanical experience. If you are not sure how to do any of the jobs, have your AJP dealer to do them.

**LUBRICATION POINTS**

Proper lubrication is important for smooth operation and long life of each working part of your motorcycle and also for safe riding. It is a good practice to lubricate the motorcycle after a long rough ride and after getting in snow,

wet, mud or after washing it. Major lubrication points are indicated.

**! CAUTION !**

- When cleaning your motorcycle, do not use a high-pressure cleaning unit, otherwise water will penetrate bearings, carburettor, electric connectors, etc.
- When transporting your AJP, ensure that it is held upright with restraining straps.
- Use only special screws with an appropriate thread length supplied by AJP to fix fuel tank. Using other screws or longer ones can cause cracks in the tank through which fuel can flow out.
- Let your motorcycle cool down before beginning any maintenance work in order to avoid get burned.
- Remove oil, grease matters, filters, fuel, washing detergents, etc, orderly.
- Under no circumstances may used oil be disposed off in the sewage system or in the open countryside. Remember: 1 litre of used oil contaminates 1.000.000 litres of water!

Checking and adjusting the steering head bearings (\*)

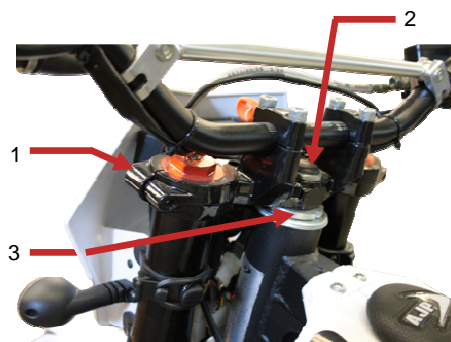

Check steering head bearings for play periodically. For check, place motorcycle on a stand so that the front wheel is off the ground. Try to move the fork forward and backward. For readjusting, loosen top nut (2) and the

two bolts (1) of the top triple clamp and turn steering stem bolt (3) clockwise until there is no more play. Don't tighten the steering stem bolt (3) all the way; otherwise the bearings will be damaged. With a plastic hammer, lightly rap on the triple clamp to release tension and retighten the bolts. Then tight top nut (2) and the top triple clamp screws (1). Steering head bearings should be greased at least once a year.

### **! WARNING !**

If steering head bearings are not adjusted to be free of play or too tight, the motorcycle will become unstable and can get out of control. Also they might be permanently damaged.

### **! CAUTION !**

If you drive with play in the steering head bearings for long periods, bearings and subsequently bearing seats in the frame will be destroyed.

### **Cleaning the dust sleeves of the telescopic fork**



The dust protection gaskets (1) are to remove dust and coarse dirt particles from the fork tube. However, after some time, dirt may also get behind the dust protection gasket. If this dirt is not removed, the oil sealing rings located behind it may start to leak.

Use a screwdriver to lever the dust-protection bellows out of the outer tubes and slide them downward.

Clean dust-protection gaskets, outer tubes and fork tubes thoroughly, and oil them with silicone spray or engine oil;

then push dust-protection gaskets into the outer tubes by hand.

## **DRIVE CHAIN**

### **Drive chain adjustment**

The chain slack must be of 15-30mm, at the mid point between the chain buffer and the rear sprocket.

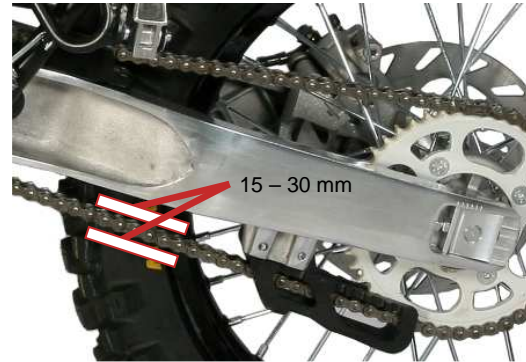

To adjust the drive chain, follow the procedure bellow:

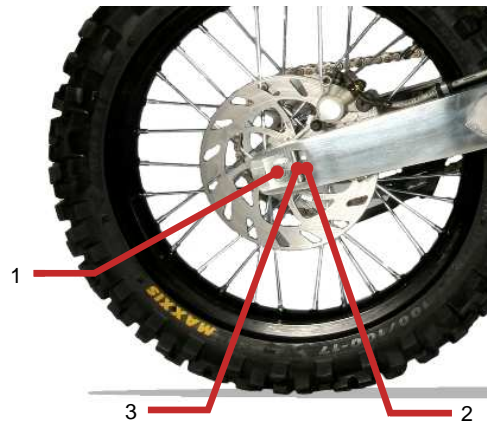

1 - Place the motorcycle on the side stand

2 - Loose axle nut (1)

3 – Loose fixing nuts on both sides (2)

4 – Regulate adjuster screws (3) until the chain has 15-30mm of slack. At the same time that the chain is being adjusted, the rear sprocket must be kept in perfect alignment with the front sprocket. Align both right and left adjusters to the same position.

4 - Re-tighten the axle nut securely and tighten fixing nuts (2).

5- Recheck the chain slack after tightening, lubricate and adjust if necessary.

### **! WARNING !**

- Excessive tensioning of the chain will put additional load on the components of the secondary drive chain (chain, bearings and rear wheel). Aside from resulting premature wear, chain may rupture or transmission countershaft may break.
- On the other hand, too much slack in the chain can result in chain jumping off the chain wheels. If this happens, chain could also block rear wheel or damage the engine.
- In either case, operator is likely to lose control of the motorcycle.

### **Drive chain maintenance**

A good maintenance is very important for long chain life. Chains without o-rings should be cleaned in fireproof solvent regularly and afterwards treated with hot grease or chain spray. On the other hand, o-ring chains are very simple to clean. The best way is to use lots of water but never use brushes or cleaning liquids. After letting the chain dry completely, use a chain spray to lubricate it.

Also check sprockets and chain guides for wear and replace if necessary.

### **! WARNING !**

No lubrication should be allowed to reach rear tyre or rear brake disc, otherwise road adherence and rear wheel braking effects will be strongly reduced and the motorcycle can easily get out of control.

### **! CAUTION !**

When mounting chain master link clip, the closed side of the master link must point in the running direction.

## **BRAKES**

### **Brake pads**

Front brake pads are fitted with SF-F026A. Rear brake pads are fitted with 11705. These linings provide an optimal combination of braking power, brake performance and lifecycle.

### **Brake discs (\*)**

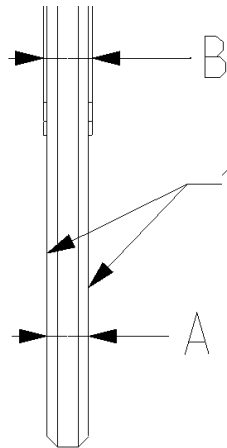

Due to wear, the thickness of brake discs in the area of the contact face (1) of the brake pads decreases. At their thinnest point (A), the brake discs must not be more than 0.50mm thinner than the pads nominal thickness. Measure the nominal thickness in a location (B) outside the contact face and check for wear in several locations.

### **! WARNING !**

- For your own safety, have the brake discs replaced immediately as soon as they reach wear limit (3 mm thickness).
- Have any repairs on brake system performed by an AJP authorized dealer.



## Brake fluid reservoirs

Brake fluid reservoirs have been designed in such a way that even if the brake pads are worn it is not necessary to refill brake fluid. If brake fluid level drops below the minimum level, either the brake system has a leak or the brake pads are completely worn. In this case, consult an authorized AJP dealer immediately.

## Brake fluid

AJP fills the brake systems with DOT 4 brake fluid; we recommend that you continue to use it.

### Recommended brake fluid:

ENI Brake Fluid DOT 4 (SAE J1703, FMVSS116)

### **! WARNING !**

Change brake fluid at least once each two years. If you wash your motorcycle often, brake fluid should be changed even more often (once a year), as brake fluid tends to absorb water. Therefore, vapour pockets may form on "old" brake fluids even at low temperatures, causing brake system to fail.

### **! WARNING !**

- Store brake fluid out of reach of children.
- Brake fluid can cause skin irritation. Avoid contact with skin and eyes. If you get brake fluid in your eyes, clear with plenty of water and consult a doctor.

## Checking the brake fluid level – front brake

Brake fluid reservoir is linked with the hand brake cylinder at the handlebar and the reservoir is provided with an inspection glass (1). With the reservoir in horizontal position, the brake fluid level should not drop below the middle of the glass.

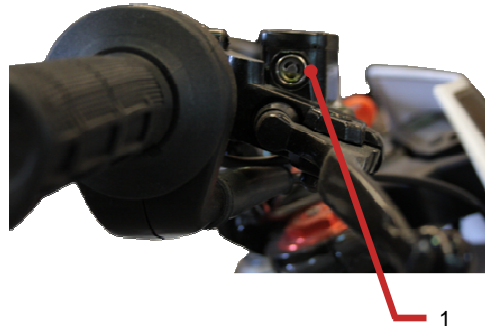

## Refilling front brake fluid reservoir (\*)

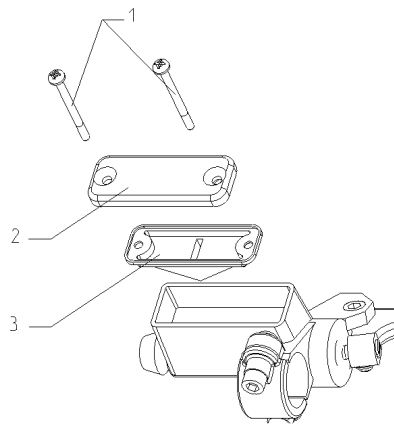

Loosen screws (1), remove cover (2) and membrane (3). Place hand brake cylinder in a horizontal position and fill the brake fluid reservoir up to the MAX mark with clean brake fluid DOT 4. Replace membrane, lid and tighten screws. Clear off spilled or overflowing brake fluid with water.

### **! CAUTION !**

- Don't let brake fluid get in contact with paint; it is an effective paint remover.
- Use only clean brake fluid from a sealed or hermetic closed container.

## Checking front brake pads

The front brake pads can be inspected from below. The linings must have at least 1 mm thickness.

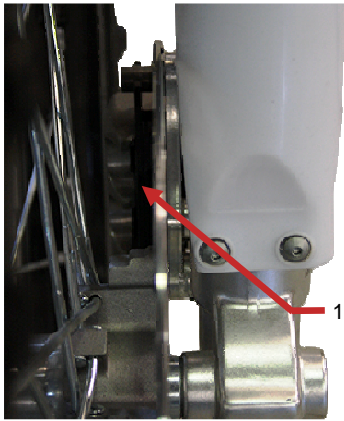

**! WARNING !**

At their most worn point brake pad linings should not be thinner than 1mm, otherwise can lead to braking failure.

**! WARNING !**

If brake pads are replaced too late so that the lining is partly or entirely worn, steel components of brake pad will rub against brake disc, thereby reducing braking effect and destroying brake disc.

**Replacing front brake pads (\*)**

Remove calliper assembly, unscrewing screws (1). Press the brake calliper away from brake disc to put the brake piston in its basic position. Remove clips and the brake pads from the calliper.

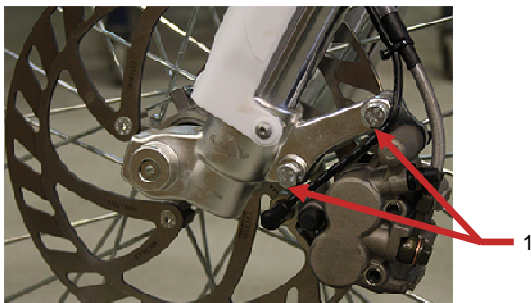

Clean the brake calliper and calliper support with compressed air. Check the sleeves of the guide bolts for damage and grease guide bolts if necessary.

Mount both brake pads and then insert the clips the right way, to allow brake pads to jump off or lose, in order to avoid accidents.

**! WARNING !**

- Keep brake discs free from oil and fatty materials; otherwise braking effect will be strongly reduced.
- Having performed any work on the braking system, one must always actuate hand brake lever or foot brake pedal, to ensure that brake pads will fit against brake disc and pressure is established.

**Changing the basic position of the brake pedal (\*)**

Free play can be changed by turning piston (1).

Measured on the outside, the foot brake pedal must have 3 to 5 mm of free play, before the piston rod can move the piston in the rear brake cylinder.

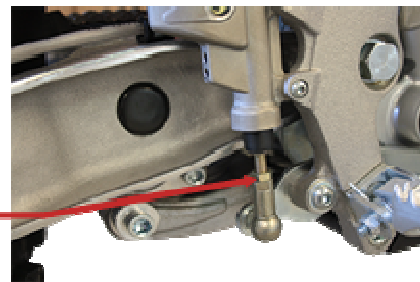

**Checking rear brake fluid level**

The reservoir for the rear disc brake is integrated in brake pump, placed in the right side of the engine, near exhaust pipe.

Brake fluid level must not drop below the "MIN" marking when the vehicle is in an upright position.

**! WARNING !**

If brake fluid level drops below the minimum or brake system has a leak or brake pads are completely worn. In this case, consult an authorized dealer immediately.

### Refilling the rear brake fluid reservoir (\*)

Unscrew the cap (1), diaphragm and add brake fluid DOT 4 until it reaches the MAX mark, then place diaphragm and cap back on. Clear off spilled or overflowing brake fluid with water.

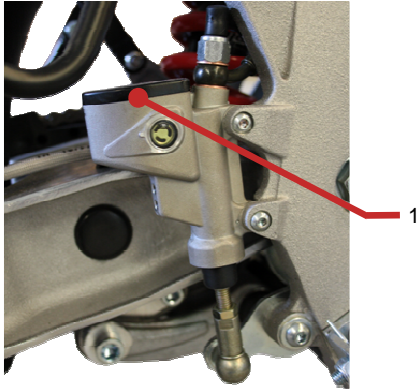

### Checking the rear brake pads (\*)

The brake pads can be inspected from the rear. The thickness of the linings cannot be less than 1mm.

#### **! WARNING !**

At their most worn point brake pad linings should not be thinner than 1mm, otherwise can lead to brake failure.

#### **! CAUTION !**

- If free play is not present, then pressure can build up in the brake system when driving, causing rear wheel to brake. Brake system can overheat and may even completely fail in extreme cases.
- Don't ride with foot pressing rear brake pedal.

#### **! WARNING !**

- Store brake fluid out of reach of children.
- Brake fluid can cause skin irritation. Avoid contact with skin and eyes. If you get brake fluid in your eyes, clear with plenty of water and consult a doctor.

#### **! WARNING !**

If brake pads are replaced too late so that the lining is partly or entirely worn, steel components of brake pad will rub against brake disc, thereby reducing braking effect and destroying brake disc.

#### **! CAUTION !**

- Don't place brake fluid in contact with paint; it is a powerful paint remover
- Use only clean brake fluid or from a sealed container

### Replacing the rear brake pads (\*)

Remove the rear wheel – see “REAR WHEEL REMOVAL” and with a screwdriver push the brake pads to move the pistons into their basic position. Remove clip (1) and then remove brake pads from the calliper. Clean the brake calliper thoroughly with compressed air, insert brake pads and secure them with the clip. Then place rear wheel back on.

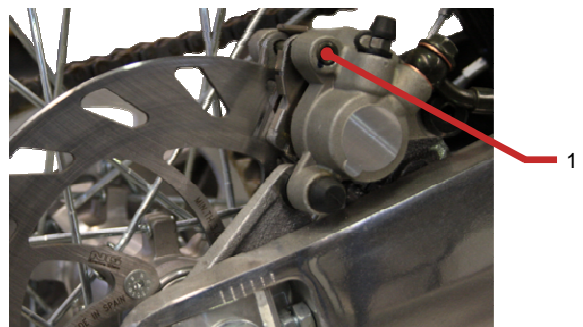

## FRONT WHEEL REMOVAL

### Dismounting and mounting front wheel

To remove the front wheel, jack the motorcycle up on its frame so that the front wheel no longer touches the ground.

Loosen the 2 clamping screws (1) on the right side of the fork, hold the wheel and unscrew the front axle (2). Remove the front wheel carefully from the fork.

Don't take spacers (3) off the hub; these spacers should only be removed when it is necessary to replace wheel bearings.

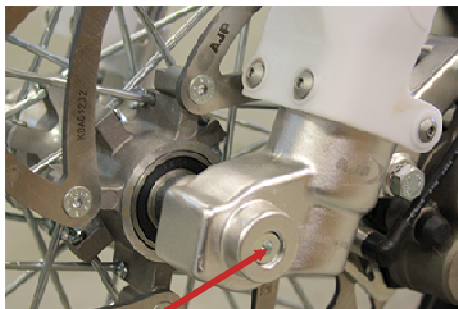
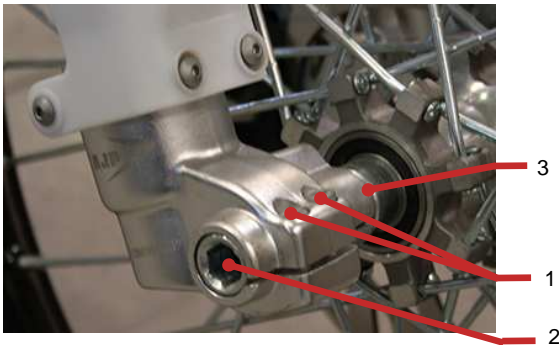

1

### **! CAUTION !**

- Do not operate hand brake lever when front wheel has been removed.

### Front wheel mounting

Place front wheel between front fork sleeves in a way that brake disc is between brake pads.

Tighten front axle or the fixation nut and tight fixation screws.

Check if front wheel rotates freely without any restrain.

Actuate several times front brake lever until you certify that front brake is working.

### **! WARNING !**

After mounting front wheel, operate hand brake lever until pressure point is established.

Keep brake discs free from oil and fatty materials; otherwise braking effect will be strongly reduced.

## REAR WHEEL REMOVAL

### Dismounting and mounting the rear wheel

Jack the motorcycle up on its frame so that the rear wheel no longer touches the ground. Loosen the collar nut (1) in the right side, hold the rear wheel and pull out the wheel spindle (2) by the left side until the rear wheel is free but the brake calliper support is still held in the swing arm.

Push the rear wheel as far forward as possible, take out the chain from the rear sprocket and carefully remove the wheel carefully from the swing arm.

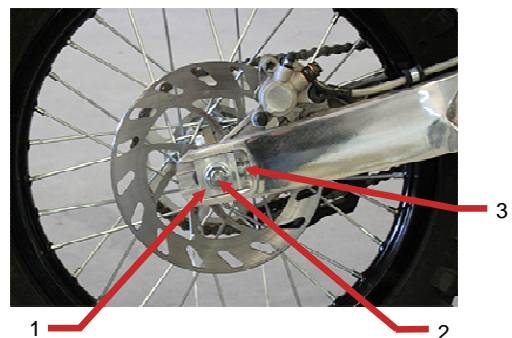

1

2

3

## **! CAUTION !**

Do not operate rear brake pedal when rear wheel has been removed.

Make sure brake disc is always on top when you lay down the wheel, otherwise brake disc can be damaged.

If axle is dismantled, clean the thread of the wheel spindle and apply a new coat of grease to prevent thread from jamming.

To mount rear wheel, follow the above procedure in reverse order, being careful to place the brake disc correctly between the brake pads. Make sure that rear wheel guides are touching rear wheel adjusters (3) and that both have same setting.

## **! WARNING !**

After mounting rear wheel, operate brake pedal until pressure point is established.

Keep brake discs free from oil and fatty materials, otherwise braking effect will be strongly reduced.

Tighten the collar nut with required torque. A loose wheel spindle may lead to unstable behaviour of your motorcycle.

## **TIRES**

### **Tires, air pressure**

Tire type, its condition and air pressure, affect the way your motorcycle behaves; therefore, they must be checked whenever you are getting ready to go anywhere on your motorcycle.

- Tire size can be found in the technical specifications and registration documents.

- Before leaving, check tires for punctures and nails or other sharp objects that might have become embedded in them. Refer to specific regulations in your country for minimum tire tread requirements.

- Tire pressure should be checked regularly on a "cold" tyre. Proper pressure ensures optimum driving comfort and extends the life of your tyres.

Model		Pneu	Pressure in bar (psi)
MX MX PRO	Only driver	Front	1.5(21)
		Rear	1.5(21)
Enduro Enduro PRO	Only driver	Front	1.5(21)
		Rear	1.75(25)
	Driver + passenger	Front	1.5(21)
		Rear	1.75(25)
Trail Supermoto Supermoto PRO	Only driver	Front	1.75(25)
		Rear	2.0(28)
	Driver + passenger	Front	1.75(25)
		Rear	2.25(32)

These pressure values are indicated for road use. For an off-road use on MX and Enduro versions, we recommend a lower pressure, to assure traction. In these conditions, we recommend 1,0 bar (14 psi) in both tires.

Please consider that these are indicative values and that correct pressure depends on the ground where you drive.

## **! WARNING !**

- Do not mount tires that are not approved by AJP. Other tires could have adverse effects on the way your motorcycle behaves.

- Front and rear wheels may only be fitted with tires having same layout. Use homologated tires.

- For your own safety replace damaged tires immediately.

- Worn tires can have a negative effect on how your motorcycle performs, especially on wet surfaces.

- If air pressure is too low, abnormal wear and overheating of tire can result.

## SPOKE TIGHTNESS

### Checking spoke tension

Correct spoke tension is very important for the stability of the wheels and thus for riding safety. A loose spoke causes the wheel to become unbalanced and before long other spokes will have come loose. Check spoke tension, especially on a new motorcycle, in regular intervals. If necessary, have the spokes retightened and the wheel to correct by an AJP dealer.

### **! WARNING !**

Spokes can tear if you continue to ride with them loose. This may lead to an unstable handling of your motorcycle.

## BATTERY

Battery has a closed system and therefore requires no maintenance (MF). It is not necessary to check the electrolyte level or to refill water; simply keep the battery poles clean and slightly greased with acid-free grease if necessary.

To access battery, remove the front right plastic cover.

To remove the battery, first disconnect the negative and then the positive pole of the battery and then unhitch rubber band.

When replacing, connect first the positive and then the negative pole.

When preparing the motorcycle for a longer period of standstill, remove the battery and recharge it every month in a slow charge. Storage temperature: 0-35°C. Do not expose it to direct sun radiation.

### **! CAUTION !**

- Never reverse polarity, otherwise battery and rectifier-regulator will be destroyed

- Never disconnect battery while engine is running. This will destroy the rectifier-regulator.

### **! WARNING !**

- If electrolyte (sulphuric acid) leaks from battery, proceed with great care. Electrolyte can cause severe burns.

- In case of skin contact, clear thoroughly with water.

- In case of contact with eyes, thoroughly apply them water for at least 15 minutes and immediately consult a doctor.

- Battery is a closed model but can nevertheless emit explosive gases. Avoid sparks and open fire near the battery

- Defected batteries must be stored out of reach of children. Ensure proper disposal of discarded batteries.

## FUSE

The fuse is disposed underneath the seat. Having removed the seat you will be able to see the fuse.

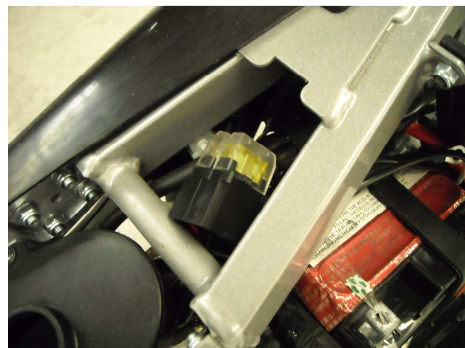

The fuse capacity is 20 Ampere, except for MX versions, which is 10 Ampere.

Always carry an extra fuse in the fuse holder with you whenever you are riding the motorcycle.

Replace a blown fuse only with an equivalent one. If a new fuse that has just been set in gets blown again, you are strongly advised to have it inspected by an AJP dealer.

## **! CAUTION !**

Under no circumstances is a stronger fuse allowed to be set in or a fuse to be "repaired". An inadequate treatment could damage the whole electrical installation.

## **LIGHT BULB REPLACEMENT**

### **Replacing headlight lamp/parking light lamp**

Loosen both rubber bands and tilt headlight mask to the front. Pull the parking light lamp with holder carefully out of the reflector. Pull connector off the headlamp and remove rubber cap. Disengage retaining clip and take bulb out of the reflector.



When placing a new lamp, do not touch the glass body of the lamp so it remains free from fat. Engage retaining clip and mount rubber cap and connector. Reinsert parking light lamp together with holder and fix the mask by means of the rubber bands.

Use only 12V25/35W BA20d lamps.

Note: rear light is a set of LEDs and does not allow for replacing, because they are unchangeable. In the event of a presence or stop light failure, it is necessary to replace all the rear spoiler assembly.

## **AIR FILTER**

### **Cleaning air-filter (\*)**

A dirty air filter restricts airflow rate, reduces the engine performance and increases fuel consumption, therefore clean it in regular intervals.

Note: air filter requires a more frequent service as indicated on MAINTENANCE SCHEDULE, if motorcycle is used on dusty, muddy or wet conditions (off road use)

For this purpose, remove drivers seat, by unscrewing to screw (1) in the back of the seat and pull it in to rear direction. Then remove air filter's cover by unscrewing fixation screw (2).

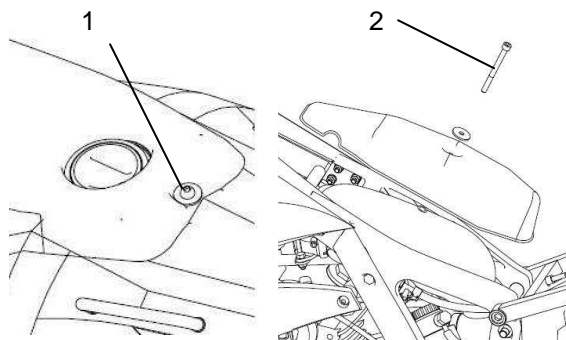

Thoroughly wash the air-filter in special cleaning fluid and allow it to dry well. Oil the dry air filter with high-grade filter oil and clean the air filter box.

For extra security, apply grease on the back side of the filter, which mates with air filter box.

Mount the filter together with the filter bracket and fix them with the rubber washer and the screw.

## **! WARNING !**

Do not clean air-filter with fuel or petroleum since these will damage the foam.

Never start your motorcycle without air filter, otherwise dust or dirt may penetrate in the engine and cause damage or severe wear.

## FUEL FILTER

Fuel filter is placed between right beam and carburettor, below driver's seat. It should be replaced whenever there is dirt on it, because dirt can reduce or block fuel flow producing loss of power or irregular engine functioning.

## THROTTLE CABLE

### Adjusting throttle cable (\*)

The throttle grip should always provide for a backlash of 2-6mm, measured in the adjusting screw outside the throttle grip. Besides, with the engine running, the idling speed must not change if you turn the handlebar all the way to the left or right.

To adjust throttle cable, draw back dust protection, loosen the counter nut (1) and turn the adjusting screw accordingly (2). Tighten the counter nut and check whether the throttle grip can be actuated smoothly.

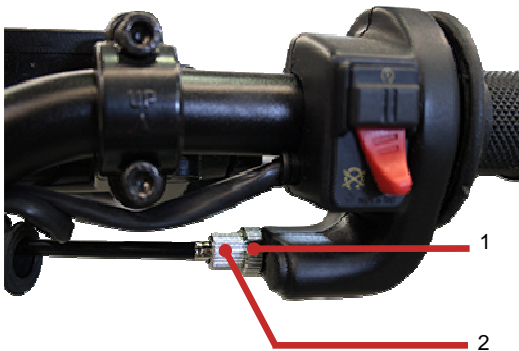

## IDLING

### Adjust idling

Idling adjustment of the carburettor strongly affects the engine starting behaviour, that is, an engine whose idling speed is adjusted correctly will be easier to start.

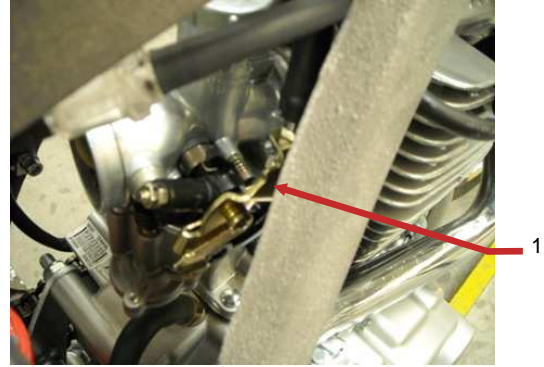

The idle speed is controlled by means of the mixture control screw (1). Turning the mixture control screw clockwise reduces the fuel quantity (lean mixture); turning counter-clockwise increases the fuel quantity (rich mixture).

## ENGINE OIL

### Recommendation

Use only branded oil for four stroke engines, to ensure a long engine life. Use only oils meeting or surpassing the quality requirements of API classes SF or SG:

### Recommended oil:

ENI / Agip i-Ride moto SAE 20W-50  
Specification: API SG JASO MA, MA2.

### Checking engine oil level

Engine oil level is checked in a glass placed in front of rear brake pedal. Level should be between Min and Max.

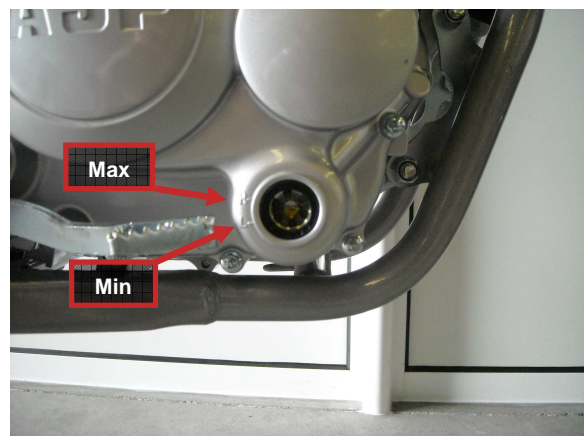

If oil level is below Min, oil must be refilled immediately. If you check that



engine is losing oil (for instance at oil radiator or oil tubes in 200/240 cc engines), contact your AJP dealer immediately.

### **! WARNING !**

- Insufficient engine oil or poor quality may cause severe damage to the engine.
- Never operate your motorcycle with low engine oil level or with non-adequate engine oil quality.

### **! CAUTION !**

Engine oil level should be checked daily or before any ride. If necessary you should add oil to keep always oil level between maximum H mark and lower L mark.

### **! WARNING !**

On PR3 200/240, if any oil pipe or oil radiator is damaged and present leak, engine should be immediately stopped. Otherwise serious damages in engine will happen due to lack of oil in lubricating circuit.

### **Changing engine oil (\*)**

Engine oil has to be changed with the engine being at operating temperature.

### **! CAUTION !**

An engine at operating temperature and engine oil it contains are very hot. Please take all cares to avoid burning yourself.

Place the motorcycle on a horizontal surface, remove the plug and allow the oil to drain into a receptacle. Never drain used oil to the ground, waste, water lines or sewage.

Take out the oil drain together with oil filter, clean these components carefully and blow with compressed air. Check o-ring and sealing and replace them if necessary.

Once the entire oil has been drained, clean the sealing surface, mount the oil drain together with spring, oil filter and sealing on the right position and tighten up to 15Nm (1,5 Kg.m).

Screw aluminium drain carefully to avoid damaging carter's thread.

Remove the oil dipstick (1) and fill in with following quantities:

- 1 litre at engine 125
- 1,1 litres at engine 200 or 240

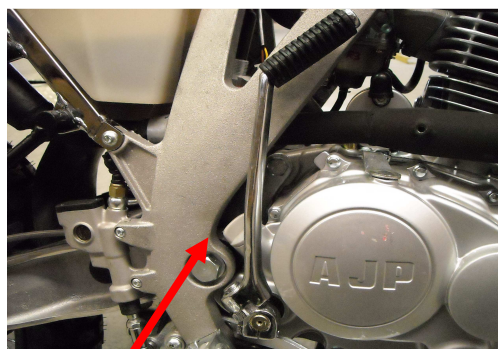

1

### **! CAUTION !**

When removing oil dipstick, be careful not to let any dirt enter the engine.

If oil level drops quickly, do not operate your motorcycle. Take your motorcycle to an authorized AJP dealer immediately, to a full check of engine.

Start the engine and check for leaks.

Finally, check the engine oil level and, if necessary, correct it.

### **EXHAUST SYSTEM**

MX e MX PRO

Requires regular maintenance, the more frequent and severe is the riding of your motorcycle. **The silencer fibre in is interior should be replaced each 3.000 Km or 50 hours of use.** If not, noise level will reach illegal and disturbing levels and also may destroy muffler parts.

## MOTORCYCLE CLEANING

Clean your motorcycle regularly in order to maintain the beauty of its plastic surfaces and avoid corrosion. The best manner would be to use warm water that has been mixed with a normal brand-name washing detergent and a sponge. The hard dirt can be removed before washing with the help of a soft water jet.

### **! CAUTION !**

Never clean your motorcycle with a high-pressured cleaner or a high-pressured water jet. Water could run into electrical components, connectors, cables, bearings, carburettor, etc, can cause operations mal-functions or lead to premature destruction of these parts.

- Use regular brand-name detergents to clean the motorcycle. Especially dirty parts should be cleaned additionally with the help of a paintbrush.
- Before cleaning with water, plug the exhaust pipe to prevent water going inside.
- After the motorcycle has been cleaned with a soft water jet, it should be dried with air pressure and a cloth. Take a short drive until the engine has reached the working temperature and also use the brakes. By warming these components, the residual water can evaporate from inaccessible parts of engine and brakes.
- Once the motorcycle has cooled down, oil or grease all sliding and bearing points; lubricate chain with chain spray.
- To avoid any malfunction of the electric system, you should treat emergency off button, light switch and socket connectors with a contact spray.

## CONSERVATION FOR WINTER OPERATION

In the event that the motorcycle is also used in winter and on roads where one

has to expect salt spraying, you will have to take precautions against the aggressive road salt.

- Clean motorcycle thoroughly and let it dry after each riding.
- Treat engine, carburettor, swing arm and all other bare galvanized parts (except for brake discs) with a wax-based anti-corrosion agent.

## STORAGE PROCEDURES

Should you desire to make a pause over a long period of time (more than one month), please observe the following instructions:

- Clean the motorcycle thoroughly (see CLEANING).
- Change engine oil and oil filter.
- Remove spark plug and fill in approx. 5ccm of engine oil into the cylinder through the opening. Actuate kick-starter 10 times in order to distribute the oil into the cylinder walls and mount the spark plug.
- Remove the fuel into an appropriate container.
- Correct the tyre pressure.
- Lubricate pivot points of control levers, foot rests, etc. as well as the chain.
- Service the shock absorber linkage.
- Disassemble and charge battery (see BATTERY)
- Storage place should be dry and not subject to excessive temperature fluctuations. – Cover the motorcycle with a blanket. Do not use air impermeable materials as a possible humidity might not be able to escape and could cause corrosion.

### **! CAUTION !**

Don't let engine run for a short time period. Engine would not get warmed enough and developed water vapour would condensate when cooling, causing valve and exhaust corrosion

### **RE-INITIATION AFTER STORAGE:**

- Mount the charged battery (check polarity).
- Fill up the tank with fresh fuel.
- Check motorcycle as before each start (see DRIVING INSTRUCTIONS)
- Take a short, careful test ride first and check all of your motorcycle systems.

## TECHNICAL SPECIFICATIONS

Engine	PR3 125	PR3 200	PR3 240
Type	1 Cylinder, 4 strokes, SOHC, 2 Valves		
Displacement	124 cm <sup>3</sup>	198 cm <sup>3</sup>	233 cm <sup>3</sup>
Bore x stroke	56,5 x 49,5 mm	73 x 59,5	69 x 62.5
Cooling	Air	Air + oil radiator	
Power	9,3KW (12,6 cv) / 8500 r.p.m.	13,2KW (18 Cv) / 8000 r.p.m.	14.7 KW (20 CV) / 8000 r.p.m
Torque	8,5 N.m / 8000 r.p.m.	15,5N.m / 7000 r.p.m.	18 N.m / 7000 r.p.m
Carburettor	Walbro 30 mm		
Start	Electric + kick starter		
Intake valve clearance	0,05 mm		
Exhaust valve clearance	0,08 mm		
Min jet	45		
Max jet	115		
Carburetor screw adjustment	2 ½		
Needle position	3 <sup>a</sup>		
Intake valve diameter	30 mm	31,5 mm	
Exhaust valve diaeter	25 mm	26 mm	
Gearbox	5 speeds		
Frame	Aluminium double beam + steel double cradle		
Front brake	Disc 260 mm, double piston calliper		
Rear brake	Disc 220 mm, simple piston calliper		
Seat height	840 mm		
Wheel base	1320 mm		
Weight	99 Kg	100 Kg	
Fuel tank	7 litres		
Fuel pump	Paioli (vacuum type)		
Engine oil	ENI i-Ride SAE 20W-50 API SF or SG		
Engine oil volume	1 litre	1,1 litres	
Spark plug	LG D8TC (Champion A8YC or NGK DR8ES)		
Battery	YTX5L-BS (12V 4Ah)		
Fuse	20A (10A MX)		
Road/high beam light	12V35/35W BA20d		
Presence light	12V 5WBA 9S		
Rear light	LEDs		
Blinkers lght	12V10W BA 15S		
Axle gear	15 teeth		
Wheel gear	46 teeth		
Chain	½"x5/16" (428H/124L)		

	TRAIL	ENDURO (PRO)	SUPERMOTO (PRO)	MX (PRO)
Front suspension	Up Side Down 38 mm, Adjustable			
Rear suspension	Direct system	Progressive system ( ZF SACHS shock absorber, Adjustable)		
Front tire	2.75 - 19	MAXXIS 70/100 - 19	MICHELIN 100/80 - 17	MICHELIN 70/100 - 19
Rear tire	3.25 - 17	MAXXIS 100/100 - 17	MICHELIN 130/70 - 17	MICHELIN 90/100 - 16