



¡ Enhorabuena por su elección !

Queremos darle la bienvenida a Vertigo Motors y compartir con usted nuestra experiencia y pasión por el trial, el diseño, la técnica, la innovación y la investigación.

Vertigo nace de la inquietud de evolucionar las motos de trial para llevarlas al siguiente nivel.

En Vertigo soñamos cual sería la moto ideal para la práctica de nuestra pasión, sin distinciones entre aficionados o profesionales, una moto revolucionaria pensada para usted.

Desde ahora usted entra a formar parte de nuestro equipo, integrándose con el mejor equipo técnico, pilotos, apasionados del motor y los mejores profesionales en cada especialidad. Todos con un denominador común: **Pasión y Experiencia**.

En Vertigo, además, queremos ofrecerle la posibilidad de practicar el trial en un área privada reservada (**Noassar**), ubicada en Camprodón dentro del complejo hotelero Hotel Puig-Francó y en el que podrá disfrutar de su pasión por el trial.

Para más información visite la web: www.puigfranco.es

Con este manual le proporcionamos los datos, tareas de mantenimiento y reglajes básicos que usted mismo podrá realizar en su nueva Vertigo. Asimismo, en su Concesionario Oficial Vertigo Motors encontrará el equipo de expertos que podrán asesorarle sobre todos los temas relacionados con su motocicleta y sus complementos.

Le invitamos a formar parte de nuestra historia y de nuestro éxito.



Presentación y agradecimiento	03
Simbología utilizada al manual	06
Consejos de seguridad	07
Larga inactividad de la motocicleta	08
Identificación de la motocicleta	09
Identificación elementos de la motocicleta	10-11
Elementos básicos para arrancar la motocicleta	12-14
Mantenimiento	
Manillar	15
Maneta del freno delantero	16
Maneta del embrague	16
Juego de la maneta del freno delantero	17
Juego de la maneta del embrague	17
Líquido de la maneta del freno delantero	18
Líquido de la maneta del embrague	18
Líquido del freno trasero	19
3 posiciones de embrague	19
Filtro del aire	20
Bujía	21-22
Mantenimiento de la rejilla del radiador	22
Líquido refrigerante	23
Batería	23
Pastillas del freno delantero	24
Pastillas del freno trasero	24
Amortiguación delantera	25
Amortiguador	26-27
Cadena	28
Neumáticos	29

Aceite del motor	29
Lubricado	30
Pares de apriete	31
Tabla de mantenimiento	32-33
Homologación	34
Datos técnicos	35-38



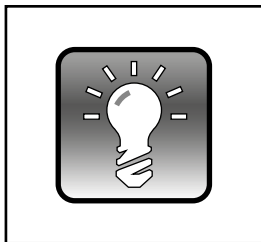

CONSEJO

Con este símbolo queremos darle indicaciones para facilitarle las operaciones de mantenimiento que desee realizar.

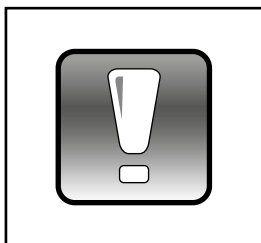

ADVERTENCIA

Con este símbolo queremos avisarle de posibles situaciones de peligro que pueda encontrar en algunas operaciones descritas en este manual.

Cualquier operación de mantenimiento que realice, a banda de los consejos o advertencias que se te puedan indicar, utilice siempre el sentido común para no poner en riesgo su integridad física o la de otras personas que le estén ayudando.



Antes de la utilización de esta moto familiarícese con ella, sitúe e identifique todos los elementos básicos para la conducción.

Lea atentamente todos y cada uno de los apartados de este manual.

Esta moto ha sido fabricada para uso exclusivo del trial por lo que no podrá llevar a un segundo pasajero.

Realice las operaciones de mantenimiento descritas en este manual y en el momento que se indica para que su moto se mantenga en buen estado el máximo de tiempo posible.

Use equipación adecuada para la practica del Trial que garantice su integridad (casco, ropa adecuada, protecciones, etc...).

Utilice la moto de forma progresiva hasta alcanzar su máximo rendimiento.

Evite arrancar la moto con el caballete puesto.

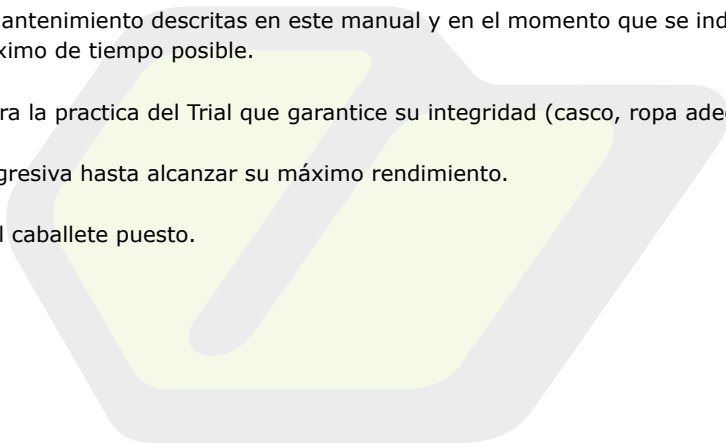

Es necesario adoptar ciertas medidas para garantizar el buen mantenimiento de la moto en caso de larga inactividad del vehículo:

- Desconectar la batería si la inactividad supera los 10 días.
- Proceder a un limpieza completa de la moto antes de su almacenamiento.
- Reducir la presión de los neumáticos.
- Cubrir la moto con una funda para evitar el polvo y la suciedad.

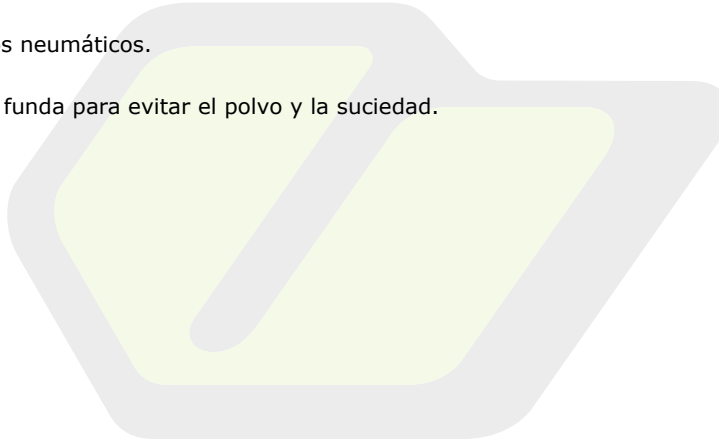



IDENTIFICACIÓN CHASIS

Anote en el siguiente recuadro el número de chasis que encontrará en la pipa de dirección de su moto como se aprecia en la fotografía.

Este número lo necesitará para la solicitud de recambios o en caso de tramitaciones.

NÚMERO DE CHASIS



IDENTIFICACIÓN MOTOR

Anote en el siguiente recuadro el número de motor que encontrará en la parte inferior-derecha de su motor como se aprecia en la fotografía.

Este número lo necesitarás para la solicitud de recambios o en caso de tramitaciones.

NÚMERO DE MOTOR



IDENTIFICACIÓN ELEMENTOS DE LA MOTO

VISTA LADO DERECHO

Identifique los siguientes elementos en su moto para familiarizarse con ella antes de la puesta en marcha.



1 Escape

2 Botón encendido / paro

3 Tapón radiador

4 Palanca de arranque

5 Pedal de freno trasero

6 Disco de freno trasero



IDENTIFICACIÓN ELEMENTOS DE LA MOTO

VISTA LADO IZQUIERDO

Identifique los siguientes elementos en su moto para familiarizarse con ella antes de la puesta en marcha.



7 Suspensión delantera

9 Plato de arrastre

11 Disco de freno delantero

8 Silencioso

10 Palanca del cambio

12 Llenado depósito de gasolina



DEPÓSITO DE GASOLINA

El acceso al depósito de gasolina se encuentra en el centro de la moto.

Gire la anilla (A) hacia la izquierda y tire la tapa hacia atrás para acceder al tapón de llenado.

Utilice siempre gasolina 95oct o 98oct con una mezcla de aceite 2T de 0'75%.

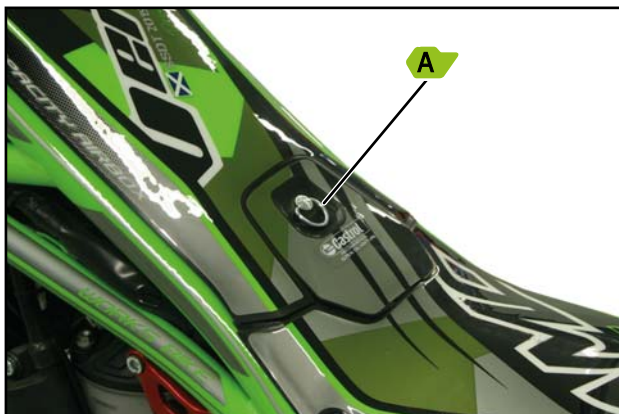

Retire cualquier resto de gasolina que haya tenido contacto con componentes de la moto para evitar que sean dañadas.



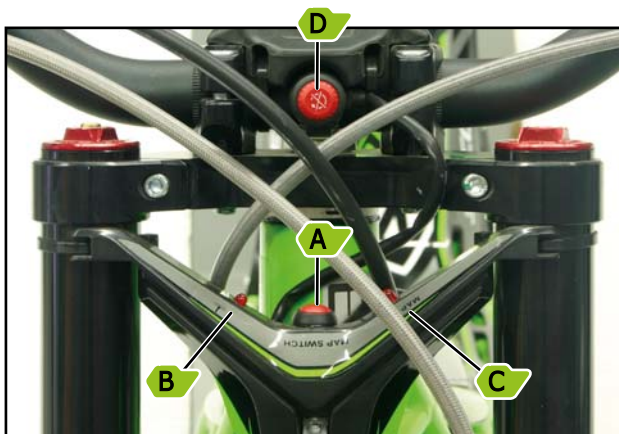

- A - Selector de mapas
- B - Testigo de temperatura
- C - Testigo de mapa
- D - Contacto / Botón de paro

SELECCIÓN DE MAPAS

Para proceder a arrancar la moto debe pulsar el botón de paro (D) para encender la ECU, el LED MAP se iluminará y dispone de 15 segundos para arrancar la moto, si no la ECU se apagará y deberá repetir el proceso.

Para elegir mapa de motor (C) dispone de 4 opciones diferentes:

Mapa 1: Es el mapa standard que utiliza la moto.
El LED se ilumina con una frecuencia de un destello.

Mapa 2: Mapa un poco más rico que el standard.
El LED se ilumina con frecuencia de dos destellos.

Mapa 3: Mapa más rico.
El LED se ilumina con frecuencia de tres destellos.

Mapa 4: Mapa seco recomendable para su uso en altitud.
El LED se ilumina con frecuencia de 4 destellos.

Debe tener en cuenta que cuando apague la moto o se le cale, al volver a arrancar la moto, el mapa siempre volverá al standard (Mapa 1).

El led de temperatura (B) nos informa cuándo hay sobrecalentamiento de la moto.

Para apagar el motor mantener pulsado el botón de paro (D).





PEDAL DE ARRANQUE

La arrancada de la moto se realiza a través del pedal de arranque situado a la derecha de la moto.

Gire el pedal para poder apoyar el pie y empuje hacia abajo energicamente.

Retire el pie cuando el motor haya arrancado para no dañarlo y retorne el pedal a su posición de plegado.



Accione el pedal de arranque SÓLO con el pie.

DESCONEXIÓN HOMBRE AL AGUA

Si acopla un sistema de hombre al agua a su moto, es necesario que una vez parada la moto, vuelva a poner el imán en su sitio para evitar la descarga de la batería de la moto.

Sin el imán, el contacto de la moto seguirá encendido pasados 15 segundos provocando la descarga de la batería.



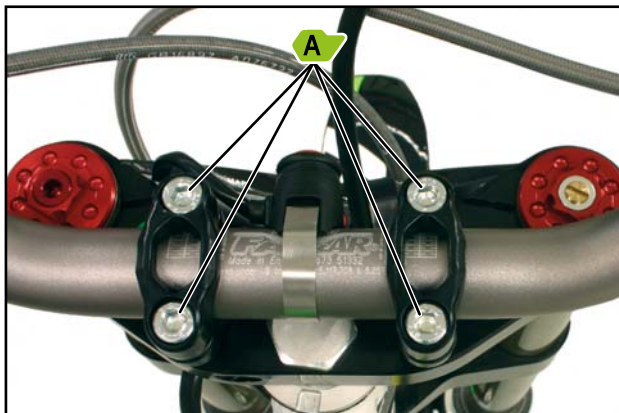

MANILLAR

Ajuste la **inclinación del manillar** que se adapte mejor a su estilo de conducción.

- Afloje los 4 tornillos (A).
- Sitúe el manillar en la posición adecuada para usted.
- Atornille los 4 tornillos (A).



Asegúrese que el manillar está centrado antes de apretar los tornillos.



Apriete los cuatro tornillos de forma cruzada y por igual. Le recomendamos que realice un ajuste de los mandos del manillar.

Ajuste la **distancia del manillar**.

Dispone de 4 posiciones diferentes para adaptar el manillar a su gusto.

Invirtiendo la posición de las bridas de manillar puede acercar o alejar el manillar.

Modificando el anclaje de la brida de manillar a la platina con las dos posiciones disponibles, puede alejar o acercar el manillar.



Debe asegurarse que aprieta los tornillos al par de apriete mostrado en la tabla de aprietes para evitar posibles accidentes.



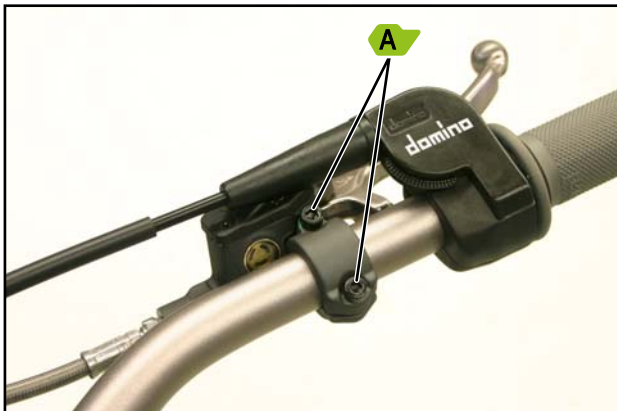

MANETA FRENO DELANTERO

Ajuste la posición de la maneta que se adapte mejor a su estilo de conducción.

- Afloje los 2 tornillos (A).
- Incline la maneta hasta una posición adecuada para usted.
- Atornille los 2 tornillos (A).



Apriete los dos tornillos por igual.

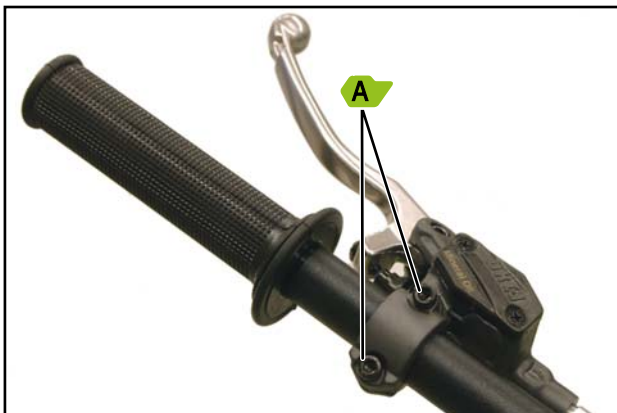

MANETA DEL EMBRAGUE

Ajuste la posición de la maneta del embrague que se adapte mejor a su estilo de conducción.

- Afloje los 2 tornillos (A).
- Incline la maneta hasta una posición adecuada para usted.
- Atornille los 2 tornillos (A).



Apriete los dos tornillos por igual.



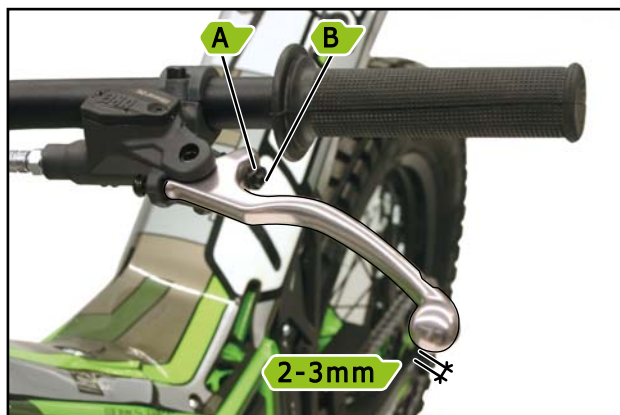
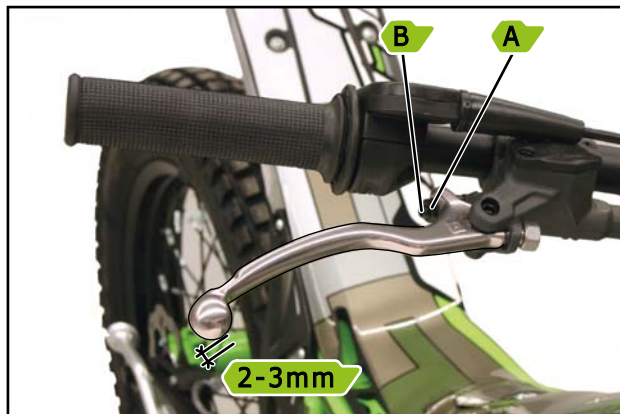

JUEGO DE LA MANETA FRENO DELANTERO

La maneta del freno delantero debe tener un juego mínimo sin actuar. Realice los siguientes pasos para mantener esta tolerancia.

- Afloje la tuerca de fijación (A).
- Ajuste el juego libre con el eje roscado interior (B).
- Fije la posición con la tuerca (A).



La tolerancia debe estar entre 2 y 3mm.

JUEGO DE LA MANETA DEL EMBRAGUE

La maneta del embrague debe tener un juego mínimo sin actuar. Realice los siguientes pasos para mantener esta tolerancia.

- Afloje la tuerca de fijación (A).
- Ajuste el juego libre con el eje roscado interior (B).
- Fije la posición con la tuerca (A).



La tolerancia debe estar entre 2 y 3mm.



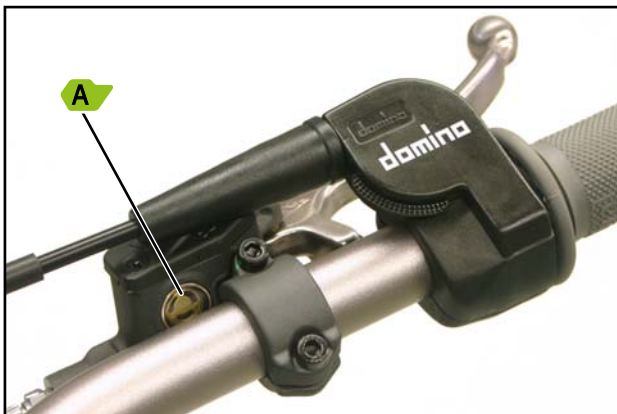

LÍQUIDO DEL FRENO DELANTERO

El depósito del líquido de freno delantero incorpora una mirilla (A) para poder verificar el nivel del líquido. Siempre se debe ver líquido en la mirilla para garantizar nivel óptimo del líquido de freno delantero.

Tipo de líquido de freno: DOT 4



Retire cualquier resto de líquido que haya tenido contacto con componentes de la moto para evitar que sean dañadas.



Para una sustitución total, diríjase a un concesionario oficial Vertigo.

LÍQUIDO MANETA DEL EMBRAGUE

Para comprobar el nivel del líquido de la maneta debe retirar la tapa y el fuelle del depósito. Compruebe que el nivel de aceite hasta la mitad del depósito y rellénelo si está por debajo.

Tipo de líquido del embrague: Aceite mineral.



Retire cualquier resto de líquido que haya tenido contacto con componentes de la moto para evitar que sean dañadas.



Para una sustitución total, diríjase a un concesionario oficial Vertigo.





LÍQUIDO DEL FRENO TRASERO

El depósito del líquido de freno trasero incorpora una mirilla (A) para poder verificar el nivel del líquido.

Siempre se debe ver líquido en la mirilla para garantizar nivel óptimo del líquido de freno trasero.

Tipo de líquido de freno: DOT 4



Para una sustitución total, diríjase a un concesionario oficial Vertigo.

3 POSICIONES DE EMBRAGUE

Con el fin de alargar la vida útil del embrague, usted dispone de 3 posiciones diferentes para el tacto del embrague, si el desgaste de los discos provoca deslizamiento, puede mover el aro verde (A) a la posición 2 o 3 para mejorar la reactividad del embrague.

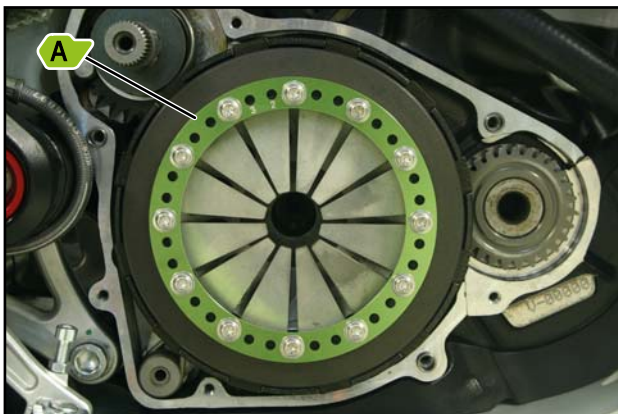

Para esta operación, diríjase a un concesionario oficial Vertigo.



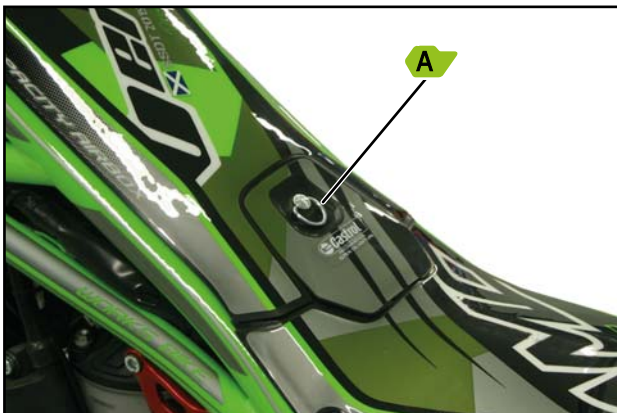

FILTRO DEL AIRE

Para acceder al filtro del aire debe retirar la tapa del filtro.

Primero tendrá que abrir la tapa de acceso al depósito de gasolina girando la anilla (A).

Para una correcta limpieza utilice agua con detergente y engrase el filtro con aceite especial para filtros de aire.



Si utiliza la moto en zonas con mucho polvo acorte el tiempo de limpieza recomendado en la tabla de mantenimiento.





BUJÍA

Para acceder a la bujía retire primero el filtro de aire (ver apartado anterior).

A continuación, retire el tornillo (A) situado en la parte superior a través del orificio de la caja del filtro.

Tire hacia arriba para retirar la caja del filtro (B).

Retire la pipa de la bujía.

Con una llave de bujías de 19, desmontar la bujía y sustituirla si es necesario.

Proceder inversamente para su montaje.



Antes de retirar la bujía asegúrese que el motor se ha enfriado.





Verifique a menudo el estado de la bujía para saber si el motor realiza correctamente la combustión.

Tipo de bujía: BPMR6A

Verifique también que la distancia entre el electrodo y el arco debe ser de 0,7 mm.



MANTENIMIENTO REJILLA DEL RADIADOR

Para evitar un sobrecalentamiento de la moto, la moto equipa un sensor de temperatura y un led que indica cuándo la temperatura del motor sobrepasa el límite de funcionamiento. Deberá parar la moto y verificar que la rejilla y el radiador están libres de barro y suciedad así como comprobar cualquier pérdida de refrigerante. Proceder a su limpieza y pasado unos minutos encender la moto y comprobar que el LED no se encienda.



Si el problema persiste, diríjase a nuestra red de concesionarios para su reparación.





LÍQUIDO REFRIGERANTE

Retire el tornillo de llenado (A) del líquido refrigerante para comprobar que el nivel es el adecuado.

Capacidad total: 600 ml

Tipo de refrigerante: Castrol Radicool SF Premix.



Antes de retirar el tornillo de llenado asegúrese que el líquido refrigerante se haya enfriado.
Utilice siempre líquido refrigerante especial -37°.



Para una sustitución total, diríjase a un concesionario oficial Vertigo.

BATERÍA

La batería de 8,4V se encuentra ubicada dentro de la caja del filtro de aire, en la parte superior.

Para acceder a ella es necesario retirar la tapa del filtro de aire (ver apartado).

La batería utilizada en esta moto es recargable.





PASTILLAS DEL FRENO DELANTERO

La pinza de freno delantero permite una visualización del estado de las pastillas de frenado.

Recuerde que para garantizar una correcta frenada las pastillas no deben estar por debajo de 2mm.

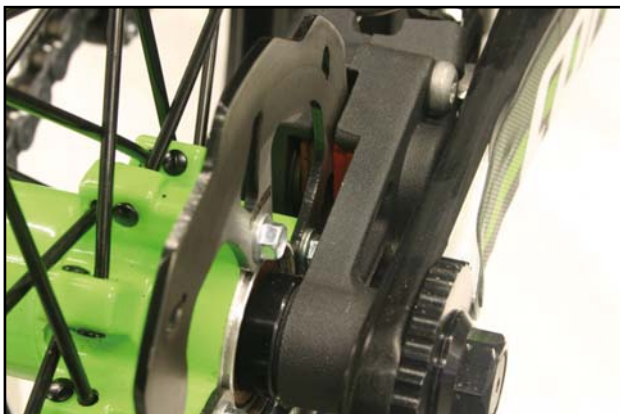

PASTILLAS DEL FRENO TRASERO

La pinza de freno trasero permite una visualización del estado de las pastillas de frenado.

Recuerde que para garantizar una correcta frenada las pastillas no deben estar por debajo de 2mm.



AMORTIGUACIÓN DELANTERA

La suspensión delantera está formada por dos barras de suspensión. Cada una de ellas son regulables permitiendo así, regular la dureza como la velocidad de absorción y retorno.



BARRA IZQUIERDA (A)

Con el tornillo superior podrá regular la precarga del amortiguador.

Gire hacia la izquierda para suavizar o la derecha para endurecer la suspensión.

BARRA DERECHA (B)

Con el tornillo superior podrá regular la velocidad de absorción y de retorno de la suspensión.

Gire hacia la izquierda para ralentizar o hacia la derecha para acelerar la absorción o retorno de la suspensión.



AMORTIGUADOR

La amortiguación trasera permite tres tipos de regulación.

- **Regulación de la precarga** del muelle del amortiguador (A).

El amortiguador incorpora dos anillos que le permiten modificar la precarga del muelle del amortiguador. Uno para determinar la posición y otro para fijarla.

- **Regulación de la compresión.**

El acceso a la rueda de regulación está en la parte inferior delantera del basculante.

La rueda púrpura (B) en el amortiguador es el ajustador de compresión. Gire hacia la derecha para aumentar la compresión o en sentido contrario para reducir la compresión.

El número máximo de clicks en el ajustador es 24.



El amortiguador está regulado para un peso entre 70 y 80 Kgs.





- Ajuste del rebote (C)

El ajuste del rebote dispone de 50 "clics" y se encuentra en la parte superior del amortiguador y es regulable mediante un destornillador plano. Girando el tornillo de regulación en sentido horario conseguirá más estabilidad pero perderá tracción, por lo que si desea ganar tracción deberá girar el tornillo en sentido anti-horario.



Manipule con delicadeza los tornillos de regulación, si sobrepasa el límite de regulación puede causar daños severos al amortiguador. Recuerde tomar nota del número de "clics" si modifica el reglaje para así poder volver al reglaje standard si fuera necesario.



CADENA

La cadena de transmisión requiere de una atención continuada para garantizar su duración y estado óptimo.

En la imagen le indicamos el punto de verificación para un correcto tensado el cual, debe estar sobre los 2 cm de distancia.



El ajuste del tensado deberá realizarlo aflojando la tuerca del eje y haciendo girar el eje de rueda con una llave Allen de 8 hasta conseguir el tensado necesario.

Si sustituye la cadena recuerde que el clip de enganche debe ir colocado en sentido contrario de marcha, como le indicamos en la fotografía (B).

Con una cadena nueva las excéntricas (A) deben colocarse en el punto 9.

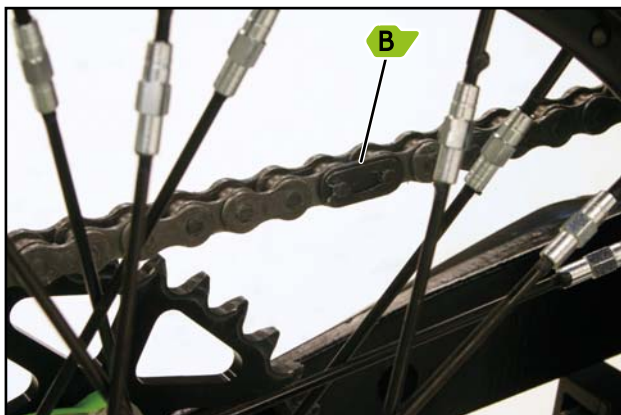



NEUMÁTICOS

Mantenga los neumáticos en buen estado y con la presión adecuada para garantizar una buena adherencia y evitar posibles caídas.

Neumático delantero:

Medida: 1,60 x 21"

Presión: 0,4 bar

Neumático trasero:

Medida: 2,15 x 18"

Presión: 0,3 bar



ACEITE DEL MOTOR

La tapa del cárter derecho incorpora una mirilla para facilitar la comprobación del nivel del aceite del motor.

En la parte superior encontrará el tapón de llenado.



Capacidad total: 375 ml

Tipo de aceite: CASTROL TRANSMAX Z



Para una sustitución total, diríjase a un concesionario oficial Vertigo.



LUBRICADO

Mantenga limpias y lubricadas las zona que le mostramos a continuación:



Cable de gas



Palanca de arranque



Estriberas



Palanca del freno trasero



Puntera de la palanca del cambio



Cadena



COMPONENTE	APRIETE
Semiejes basculante	50 Nm
Triángulo de suspensión	50 Nm
Eje rueda trasero	40 Nm
Disco freno trasero	25 Nm
Eje rueda delantero	50 Nm
Corona trasera	35 Nm
Bridas manillar	25 Nm
Platinas suspensión	12 Nm
Tuerca brida manillar	25 Nm
Platina superior a eje dirección	10 Nm
Esparrago bridas	27 Nm
Pinza freno delantera	17 Nm
Soporte guardabarros delantero	12 Nm
Bastidor	40 Nm

COMPONENTE	APRIETE
Estribos	25 Nm
Escape	12 Nm
Subchasis delantero	25 Nm
Protector cárter	22 Nm
Soporte estribos	25 Nm
Manetas	5 Nm

FRANÇAIS / ENGLISH / ESPAÑOL



TABLA DE MANTENIMIENTO

ELEMENTO	LIMPIEZA	COMPROBACIÓN	AJUSTE	ENGRASE	SUBSTITUCIÓN	OBSERVACIONES
Neumáticos	-	periódica	-	-	por desgaste	Comprobar daños y presiones de hinchado
Llanta delantera/trasera	periódica	periódica	-	-	por daños	Comprobar la tensión de los radios
Sistema de frenado	periódica	periódica	si es necesario	-	por daños	
Desgaste pastillas de freno	periódica	periódica	-	-	por desgaste	
Líquido de frenos	-	periódica	-	-	1 año	
Horquilla suspensión	-	periódica	si es necesario	-	por daños	
Aceite horquilla suspensión	-	periódica	-	-	6 meses	
Amortiguador trasero	-	periódica	si es necesario	-	por daños	
Suspensión trasera	-	periódica	-	cada lavado	por daños	
Corona y piñón de transmisión	periódica	periódica	-	cada lavado	por daños	
Cadena de transmisión	periódica	periódica	si es necesario	cada lavado	por desgaste	
Guía y tensor de cadena	-	periódica	-	-	por desgaste	
Bastidor y subchasis	-	periódica	-	-	por daños	
Cojinete de la dirección	-	-	-	-	por desgaste	Comprobar juego de la dirección



TABLA DE MANTENIMIENTO

ELEMENTO	LIMPIEZA	COMPROBACIÓN	AJUSTE	ENGRASE	SUBSTITUCIÓN	OBSERVACIONES
Tornillería y fijaciones	-	periódica	-	-	por daños	Ver manual de pares de apriete
Sistema de embrague	-	periódica	si es necesario	-	por desgaste	
Líquido de embrague	-	periódica	-	-	1 año	
Aceite de transmisión	-	periódica	-	-	6 meses	
Sistema de refrigeración	periódica	periódica	-	-	por daños	Mantener libre de barro el radiador y la rejilla
Líquido refrigerante	-	periódica	-	-	1 año	
Cilindro - culata	-	50 horas	-	-	por desgaste	
Pistón	-	50 horas	-	-	100 horas	60 horas en uso intensivo de competición
Conexiones eléctricas	-	periódica	-	cada lavado	por daños	Limpiar y engrasar conectores
Batería	-	periódica	-	-	por desgaste	Recargar la batería después de su uso
Cable y mando de acelerador	periódica	periódica	si es necesario	cada lavado	por daños	Mantener el cableado libre y engrasado
Filtro de aire	periódica	periódica	-	cada lavado	por daños	Acortar período en condiciones extremas
Bujía	15 horas	periódica	-	-	por desgaste	
Circuito de carburante	-	periódica	-	-	por daños	Comprobar fugas



Todos los materiales empleados en la fabricación de este vehículo cumplen con la normativa vigente establecida en materia de homologación, incluyendo las piezas específicas que requieren de identificación de homologación.

Les mostramos a continuación los componentes obligatorios para poder circular por la vía pública y que su vehículo de equipar para acudir a la Inspección Técnica de Vehículos:

- Colector de escape catalizado
- Claxon
- Instalación eléctrica
- Retrovisores
- Clausor
- Intermitentes
- Sistema de alumbrado
- Catadióptricos
- Portamatrículas
- Adhesivo identificación del fabricante
- Cuentakilómetros multifunción
- Sonda de velocidad
- Protector salientes
- Sensor bomba de freno delantera
- Sensor bomba de freno trasera



AVISO IMPORTANTE:

Este vehículo se entrega con una serie de piezas adicionales que componen el KIT RACING . Este kit modifica las prestaciones establecidas de la moto y NO está cubierto por la homologación del vehículo.



DATOS TÉCNICOS

DIMENSIONES

Altura asiento	680 mm
Longitud total	2.010 mm
Distancia entre ejes	1.310 mm
Peso	69 kg

RUEDAS

Rueda delantera	Neumático	1,60 x 21"
	Presión	0,4 bar
Rueda trasera (mecanizada)	Neumático	2,15 x 18"
	Presión	0,3 bar



CHASIS

Tipo	Tubular CrMo + Subchasis aluminio	
Basculante	Aluminio doble brazo	
Suspensión delantera	Tech Alu negro	
	Reglaje	Ajustable en compresión, extensión y precarga de muelle
	Recorrido	170 mm
Suspensión trasera	Monoamortiguador hidráulico REIGER	
	Reglaje	Ajustable en compresión, extensión y precarga de muelle
	Recorrido	170 mm

FRENOS

Delantero	Modelo	Braktek Hidráulico con disco de 185mm
	Pinzas	4 pistones
Trasero	Modelo	Braktek Hidráulico con disco de 150mm
	Pinzas	2 pistones



CAPACIDADES

Combustible	Tipo	Gasolina
	Capacidad	2,3 litros
	Mezcla	0,75% aceite 2T
Líquido refrigerante	Tipo	Castrol Radicool SF Premix
	Capacidad	600 ml
Aceite embrague	Tipo	Aceite mineral
Aceite cambio	Tipo	CASTROL TRANSMAX Z
	Capacidad	375 ml
Líquido frenos	Tipo	DOT 4



MOTOR

Cilindrada	300 cc	247 cc
Tipo	2T Monocilíndrico	2T Monocilíndrico
Refrigeración	Por agua	Por agua
Diámetro x carrera	79 x 60 mm	72,5 x 60 mm
Alimentación	Alimentación electrónica	Alimentación electrónica
Compresión	8,7:1	8,8:1
Potencia máxima declarada	31 CV / 9200 rpm	25 CV / 9200 rpm
Par máximo declarado	4,9 kg·m / 4500 rpm	4,0 kg·m / 4500 rpm
Bujía	Modelo	BPMR6A
	Tolerancia	0,7 mm

TRANSMISIÓN

Embrague	Multidisco en baño de aceite	Multidisco en baño de aceite
Cambio	6 marchas	6 marchas
Transmisión secundaria	Cadena (9/38z)	Cadena (9/38z)



Congratulations on your choice !

We would like to welcome you to Vertigo Motors and share with you our experience and passion for trial motorbikes, design, technology, innovation and research.

Vertigo was born out of a desire to see trial motorbikes evolve and to take them to the next level.

At Vertigo we dream about the ideal bike for practising our passion, without distinctions between amateur or professionals, a revolutionary motorbike, designed with you in mind.

Now you have become a part of our team, joining in with the best technical team, riders and motorbike enthusiasts, and the best professionals in each speciality. All with a common denominator: **Passion and Experience**.

In Vertigo, we also offer you the possibility of practising trial riding in a reserved private area (**Noassar**), located in Camprodon within the Puig-Franco Hotel Resort, in which to enjoy your passion for trials.
For further information, visit the website: www.puigfranco.es

With this manual we provide the details, maintenance tasks and basic settings that you can apply yourself to your new Vertigo. Also at your official Vertigo Motors Dealership you will find a team of experts who can advise you on all matters related to your motorcycle and its accessories.

We invite you to form a part of our history and our success.



Presentation and appreciation	39
Symbols	42
Safety tips	43
Long periods of inactivity of the machine	44
Motorcycle identification	45
Identification of elements of the motorcycle	46-47
Basic elements for starting up the motorcycle	48-50
Maintenance	
Handlebar	51
Front brake lever	52
Clutch lever	52
Front brake lever free play	53
Front clutch lever free play	53
Front brake fluid	54
Clutch lever fluid	54
Rear brake fluid	55
3 clutch positions	55
Air filter	56
Spark plug	57-58
Radiator grill maintenance	58
Coolant	59
Battery	59
Front brake pads	60
Rear brake pads	60
Front suspension	61
Shock absorber	62-63
Chain	64
Tyres	65

Engine oil	65
Lubrication	66
Torque tightness settings	67
Maintenance table	68-69
Approval	70
Technical details	71-74

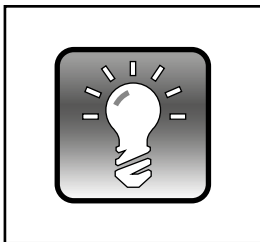

**TIP**

With this symbol our aim is to provide instructions to aid you in any maintenance operations that you wish to perform.

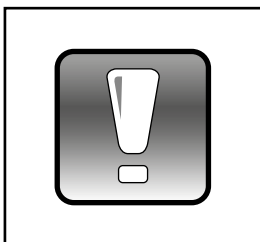
**WARNING**

With this symbol our aim is to alert you to possible dangerous situations that can be found in some operations described in this manual.

In any maintenance operation you perform, apart from the tips or warnings that may be provided, always use common sense to avoid putting yourself, or other people who may be helping you, in harms way.



Before using this motorcycle make yourself familiar with it, taking time to identify all the basic elements for riding it.

Read each and every one of the sections in this manual carefully.

This motorcycle has been manufactured exclusively for trials riding, as it is not been designed to carry a pillion passenger.

Perform the maintenance operations described in this manual and at the time indicated, so that your remains in good condition as long as possible.

Use equipment suitable for practising trial riding that guarantees your safety (helmet, clothing, protections, etc.).

Use the motorcycle progressively until its maximum performance is attained.

Avoid starting the motorcycle with the stand down.

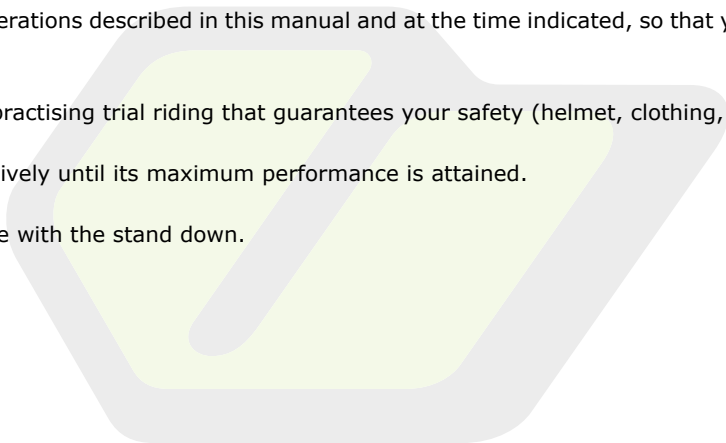

Certain measures need to be taken to ensure the proper maintenance of the motorbike in the event of the machine undergoing long periods of inactivity:

- Disconnect the battery if the inactivity lasts longer than 10 days.
- Clean the bike completely before storing it.
- Reduce the pressure in the tyres.
- Protect the bike with a cover to prevent dust and dirt from settling.

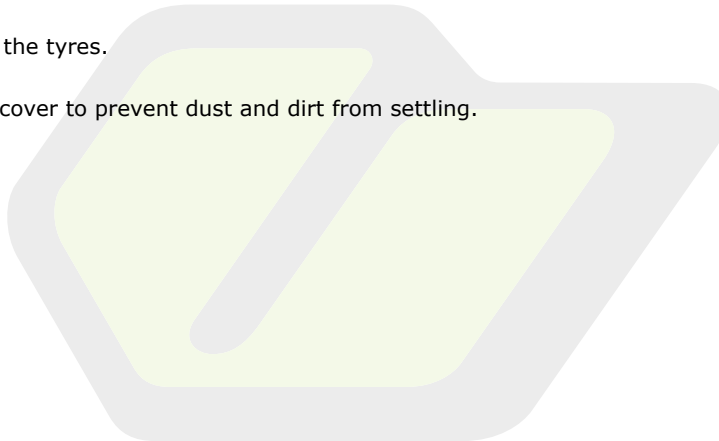



CHASSIS IDENTIFICATION

Note in the following box the chassis number that you will find on your motorbike's steering down-tube as shown in the picture.

You will need this number to order spare parts or for official procedures.

CHASSIS NUMBER



ENGINE IDENTIFICATION

Note in the following box the engine number that you will find at the bottom of your motorbike, as shown in the picture.

You will need this number to order spare parts or for official procedures.

ENGINE NUMBER



RIGHT-HAND SIDE VIEW

Identify the following elements on your motorbike in order to familiarise yourself with it before starting up.



1 Exhaust

2 On/stop button

3 Radiator cap

4 Kick-start lever

5 Rear brake pedal

6 Rear brake disk



LEFT-HAND SIDE VIEW

Identify the following elements on your motorbike in order to familiarise yourself with it before starting up.



7 Front suspension

9 Rear sprocket

11 Front brake disk

8 Silencer

10 Gear-change lever

12 Petrol tank filler cap



FUEL TANK

Access to the petrol tank is in the middle of the motorbike.

Turn the ring (A) to the left and pull the cover back to access the filler cap.

Always use 95 octane or 98 octane petrol with a mixture of 0.75% 2-stroke oil.

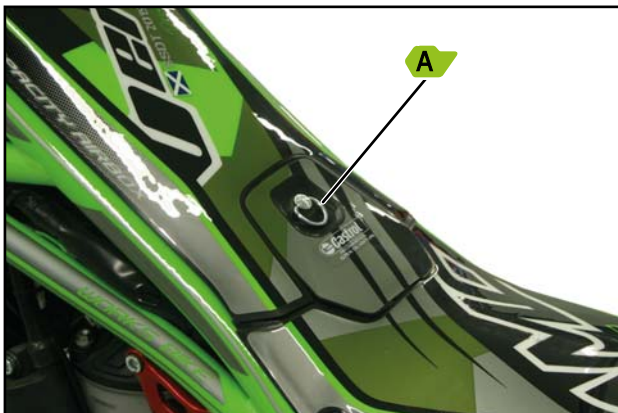

Remove any petrol remains that may have come into contact with the machine's components so that they are not damaged.



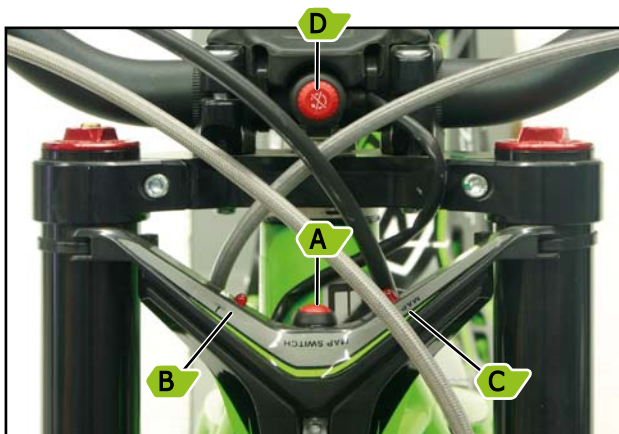

- A – Map selector
- B – Temperature indicator light
- C – Map indicator light
- D - Ignition/Stop button

SELECTING MAPS

To start up the machine, press the stop button (D) to turn on the ECU. The LED MAP will light up and you will have 15 seconds to start the motorbike. If not, the ECU will switch off and you will have to repeat the process.

To choose the motorbike map (C) there are 4 different options available:

Map 1: The standard map used by the motorcycle.
The LED will light up with a single flash.

Map 2: A slightly richer map than the standard one.
The LED will light up with a double flash.

Map 3: An even richer map.
The LED will light up with a triple flash.

Map 4: A lean map recommended dry for use in the mountains. The LED will light up with 4 flashes.

You should note that when you turn off or stall the bike, on starting it up again, the map will always return to the standard version (Map 1).

The temperature LED (B) indicates when the motorcycle is overheating.

To stop the machine, press the stop button (D).





KICK-START LEVER

The motorcycle is started using the kick-start lever on the right-hand side of the machine.

Turn the lever out to allow your foot to be positioned, then kick down smartly.

Remove your foot when the engine starts to avoid damage and allow the pedal to return to its fold-away position.



Use the kick-start lever with your foot **ONLY**.



MAGNETIC KILL SWITCH DISCONNECTION

If your bike has a magnetic kill switch system connected, after having stopped the bike, the magnet needs to be returned to its original position to prevent the bike's battery from draining.

Without the magnet, the bike's ignition will stay on after 15 seconds, causing the battery to drain.



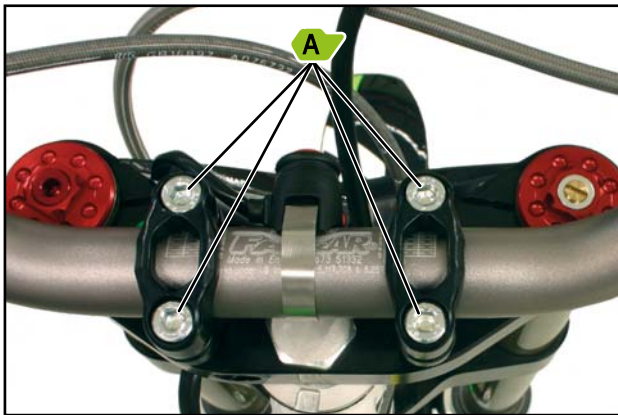

HANDLEBAR

Adjusting **the inclination of the handlebar** so that is best suits your style of riding.

- Loosen the 4 bolts (A).
- Place the handlebar in the position that is most suitable for you.
- Re-tighten the 4 bolts (A).



Ensure the handlebar are centred before tightening the bolts.



Tighten the four bolts cross-wise and equally.
We recommend you adjust the controls on the handlebars.

Adjusting **the handlebar distance**.

The handlebar clamps have 4 different positions to adapt according to your requirements.

Inverting the position of the handlebar clamps can either bring the handlebar closer or move them further away.

Modifying the handlebar clamps anchor to the plate with two positions available allows you to move the handlebar closer or further away.



Make sure that the bolts are tightened to the torque shown in the tightening table to avoid any possible accidents.



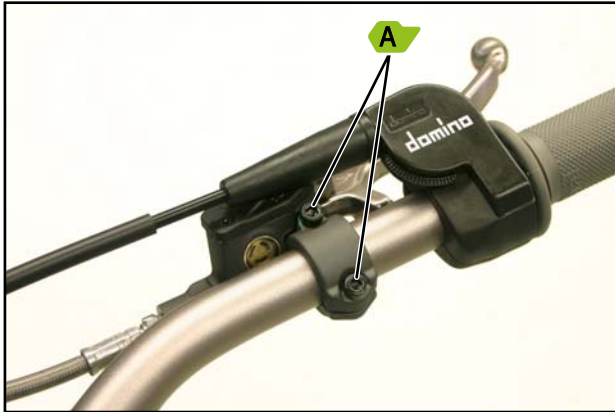

FRONT BRAKE LEVER

Adjusting the position of the front brake lever so that it best suits your style of riding.

- Loosen the 2 bolts (A).
- Turn the lever to the position that suits you best.
- Re-tighten the 2 bolts (A).



Tighten the two bolts equally.

CLUTCH LEVER

Adjusting the position of the clutch lever so that it best suits your style of riding.

- Loosen the 2 bolts (A).
- Turn the lever to the position that suits you best.
- Re-tighten the 2 bolts (A).



Tighten the two bolts equally.

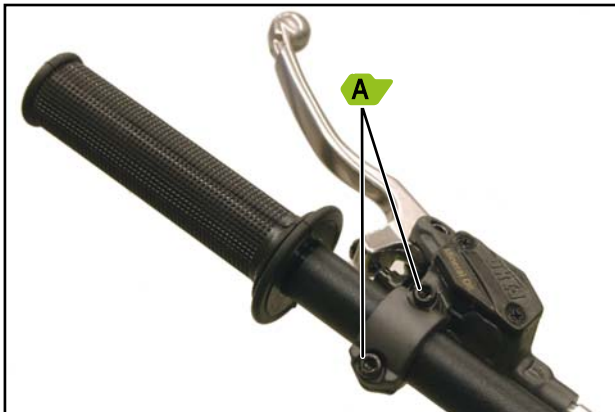

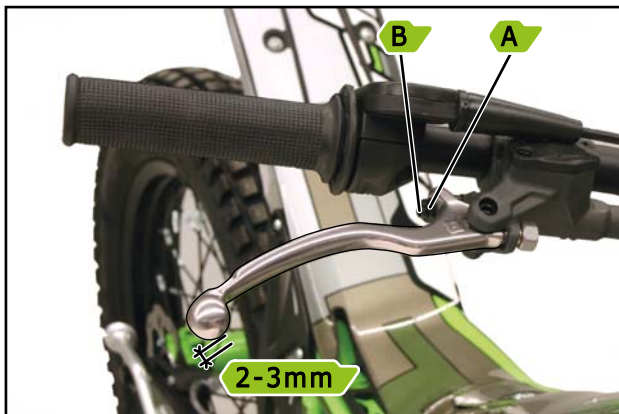

FRONT BRAKE LEVER FREE PLAY

The front brake lever should have the minimum play without activating. Carry out the following steps to maintain this tolerance:

- Loosen the securing nut (A).
- Adjust the free play with the inner threaded shaft (B).
- Secure the position with the nut (A).



The tolerance should be between 2 and 3mm.

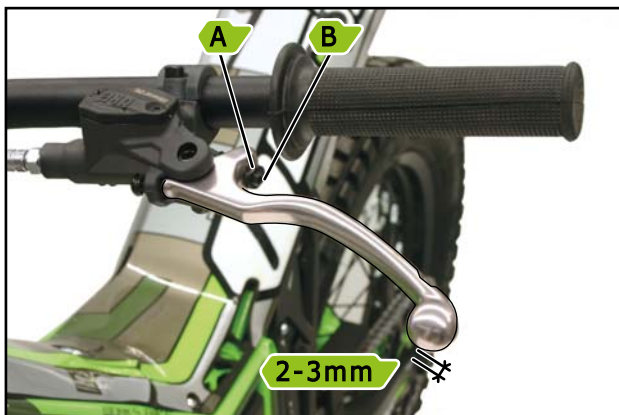

FRONT CLUTCH LEVER FREE PLAY

The clutch lever should have the minimum play without activating. Carry out the following steps to maintain this tolerance:

- Loosen the securing nut (A).
- Adjust the free play with the inner threaded shaft (B).
- Secure the position with the nut (A).



The tolerance should be between 2 and 3mm.





FRONT BRAKE FLUID

The front brake fluid reservoir incorporates a spy-hole (A) to enable the fluid level to be checked. Fluid should always be visible in the spy-hole to ensure an optimum level of the front brake fluid.

Type of brake fluid: DOT 4



Remove any remains of fluid that may have come into contact with the machine's components so that they are not damaged.



For a complete replacement, consult an official Vertigo dealer.

CLUTCH LEVER FLUID

To check the level of the fluid for the lever, remove the reservoir cover and bellows. Check the fluid level is up to the half-way mark in the reservoir, and top up if it is below this level.

Type of clutch fluid: Mineral oil.



Remove any remains of fluid that may have come into contact with the machine's components so that they are not damaged.



For a complete replacement, consult an official Vertigo dealer.





REAR BRAKE FLUID

The rear brake fluid reservoir incorporates a spy-hole (A) to enable the fluid level to be checked.

Fluid should always be visible in the spy-hole to ensure an optimum level of the rear brake fluid.

Type of brake fluid: DOT 4



For a complete replacement, consult an official Vertigo dealer.

3 CLUTCH POSITIONS

In order to extend the useful life of the clutch, there are 3 different positions for the feel of the clutch, if wear causes slipping, the green ring (A) can be moved to Position 2 or 3 to improve the responsiveness of the clutch.

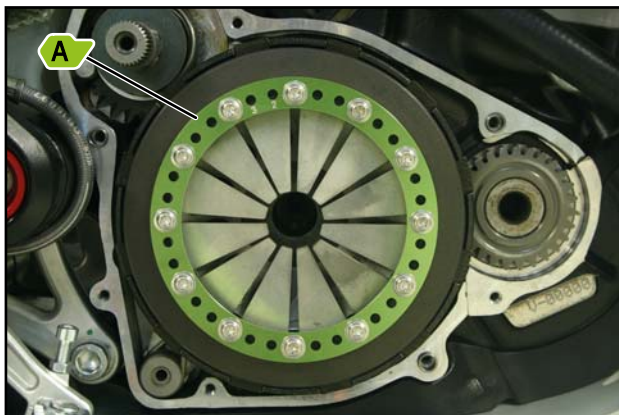

For this operation, consult an official Vertigo dealer.



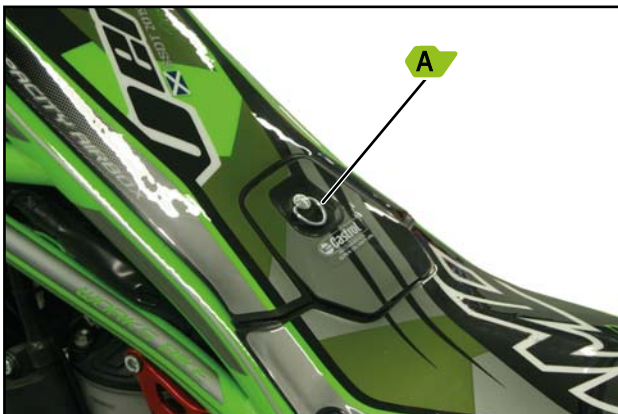

AIR FILTER

To access the air filter, remove the filter cover.

Firstly, open the cover to access the fuel tank by turning the ring (A).

To clean properly, use soapy water and lubricate the filter with a special oil for air filters.



If the machine is used in very dusty areas, clean more frequently than the times recommended in the maintenance table.





SPARK PLUG

To access the spark plug, first remove the air filter (see previous section).

Then remove the bolt (A) located at the top through the hole in the filter case.

Pull upwards to remove the filter case (B). Remove the spark plug cap.

With a 19 sparkplug spanner, remove the spark plug and renew it if necessary.

Proceed in reverse order for re-fitting.



Before removing the spark plug, ensure the engine has cooled down.





Inspect the condition of the spark plug frequently to check if the engine combustion is correct.

Type of spark plug: BPMR6A

Also check the gap between the electrode and the arc, which should be 0.7 mm.



RADIATOR GRILL MAINTENANCE

To prevent it from overheating, the bike is equipped with a temperature sensor and an LED that indicates when the engine temperature exceeds the operating limit. The machine should be stopped and a check performed to ensure that the grille and radiator are free from dirt and mud, and that there is no loss of coolant. After cleaning it wait a few minutes then start up the motorcycle and check that the LED does not light up.



If the problem persists, contact our network of dealerships in order to repair it.





COOLANT

Remove the coolant filler bolt (A) in order to check that the level is appropriate.

Total capacity: 600 ml

Type of coolant: Castrol Radicool SF Premix.



Before removing the coolant filler bolt, ensure that the coolant has cooled down.

Use special -37° coolant at all times.



For a complete replacement, consult an official Vertigo dealer.



BATTERY

The 8.4 v battery is located inside the air filter case, at the top.

To access it, the air filter cover needs to be removed (see section).

The battery used in this motorcycle is rechargeable.





FRONT BRAKE PADS

The front brake caliper make it possible to view the condition of the brake pads.

Remember that to ensure proper braking, the pads must not be below 2 mm.

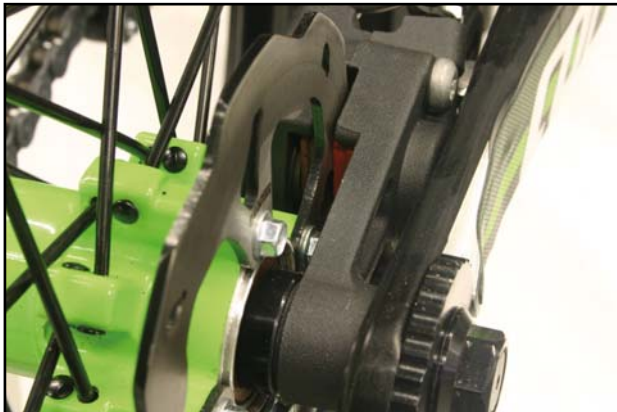

REAR BRAKE PADS

The rear brake caliper make it possible to view the condition of the brake pads.

Remember that to ensure proper braking, the pads must not be below 2 mm.



FRONT SUSPENSION

The front suspension is made up of two suspension bars. Each of them is adjustable, thereby allowing the hardness and the speed of absorption and return to be regulated.



LEFT-HAND BAR (A)

The preload for the shock absorber can be adjusted using the top bolt.

Turn to the left to soften or to the right to harden the suspension.

RIGHT-HAND BAR (B)

The speed of absorption and return of the suspension can be adjusted using the top bolt.

Turn to the left to slow down or to the right to speed up the absorption or return of the suspension.



SHOCK ABSORBER

The rear shock absorber allows three different types of adjustment.

- **Adjusting the preload** on the shock absorber spring (A).

The shock absorber incorporates two rings that make it possible to change the shock absorber spring preload: one to determine the position and the other to set it.

- **Adjusting high and low speed compression.**

Access to the adjustment wheel is at the bottom of the swinging arm at the front.

The purple knob (B) on the damper is your compression adjuster. Turn it clockwise for more compression damping or counter clockwise for less compression damping.

The maximum number of clicks on this adjuster is 24.



The shock absorber is adjusted for a weight of between 70 and 80 kgs.





- Rebound adjustment (C)

The rebound adjustment has 50 “clicks”, is located at the top of the shock absorber and can be adjusted using a flat-head screwdriver. Turning the adjustment screw clockwise will provide more stability but with a loss of traction, so if the aim is to gain traction, the screw should be turned anticlockwise.



Handle the adjustment screws carefully. If the limit of adjustment is exceeded, severe damage can be caused to the shock absorber.

Remember to make a note of the number of clicks if the adjustment is changed, so that the standard adjustment can be returned to if necessary.



CHAIN

The drive chain requires continuous attention to ensure its duration and optimal condition.

The image shows the checkpoint for a correct tension, which should be a distance of about 2 cm.



The tension should be adjusted by loosening the axle nut and turning the wheel axle with an 8 Allen key until the desired tension is achieved.

If the chain is renewed, remember that the fastening clip must be placed in the opposite direction to the travel, as indicated in the photo (B).

With a new chain, the eccentric chain tensors (A) should be placed at Point 9.

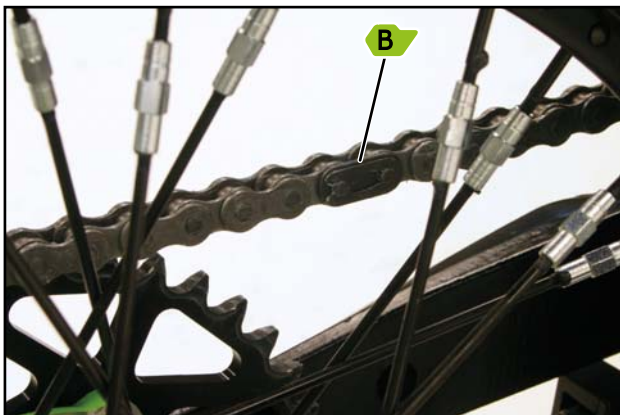



TYRES

Keep the tyres in good condition and with adequate pressure in order to ensure a good grip and prevent possible falls.

Front tyre:

Size: 1.60 x 21"

Pressure: 0,4 bar

Rear tyre:

Size: 2.15 x 18"

Pressure: 0.3 bar



ENGINE OIL

The right crankcase cover incorporates a spy-hole to aid in checking the engine oil level.

The filler plug can be found at the top.



Total capacity: 375 ml

Type of oil: CASTROL TRANSMAX Z



For a complete renewal, consult an official Vertigo dealer.



LUBRICATION

Keep the areas shown below clean and lubricated:



Throttle cable



Kick-start lever



Footrests



Rear brake pedal



Shift lever



Chain



TORQUE TIGHTNESS SETTINGS



COMPONENT	TIGHTENING
Swingarm semiaxis	50 Nm
Suspension triangle	50 Nm
Rear wheel axle	40 Nm
Rear brake disk	25 Nm
Front wheel axle	50 Nm
Rear sprocket	35 Nm
Handlebar clamp	25 Nm
Fork clamps	12 Nm
Handlebar clamp nut	25 Nm
Upper fork clamp to steering axle	10 Nm
Handlebar clamp stud	27 Nm
Front brake caliper	17 Nm
Front mudguard bracket	12 Nm
Frame	40 Nm

COMPONENT	TIGHTENING
Footrests	25 Nm
Exhaust	12 Nm
Front sub-chassis	25 Nm
Skid plate	22 Nm
Footrest bracket	25 Nm
Levers	5 Nm



MAINTENANCE TABLE



ELEMENT	CLEANING	CHECK	ADJUSTMENT	GREASING	RENEWAL	OBSERVATIONS
Tyres	-	periodical	-	-	due to wear	Check for damage and inflation pressures
Front/rear wheel	periodical	periodical	-	-	due to damage	Check the tension of the spokes
Braking system	periodical	periodical	if necessary	-	due to damage	
Brake pad wear	periodical	periodical	-	-	due to wear	
Brake fluid	-	periodical	-	-	1 year	
Suspension forks	-	periodical	if necessary	-	due to damage	
Suspension fork fluid	-	periodical	-	-	6 months	
Rear shock absorber	-	periodical	if necessary	-	due to damage	
Rear suspension	-	periodical	-	every wash	due to damage	
Front and rear drive sprocket	periodical	periodical	-	every wash	due to damage	
Drive chain	periodical	periodical	if necessary	every wash	due to wear	
Chain guide and tensioner	-	periodical	-	-	due to wear	
Frame and sub-chassis	-	periodical	-	-	due to damage	
Steering bearing	-	-	-	-	due to wear	Check steering play



MAINTENANCE TABLE

ELEMENT	CLEANING	CHECK	ADJUSTMENT	GREASING	RENEWAL	OBSERVATIONS
Nuts and bolts and securing devices	-	periodical	-	-	due to damage	See manual for tightening torques
Clutch system	-	periodical	if necessary	-	due to wear	
Clutch fluid	-	periodical	-	-	1 year	
Transmission oil	-	periodical	-	-	6 months	
Cooling system	periodical	periodical	-	-	due to damage	Keep the radiator and grille mud-free
Coolant	-	periodical	-	-	1 year	
Cylinder – cylinder head	-	periodical	-	-	due to wear	
Piston	-	periodical	-	-	100 hours	60 hours in intensive competition use
Electrical connections	-	periodical	-	every wash	due to damage	Clean and grease connectors
Battery	-	periodical	-	-	due to wear	Recharge the battery after use
Throttle cable and throttle control	periodical	periodical	if necessary	every wash	due to damage	Keep the cable running freely and greased
Air filter	periodical	periodical	-	every wash	due to damage	Shorten period in extreme conditions
Spark plug	15 hours	periodical	-	-	due to wear	
Fuel circuit	-	periodical	-	-	due to damage	Check for leaks



APPROVAL

All materials used in the manufacture of this machine comply with the regulations established regarding official approval, including the specific parts that require identification of approval.

Below are listed the components required to be able to operate on the public highway and that your machine needs to be equipped with when attending the Technical Inspection of Vehicles ('MOT'):

- Catalysed exhaust manifold
- Horn
- Electrical wiring
- Rear-view mirrors
- Ignition lock
- Indicators
- Lighting system
- Reflectors
- Number plate holder
- Manufacturer's identification sticker
- Multifunction speedometer
- Speed sensor
- Protruding protectors
- Front brake cylinder sensor
- Rear brake cylinder sensor



IMPORTANT NOTICE:

This machine is supplied with a series of additional parts that make up the RACING KIT. This kit changes the established motorcycle performance and is NOT covered by the machine's official approval.



TECHNICAL DETAILS

DIMENSIONS

Seat height	680 mm
Total length	2,010 mm
Distance between axles	1,310 mm
Weight	69 kg

WHEELS

Front wheel	Tyre	1.60 x 21"
	Pressure	0.4 bar
Rear wheel (machined)	Tyre	2.15 x 18"
	Pressure	0.3 bar



CHASSIS

Type	Tubular CrMo + Aluminium sub-chassis	
Swinging arm	Double arm aluminium	
Front suspension	Tech Alu black	
	Adjustment	Adjustable compression, length and spring pre-load
	Travel	170 mm
Rear suspension	Single REIGER hydraulic shock absorber	
	Adjustment	Adjustable compression, length and spring pre-load
	Travel	170 mm

BRAKES

Front	Model	Braktek Hydraulic with 185 mm disk
	Caliper	4 pistons
Rear	Model	Braktek Hydraulic with 150 mm disk
	Caliper	2 pistons



CAPACITIES

Fuel	Type	Petrol
	Capacity	2.3 litres
	Mixture	0.75% 2-stroke oil
Coolant	Type	Castrol Radicool SF Premix
	Capacity	600 ml
Clutch fluid	Type	Mineral oil
Change oil	Type	CASTROL TRANSMAX Z
	Capacity	375 ml
Brake fluid	Type	DOT 4



ENGINE

Cubic capacity	300 cc	247 cc
Type	Single cylinder 2-stroke	Single cylinder 2-stroke
Cooling system	Water-cooled	Water-cooled
Diameter and run	79 x 60 mm	72.5 x 60 mm
Supply	Electrical power supply	Electrical power supply
Compression	8.7:1	8.8:1
Maximum declared power capacity	31 CV / 9200 rpm	25 CV / 9200 rpm
Maximum declared torque	4.9 kg·m / 4500 rpm	4.0 kg·m / 4500 rpm
Spark plug	Model	BPMR6A
	Tolerance	0.7 mm

TRANSMISSION

Clutch	Multi-disk wet clutch	Multi-disk wet clutch
Gear change	6 gears	6 gears
Secondary transmission	Chain (9/38z)	Chain (9/38z)



Félicitation pour votre achat !

Nous voudrions vous souhaiter la bienvenue chez Vertigo Motors et partager avec vous notre expérience et passion pour le trial, le design, la technique, l'innovation et la recherche.

Soucieux d'améliorer les motos trial pour leur faire atteindre le niveau supérieur.

Chez Vertigo, nous rêvons de créer la moto idéale pour pratiquer notre passion, sans distinctions entre les amateurs et les professionnels, une moto révolutionnaire pensée pour vous.

À partir de maintenant, vous faites parti de notre équipe, vous intégrant à la meilleure équipe technique, pilotes, passionnés de moteurs et des meilleurs professionnels de chaque spécialité.
Tous réunis par un dénominateur commun: **Passion et Expérience.**

En plus, chez Vertigo, nous vous offrons la possibilité de pratiquer le trial sur un terrain privé (**Noassar**), située à Camprodón dans le complexe hôtelier du Puig-Francó et dans lequel vous pouvez profiter de votre passion pour le trial. Pour plus d'information, visiter la page web: **www.puigfranco.es**

Avec ce manuel, nous vous fournissons les données, les travaux d'entretien et les réglages basiques que vous pourrez réaliser vous-même sur votre nouvelle Vertigo. Également, chez votre Concessionnaire Officiel Vertigo Motors, vous trouverez une équipe d'experts qui pourra vous conseiller dans tous les domaines en rapport avec votre moto ou ses compléments.

Nous vous invitons à faire partie de notre histoire et de notre succès.



Présentation et remerciements	75
Légende utilisée	78
Conseils de sécurité	79
Longue période d'immobilité de la moto	80
Identification de la moto	81
Identification des éléments de la moto	82-83
Éléments basiques pour le démarrage de la moto	84-86
Entretien	
Guidon	87
Levier de frein avant	88
Levier d'embrayage	88
Jeu du levier de frein avant	89
Jeu du levier d'embrayage	89
Liquide de frein avant	90
Liquide de levier d'embrayage	90
Liquide de frein arrière	91
3 positions d'embrayage	91
Filtre à air	92
Bougies	93-94
Entretien de la grille du radiateur	94
Liquide de refroidissement	95
Batterie	95
Plaquettes de frein avant	96
Plaquettes de frein arrière	96
Fourche	97
Amortisseur	98-99
Chaîne	100
Pneus	101

Huile moteur	101
Lubrification	102
Couples de serrage	103
Tableau d'entretien	104-105
Homologation	106
Données techniques	107-110



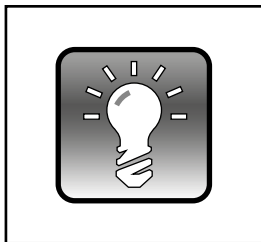

CONSEIL

Avec ce symbole, nous vous donnons des indications afin de vous faciliter les opérations d'entretien que vous voulez réaliser.

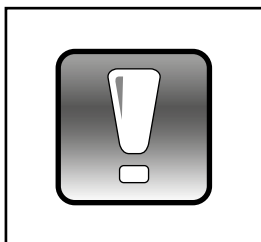

AVERTISSEMENT

Avec ce symbole, nous voulons vous avertir des possibles situations de danger qui pourrait se présenter lors de certaines opérations décrites dans ce manuel.

Pour chaque opération d'entretien que vous réalisez, en plus des conseils et avertissements qui vous sont indiqués, veuillez toujours utiliser le sens commun pour ne pas mettre en danger votre intégrité physique ou celle des personnes qui vous aideront.



Avant d'utiliser cette moto, familiarisez-vous avec elle, situez et identifiez tous les éléments basiques de conduite.

Lisez attentivement tous et chacun des points de ce manuel.

Cette moto a été créée pour un usage trial uniquement et ne peut donc pas supporter un second passager.

Réalisez les opérations d'entretien décrites dans ce manuel et seulement au moment indiqué pour que votre moto reste en bon état et cela le plus longtemps possible.

Utilisez un équipement adapté pour la pratique du Trial qui garantit votre sécurité (casque, vêtements adaptés, protections, etc...).

Utilisez la moto de façon progressive jusqu'à atteindre son rendement maximum.

Évitez de démarrer la moto avec la béquille abaissée.

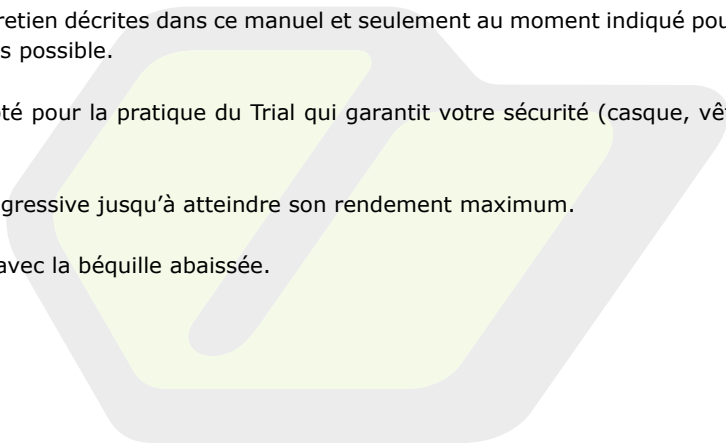

Il est nécessaire d'adopter certaines mesures pour garantir le bon entretien de la moto en cas de longue période d'immobilité du véhicule:

- Débrancher la batterie si la période d'immobilité dépasse les 10 jours.
- Procéder à un nettoyage complet de la moto avant son démarrage.
- Réduire la pression des pneus.
- Couvrir la moto avec une housse afin d'éviter la poussière et la saleté.

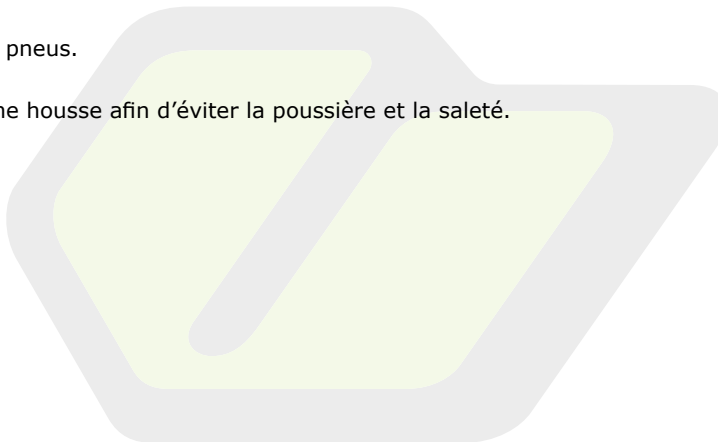



IDENTIFICATION DU CHÂSSIS

Notez dans le cadre ci-dessous le numéro de châssis qui se trouve sur la colonne de direction de votre moto (cf. photo à gauche). Vous aurez besoin de ce numéro pour la commande de pièces de rechange ou en cas de recours.

NUMÉRO DE CHÂSSIS



IDENTIFICATION DU MOTEUR

Notez dans le cadre ci-dessous le numéro de moteur qui se trouve sur la partie inférieure droite du moteur (cf. photo à gauche). Vous aurez besoin de ce numéro pour la commande de pièces de rechange ou en cas de recours.

NUMÉRO DU MOTEUR



VUE LATÉRALE DROITE

Identifiez les éléments suivants de votre moto afin de vous familiariser avec elle avant de la démarrer.



1 Pot d'échappement

2 Bouton démarrage/arrêt

3 Bouchon du radiateur

4 Levier de kick

5 Pédale de frein arrière

6 Disque de frein arrière



IDENTIFICATION DES ÉLÉMENTS DE LA MOTO

VUE LATÉRALE GAUCHE

Identifiez les éléments suivants de votre moto afin de vous familiariser avec elle avant de la démarrer.



7 Suspension avant

8 Silencieux

9 Couronne

10 Sélecteur de vitesse

11 Disque de frein avant

12 Réservoir



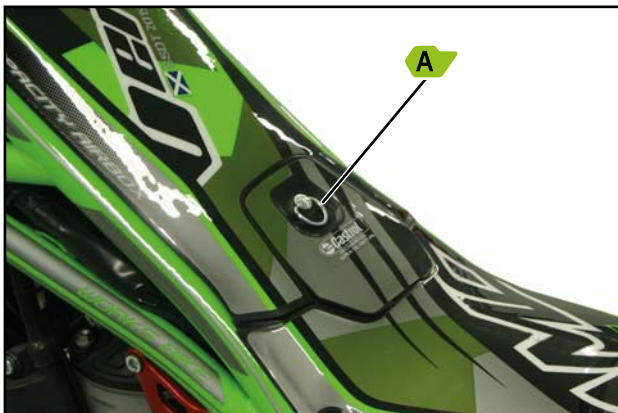

RÉSERVOIR

L'accès au réservoir se trouve au centre de la moto.

Tournez l'anneau (A) vers la gauche et tirez le cache vers l'arrière afin d'accéder au bouchon.

Toujours utiliser essence sans plomb 95 ou 98 avec un mélange d'huile 2T de 0,75%.



Enlevez tout reste d'essence qui a été en contact avec les composants de la moto pour éviter qu'ils soient endommagés.



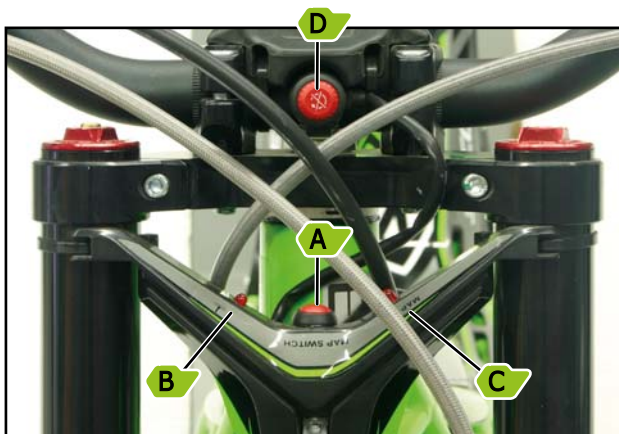

- A – Sélecteur de mode
- B – Témoin de température
- C – Témoin de mode
- D - Contact / Bouton d'arrêt

SELECTION DU MODE

Pour démarrer la moto vous devez appuyer sur le bouton d'arrêt (D) pour allumer la ECU (Unité de Commande Electronique), la LED MAP s'allumera et vous aurez 15 secondes pour démarrer la moto, sinon la ECU s'arrêtera et vous devrez répéter le processus.

Pour choisir le mode du moteur (C), vous avez 4 options différentes:

Mode 1: C'est la courbe standard de la moto.
La LED s'illuminera avec une fréquence d'un clignotement.

Mode 2: Mode un peu plus riche que le standard.
La LED s'illuminera avec une fréquence de deux clignotements.

Mode 3: Mode encore plus riche.
La LED s'illuminera avec une fréquence de trois clignotements.

Mode 4: Courbe sèche complètement recommandé pour utilisation en hauteur.
La LED s'illuminera avec une fréquence de quatre clignotements.

Vous devez prendre en compte que quand vous arrêtez la moto ou qu'elle cale, lorsque vous allez la redémarrer, le mode reviendra toujours au mode standard (Mode 1).

La LED de température (B) nous informe lorsqu'il y a une surchauffe de la moto.

Pour arrêter le moteur, maintenez le bouton d'arrêt (D).





LEVIER DE KICK

Le stationnement de la moto se fait par le levier de kick située à la droite de la moto.

Tournez le levier de kick pour pouvoir poser le pied et pousser vers le bas énergiquement.

Retirez le pied quand le moteur est en marche pour ne pas l'endommager et remettez le levier de kick dans sa position initiale.



Actionner le levier de kick SEULEMENT avec le pied.

DISPOSITIF PILOT TOMBÉ

Si vous ajoutez un dispositif pilot tombé, il est nécessaire une fois la moto arrêtée, de remettre l'aimant à sa place pour éviter la décharge de la batterie de la moto.

Sans l'aimant, le contact de la moto sera toujours allumé pendant 15 secondes, ce qui provoque la décharge de la batterie.



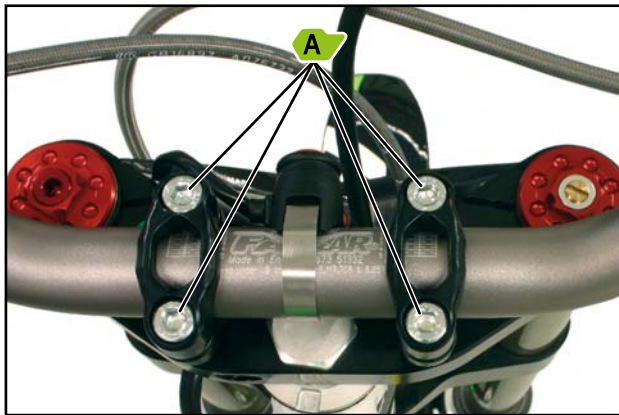

GUIDON

Ajustez l'**inclinaison du guidon** pour qu'il s'adapte au mieux à votre style de conduite:

- Desserrez les 4 vis (A).
- Positionnez le guidon dans la position désirée.
- Revissez les 4 vis (A).



Assurez-vous que le guidon soit centré avant de resserrer les vis.



Mettez les quatre vis en forme de croix et de la même manière. Nous vous recommandons d'ajuster les commandes du guidon.



Ajustez la **distance du guidon**.

Il y a 4 différentes positions pour ajuster le guidon selon votre préférence.

En changeant la position des pontets ajustables, vous pouvez rapprocher ou éloigner le guidon.



En modifiant l'attachement du pontet ajustable à la fourche avec les deux positions disponibles, vous pouvez rapprocher ou éloigner le guidon.



Vous devez vous assurer du serrage des vis selon les couples de serrage (cf. tableau couples de serrage) pour éviter tout accident possible.



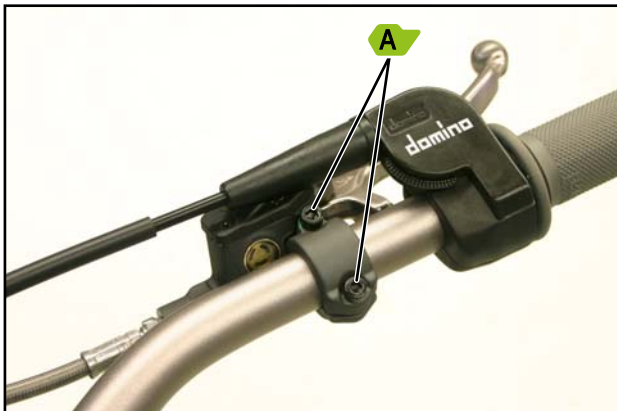

LEVIER DE FREIN AVANT

Ajustez la position du levier pour qu'il s'adapte au mieux à votre style de conduite:

- Desserrez les 2 vis (A).
- Positionnez le levier dans la position désirée.
- Revissez les 2 vis (A).



Serrez les deux vis de la même manière.

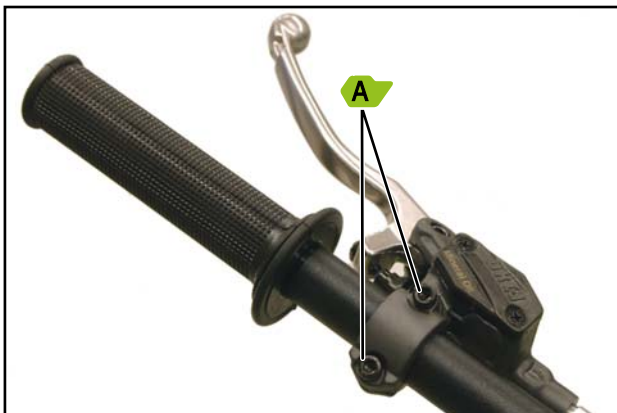

LEVIER D'EMBRAYAGE

Ajustez la position du levier d'embrayage pour qu'il s'adapte au mieux à votre style de conduite.

- Desserrez les 2 vis (A).
- Positionnez le levier dans la position désirée.
- Revissez les 2 vis (A).



Serrez les deux vis de la même manière.



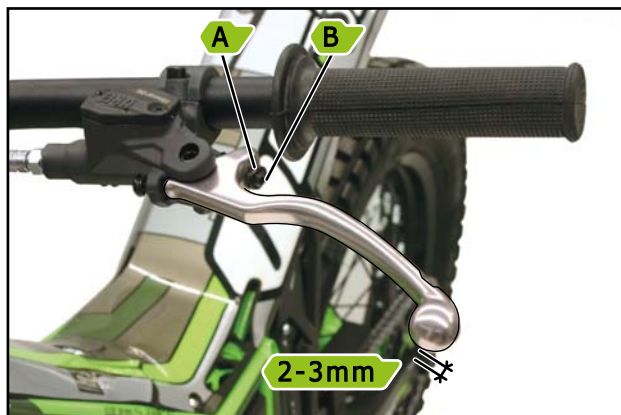

JEU DU LEVIER DE FREIN AVANT

Le levier de frein avant doit avoir un petit jeu sans bouger. Réalisez les étapes suivantes pour maintenir ce jeu.

- Desserrez l'écrou de fixation (A).
- Ajustez le jeu libre avec l'axe de filetage intérieur (B).
- Fixez la position avec l'écrou (A).



Le jeu doit être entre 2 et 3 mm.

JEU DU LEVIER D'EMBRAYAGE

Le levier d'embrayage doit avoir un petit jeu sans bouger. Réalisez les étapes suivantes pour maintenir ce jeu.

- Desserrez l'écrou de fixation (A).
- Ajustez le jeu libre avec l'axe de filetage intérieur (B).
- Fixez la position avec l'écrou (A).



Le jeu doit être entre 2 et 3 mm.



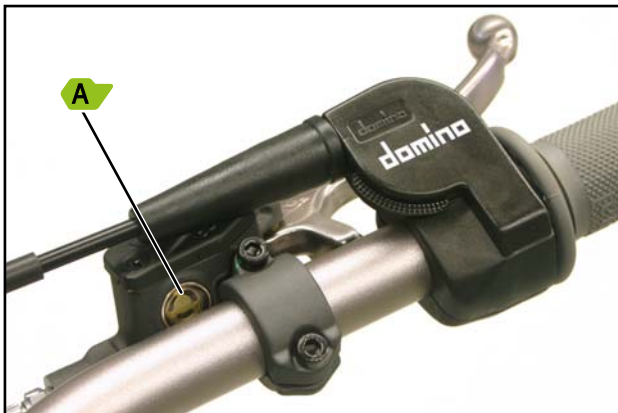

LIQUIDE DE FREIN AVANT

Le réservoir de liquide de frein avant a une jauge (A) pour pouvoir vérifier le niveau.

Le liquide doit toujours être visible dans la jauge pour garantir un niveau optimal de liquide de frein avant.

Type de liquide de frein: DOT 4



Enlevez tout reste de liquide qui a été en contact avec les composants de la moto pour éviter qu'ils soient endommagés.



Pour un changement total, rendez-vous chez votre concessionnaire officiel Vertigo.

LIQUIDE DE LEVIER D'EMBRAYAGE

Pour vérifier le niveau de liquide du levier, il faut retirer le cache et le soufflet du réservoir.

Vérifiez le niveau d'huile est à la moitié et remplissez-le si le niveau est en dessous.

Type d'huile d'embrayage: Huile minérale.



Enlevez tout reste de liquide qui a été en contact avec les composants de la moto pour éviter qu'ils soient endommagés.



Pour un changement total, rendez-vous chez votre concessionnaire officiel Vertigo.





LIQUIDE DE FREIN ARRIÈRE

Le réservoir de liquide de frein arrière a une jauge de niveau d'huile (A) pour pouvoir vérifier le niveau.

Le liquide doit toujours être visible dans le jauge de niveau pour garantir un niveau optimal de liquide de frein avant.

Type de liquide de frein: DOT 4



Pour un changement total, rendez-vous chez votre concessionnaire officiel Vertigo.

3 POSITIONS D'EMBRAYAGE

Afin d'allonger la durée de vie de l'embrayage, il y a 3 positions différentes pour la souplesse de l'embrayage, si l'usure des disques provoque des glissements, vous pouvez bouger l'anneau vert (A) sur la position 2 ou 3 pour améliorer la réactivité de l'embrayage

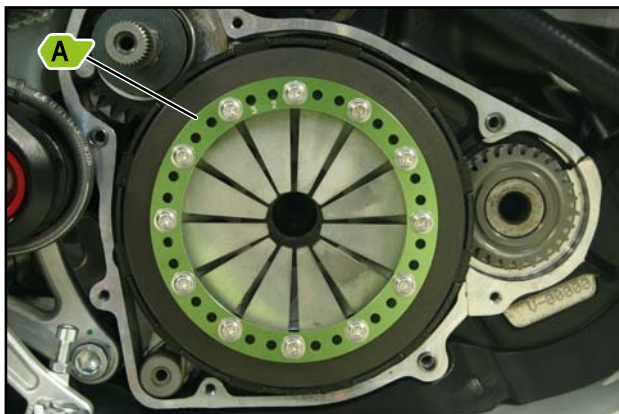

Pour un changement total, rendez-vous chez votre concessionnaire officiel Vertigo.



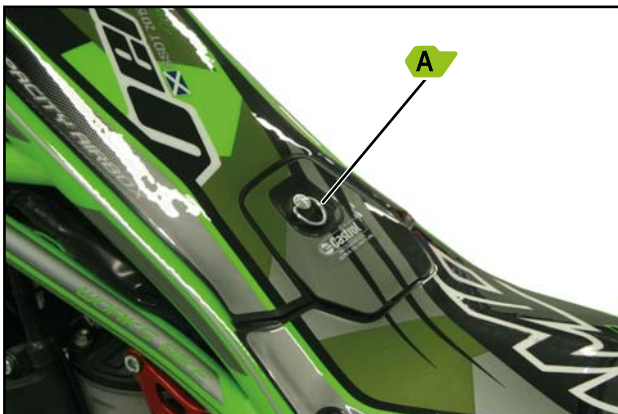

FILTRE À AIR

Pour accéder au filtre à air, vous devez retirer le cache du filtre.

Premièrement, vous devez ouvrir le cache d'accès au réservoir d'essence en tournant l'anneau (A).

Pour un bon nettoyage, utilisez de l'eau avec du produit nettoyant et graissez le filtre avec de l'huile spéciale pour filtre à air.



Si vous utilisez la moto dans des zones très poussiéreuses, raccourcir le temps de nettoyage recommandé dans le tableau d'entretien.





BOUGIES

Pour accéder à la bougie, retirez premièrement le filtre à air (voir paragraphe précédent).

Ensuite, retirez la vis (A) situé dans la partie supérieure, à travers l'orifice du compartiment du filtre.

Tirez le compartiment du filtre vers le bas (B). Retirez l'électrode de la bougie.

Avec une clé à bougies de 19, démontez la bougie et la changer si nécessaire.

Refaire ces étapes dans le sens inverse pour le montage.



Avant de retirer la bougie, assurez-vous que le moteur soit froid.





Vérifiez souvent l'état de la bougie pour savoir si le moteur fait correctement la combustion.

Type de bougie: BPMR6A

Vérifiez également que la distance entre l'électrode et l'arc doit être de 0,7 mm.



ENTRETIEN DE LA GRILLE DU RADIATEUR

Pour éviter une surchauffe de la moto, elle est équipée d'un capteur de température et une LED indique quand la température du moteur dépasse la limite de fonctionnement. Vous devrez arrêter la moto et vérifier qu'il n'y a pas de boue ou de saleté sur la grille et le radiateur mais aussi vérifier qu'il n'y a pas de perte de liquide refroidissant. Procédez au nettoyage et après quelques minutes, redémarrer la moto et vérifier que la LED ne s'allume pas.



Si le problème persiste, rendez-vous chez un concessionnaire de notre réseau pour la réparation de la moto.





LIQUIDE DE REFROIDISSEMENT

Retirez la vis (A) du réservoir de liquide refroidissement pour vérifier que son niveau soit correct.

Capacité totale: 600 ml

Type de liquide refroidissement: Castrol Radicool SF Premix.



Avant de retirer la vis du réservoir, assurez-vous que le liquide refroidissant soit froid.
Toujours utiliser le liquide refroidissement spécial -37°C.



Pour un changement total, Rendez-vous chez votre concessionnaire officiel Vertigo.



BATTERIE

La batterie de 8.4V se trouve dans le compartiment du filtre à air, dans la partie supérieur.

Pour y accéder, il suffit de retirer le cache du filtre à air (voir paragraphe « filtre à air »).

La batterie utilisée par cette moto est rechargeable.





PLAQUETTES DE FREIN AVANT

L'étrier de frein avant permet une visualisation de l'état des plaquettes de frein.

Souvenez-vous que pour garantir un freinage correct, les plaquettes de frein ne doivent être en dessous des 2mm.

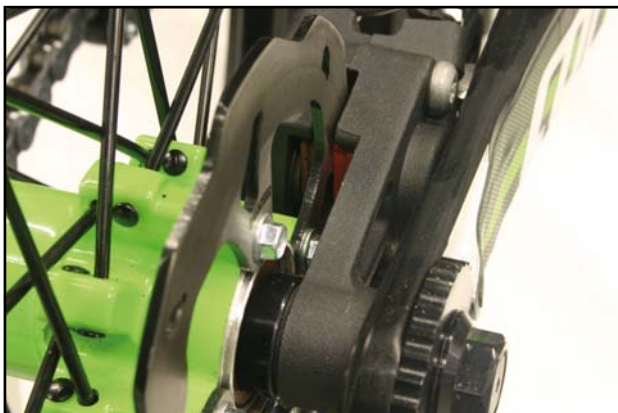

PLAQUETTES DE FREIN ARRIÈRE

L'étrier de frein arrière permet une visualisation de l'état des plaquettes de frein.

Souvenez-vous que pour garantir un freinage correct, les plaquettes de frein ne doivent être en dessous des 2mm.



FOURCHE

La fourche avant est composée de deux barres de suspension. Chacune est réglable, ce qui permet de régler la dureté comme la vitesse d'absorption et le retour.



BARRE DE GAUCHE (A)

Avec la vis supérieure, vous pouvez régler la précharge de l'amortisseur.

Tournez-le vers la gauche pour adoucir ou vers la droite pour durcir la suspension.

BARRE DE DROITE (B)

Avec la vis supérieure, vous pouvez modifier la vitesse d'absorption et de retour de la suspension.

Tournez vers la gauche pour ralentir ou vers la droite pour accélérer l'absorption ou le retour de la suspension.





AMORTISSEUR

L'amortisseur arrière a trois réglages différents.

- **Réglage de la précharge** du ressort de l'amortisseur (A).

L'amortisseur est composé de deux écrous qui permettent de modifier la précharge du ressort de l'amortisseur. Un pour choisir la position et l'autre pour la maintenir.

- **Réglage de la compression.**

L'écrou de réglage se situe sur la partie inférieure avant du bras.

Le bouton violet (B) sur l'amortisseur est le réglage de la compression. Tourner dans le sens horaire pour plus d'amortissement en compression ou antihoraire pour moins l'amortissement en compression.

Le nombre maximal de clics sur ce réglage est 24.



L'amortisseur est réglé pour un poids de 70 à 80 kg.





- Réglage du rebond (C)

Le réglage du rebond possède 50 crans et se trouve sur la partie supérieure de l'amortisseur et est réglable grâce à un tournevis plat. En tournant l'écrou de réglage dans le sens des aiguilles, vous gagnerez en stabilité mais perdrez en traction. Si vous voulez gagner en traction, vous devrez tourner l'écrou dans le sens inverse des aiguilles.



Manipulez les écrous de réglage avec délicatesse, si vous dépassez la limite de réglage, cela peut endommager l'amortisseur. Toujours prendre note du nombre de cran passé, si vous modifiez les réglages afin de pouvoir retrouver le réglage standard, si nécessaire.



CHAÎNE

La chaîne de transmission requière une attention continue pour garantir sa durée et un état optimal.

Dans les images suivantes, nous vous indiquons les points de vérification. Pour une tension correcte de la chaîne, il doit y avoir un espace d'environ 2 cm.



Le réglage de la tension doit se faire en desserrant l'écrou de l'axe et en faisant tourner l'axe de la roue avec une clé Allen de 8 jusqu'à obtenir la tension souhaitée.

Si vous changez la chaîne, rappelez-vous que le maillon de liaison doit être mis dans le sens contraire, comme indiqué ci-contre (B).

Avec une chaîne neuve, les excentriques de tendeur de chaîne (A) doivent être mis au point 9.

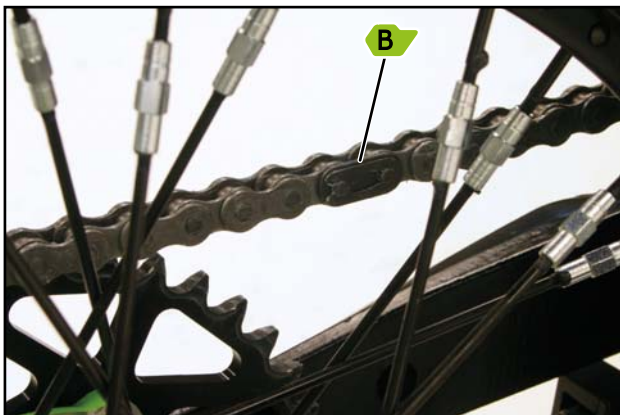



PNEUS

Garder vos pneus en bon état et avec la bonne pression pour garantir une bonne adhérence et éviter les chutes.

Pneu avant:

Dimension: 1,60 x 21"

Pression: 0,4 bars

Pneu arrière:

Dimension: 2,15 x 18"

Pression: 0,3 bars



HUILE MOTEUR

Le cache du carter droit est composé d'une jauge pour faciliter la vérification du niveau d'huile moteur.

Vous trouverez le bouchon du réservoir sur la partie supérieure.



Capacité totale: 375 ml

Type d'huile: CASTROL TRANSMAX Z



Pour un changement total, rendez-vous chez votre concessionnaire officiel Vertigo



LUBRIFICATION

Maintenir propre et lubrifié les pièces des photos suivantes:



Câble d'accélérateur



Levier de kick



Repose-pieds



Pédale de frein arrière



Sélecteur de vitesse



Chaîne



COUPLES DE SERRAGE

COMPOSANT	SERRAGE
Demi-axe bras oscillant	50 Nm
Triangle de suspension	50 Nm
Axe roue arrière	40 Nm
Disque de frein arrière	25 Nm
Axe roue avant	50 Nm
Couronne arrière	35 Nm
Pontets guidon	25 Nm
Fourches de suspension	12 Nm
Écrou des pontets guidon	25 Nm
Fourche sup. a axe de direction	10 Nm
Pontets ajustables	27 Nm
Étrier de frein	17 Nm
Garde-boue avant	12 Nm
Cadre	40 Nm

COMPOSANT	SERRAGE
Repose-pieds	25 Nm
Pot d'échappement	12 Nm
Berceau avant	25 Nm
Sabot	22 Nm
Support repose-pieds	25 Nm
Leviers	5 Nm



ÉLÉMENT	NETTOYAGE	VÉRIFICATION	RÉGLAGE	GRAISSAGE	REPLACEMENT	OBSERVATIONS
Pneus	-	régulière	-	-	Si usure	Vérifier les dommages et la pression
Jante avant/arrière	régulière	régulière	-	-	Si endommagé	Vérifier la tension des rayons
Système de freinage	régulière	régulière	si nécessaire	-	Si endommagé	
Usure des plaquettes de frein	régulière	régulière	-	-	Si usure	
Liquide de frein	-	régulière	-	-	Après 1 an	
Fourche de suspension	-	régulière	si nécessaire	-	Si endommagé	
Huile fourche suspension	-	régulière	-	-	Après 6 mois	
Amortisseur arrière	-	régulière	si nécessaire	-	Si endommagé	
Suspension arrière	-	régulière	-	Après chaque lavage	Si endommagé	
Couronne et pignon de transmission	régulière	régulière	-	Après chaque lavage	Si endommagé	
Chaîne de transmission	régulière	régulière	si nécessaire	Après chaque lavage	Si usure	
Guide et tendeur de chaîne	-	régulière	-	-	Si usure	
Cadre et berceau	-	régulière	-	-	Si endommagé	
Roulement de la direction	-	-	-	-	Si usure	Vérifier le jeu de la direction



TABEAU D'ENTRETIEN

ÉLÉMENT	NETTOYAGE	VÉRIFICATION	RÉGLAGE	GRAISSAGE	REPLACEMENT	OBSERVATIONS
Vis et fixation	-	régulière	-	-	Si endommagé	Voir le manuel de couples de serrage
Système d'embrayage	-	régulière	si nécessaire	-	Si usure	
Liquide d'embrayage	-	régulière	-	-	Après 1 an	
Huile de transmission	-	régulière	-	-	Après 6 mois	
Système de refroidissement	régulière	régulière	-	-	Si endommagé	Vérifier qu'il n'y ait pas de boue sur la grille et le radiateur
Liquide refroidissement	-	régulière	-	-	Après 1 an	
Barillet - culasse	-	50 horas	-	-	Si usure	
Piston	-	50 horas	-	-	Après 100 heures	Après 60 heures, si usage intensif en compétition
Connection électrique	-	régulière	-	Après chaque lavage	Si endommagé	Nettoyer et graisser les connecteurs
Batterie	-	régulière	-	-	Si usure	Recharger la batterie après son usage
Cable et commande de gaz	régulière	régulière	si nécessaire	Après chaque lavage	Si endommagé	Garder les câbles libres et graissés
Filtre à air	régulière	régulière	-	Après chaque lavage	Si endommagé	Réduire le temps en conditions extrêmes
Bougie	15 heures	régulière	-	-	Si usure	
Circuit d'injection	-	régulière	-	-	Si endommagé	Vérifier les fuites



Tous les matériaux utilisés dans la fabrication de ce véhicule respectent la norme en vigueur par rapport à l'homologation, ce qui inclue les pièces spécifiques qui nécessitent une identification d'homologation.

Les composants obligatoires pour pouvoir circuler sur la voie publique ainsi que ceux qui doivent équiper votre véhicule afin de passer le Contrôle Technique sont les suivants:

- Collecteur d'échappement catalysé
- Avertisseur sonore
- Installation électrique
- Rétroviseurs
- Contacteur
- Clignotants
- Système d'éclairage
- Catadioptrés
- Support de plaques d'immatriculation
- Étiquette d'identification du fabricant
- Compteur kilométrique multifonction
- Capteur de vitesse
- Protection
- Capteur de pompe du frein avant
- Capteur de pompe du frein arrière



CONSEIL IMPORTANT:

Ce véhicule est livré avec une série de pièces supplémentaires qui compose le KIT RACING. Ce kit modifie les prestations établies de la moto et NE sont PAS couvert par l'homologation du véhicule.



DIMENSIONS

Hauteur siège	680 mm
Longitude totale	2.010 mm
Distance entre les axes	1.310 mm
Poids	69 kg

ROUES

Roue avant	Pneu	1,60 x 21"
	Pression	0,4 bars
Roue arrière (mécanisé)	Pneu	2,15 x 18"
	Pression	0,3 bars



CHASSIS

Type	Tubulaire CrMo + berceau en aluminium	
Bras Oscillant	Aluminium double bras	
Suspension avant	Tech Alu noir	
	Réglage	Ajustable en compression, extension et précharge du ressort
	Dimension	170 mm
Suspension arrière	Amortisseur simple hydraulique REIGER	
	Réglage	Ajustable en compression, extension et précharge du ressort
	Dimension	170 mm

FREINS

Avant	Modèle	Braktek hydraulique avec un disque de 185 mm
	Étrier	4 pistons
Arrière	Modèle	Braktek hydraulique avec un disque de 150 mm
	Étrier	2 pistons



CAPACITÉS

Combustible	Type	Essence
	Capacité	2,3 litres
	Mélange	0,75% huile 2T
Liquide de refroidissement	Type	Castrol Radicool SF Premix
	Capacité	600 ml
Huile d'embrayage	Type	Huile minérale
Huile boîte à vitesse	Type	CASTROL TRANSMAX Z
	Capacité	375 ml
Liquide de freins	Type	DOT 4



MOTEUR

Cylindré	300 cc	247 cc
Type	2T Monocylindrique	2T Monocylindrique
Refroidissement	Par eau	Par eau
Diamètre x longueur	79 x 60 mm	72,5 x 60 mm
Alimentation	Alimentation électronique	Alimentation électronique
Compression	8,7:1	8,8:1
Potentiel maximum déclaré	31 CV / 9200 rpm	25 CV / 9200 rpm
Couple maximum déclaré	4,9 kg·m / 4500 rpm	4,0 kg·m / 4500 rpm
Bougies	Modèle	BPMR6A
	Tolérance	0,7 mm

TRANSMISSION

Embrayage	Multidisque à bain d'huile	Multidisque à bain d'huile
Rapport	6 rapports	6 rapports
Transmission secondaire	Chaîne (9/38z)	Chaîne (9/38z)



CONTACT US

GENERAL INFORMATION

info@vertigomotors.com

(+34) + 34 931 701 655



Vertigo