

FACTORY PARTS



FOR 50 ONLY



FOR SUPERMOTO



FOR BIGY® ONLY



FOR GP ONLY



ARRO® TIRES



DAYTONA® ENGINES



ENGI® FORK



MIKUNI® CARBURETORS



KEIHIN® CARBURETORS



SPECIAL PARTS



NIBBI CARBURETORS®



KENDA® TIRES



DNM® SUSPENSIONS



TWINAIR® FILTERS



GAMME 2024 RANGE 2024

YCF 50A	10
LITE F88S	14
LITE F125	16
START F88SE	18
START F125	20
START F125SE	22
PILOT F125	24
PILOT F150E	26
FACTORY SP2 F150	28
FACTORY SP3 F190	30
BIGY F125 MX	32
BIGY F150 MX	34
BIGY F150 MX-E FACTORY	36
BIGY F190 MX FACTORY DAYTONA®	38
SM F125	40
SM F155	42
SM F190	44
GP 107A	46
GP 157	48
GP 187	50
PIÈCES GP/ GP PARTS	52
PADDOCK/ PADDOCK	58
TEXTILES/ APPAREL	60

ACCESSOIRES PLASTIQUES PLASTIC PARTS

KITS DÉCO/ GRAPHIC KITS	62
PERSONNALISATION/ CUSTOMIZATION	67
KITS PLASTIQUES/ PLASTIC KITS	68

PIÈCES MOTO CYCLE PARTS

GUIDONS/ HANDLEBARS	76
POIGNÉES/ LEVERS	78
FOURCHES/ FORKS	80
CADRES/ FRAMES	83
SELLES/ SEATS	84
RÉSERVOIRS/ FUEL TANKS	85
FREINS/ BRAKES	86
BRAS OSCILLANTS/ SWING ARMS	94
AMORTISSEURS/ SHOCK ABSORBERS	96
ROUES/ WHEELS	97
JANTES & MOYEUX/ RIMS & HUBS	97
PNEUS/ TIRES	104
REPOSE-PIEDS & SABOTS/ FOOT PEGS & SKID PLATES	106
SÉLECTEURS/ SHIFT LEVERS	107
KITS CHÂÎNES/ SPROCKET KITS	108
OUTILS/ TOOLS	110
ENGI®/ ENGI®	112
PIÈCES SPÉCIALES SUPERMOTARD/ SUPERMOTO FACTORY SPECIAL PARTS	114

PIÈCES MOTEUR ENGINE PARTS

MOTEURS DAYTONA®/ DAYTONA® ENGINES	118
MOTEURS/ ENGINES	119
KITS MOTEUR/ ENGINE KITS	120
EMBRAYAGE/ CLUTCH	123
CARBURATEURS/ CARBURETORS	125
FILTRES À AIR/ AIR FILTERS	127
ÉCHAPPEMENTS/ EXHAUSTS	128
FILTRES & RADIATEURS/ FILTERS & COOLERS	131
ALLUMAGE/ IGNITION	132
PIÈCES RACING DAYTONA®/ DAYTONA® RACING PARTS	134
PIÈCES D'ORIGINE DAYTONA®/ DAYTONA® PARTS	135

INDEX - FRENCH 2024

A

AIGUILLE DE CARBURATEUR.....	125
ALLUMAGE.....	132/134
AMORTISSEUR.....	96/113
ANTIPARASITE.....	133
ARBRE DE BOÎTE.....	122
ARRACHE VOLANT.....	110
ATTACHE RAPIDE DE CHAÎNE.....	108
ATTACHE SILENCIEUX.....	128/129
AXE DE BRAS OSCILLANT.....	95
AXE DE ROUE.....	101
AXE DE PLAQUETTE DE FREIN.....	86

B

BÂCHE MOTO.....	58
BAGUE DE FOURCHE.....	80/112
BANDEROLE.....	58
BANNER.....	58
BARNUM.....	58
BARRE DE REPOSE-PIED.....	106
BATTERIE.....	132
BAVETTE D'AMORTISSEUR.....	96
BÉQUILLE.....	59/83
BOBINE D'ALLUMAGE.....	132
BOÎTE À AIR.....	127
BONNET.....	60
BOUCHON DE CARTER D'ALLUMAGE.....	120
BOUCHON DE RÉSERVOIR.....	85
BOUCHON DE VALVE.....	104
BOUCHON DE VIDANGE.....	131
BOUCLE ARRIÈRE.....	83
BOUGIE.....	133
BRAS OSCILLANT.....	94
BRIDE DE POT.....	128

C

CÂBLE DE GAZ.....	79
CÂBLE D'EMBRAYAGE.....	79
CÂBLE DE PÉDALE DE FREIN.....	90
CACHE CULASSE.....	134
CACHE FILTRE À HUILE.....	134
CACHE POUSSIÈRE.....	112
CADRE.....	83
CAGE DE FILTRE À AIR.....	127

CALE PLASTIQUE DE PIPE D'ADMISSION.....	126
CALE DE PONTET DE GUIDON 20 mm.....	81
CAOUTCHOUC D'EMBRAYAGE.....	79
CAOUTCHOUC DE LEVIER DE FREIN.....	79
CAOUTCHOUC D'ÉTRIER.....	89
CAPOT DE MAÎTRE-CYLINDRE FREIN.....	93
CARBURATEUR.....	125
CARTER D'ALLUMAGE.....	120/121
CARTER D'EMBRAYAGE.....	123
CASQUETTE.....	60
CDI.....	132
CERCEAU DE ROUE.....	100/101
CHAÎNE.....	108
CHAÎNE DE DÉMARREUR.....	120/134
CHAÎNE DE DISTRIBUTION.....	120/134
CHAISE PLIABLE.....	58
CHAMBRE À AIR.....	104
CHAPE DE MAÎTRE-CYLINDRE.....	90
CHAPEAU.....	61
CHARGEUR BATTERIE.....	132
CLÉ À BOUGIE.....	110
CLÉ À RAYON.....	110
CLOCHE D'EMBRAYAGE.....	124
COCOTTE D'EMBRAYAGE.....	79
COLLECTEUR.....	130
COMPTEUR D'HEURES.....	133
CONTACTEUR À CLÉ.....	132
COUPE CIRCUIT.....	133
COURONNE.....	108/109
COURONNE D'EMBRAYAGE.....	123
COUVERCLE DE FILTRE À AIR.....	127
COUVRES RAYONS.....	101
COUVRE RÉSERVOIR.....	85
CULASSE.....	122
CYLINDRE.....	122

D

DAYTONA® (PIÈCES).....	134-139
DÉRIVE CHAÎNE.....	110
DÉMONTE PNEU.....	110
DÉMONTE NOIX EMBRAYAGE.....	110
DÉCO DE CADRE.....	62
DIABOLO CNC.....	94
DISQUE DE FREIN.....	92
DISQUE D'EMBRAYAGE.....	123
DONUTS.....	79
DURITE D'ESSENCE.....	85
DURITE DE FREIN.....	88/89
DURITE D'HUILE RADIATEUR.....	130

E

ÉCHAPPEMENT.....	129-130
ÉCHAPPEMENT COMPLET.....	129
ÉCROU DE BÉQUILLE.....	83
ÉCROU DE COLONNE DE DIRECTION.....	82
EMBOUT DE PÉDALE DE FREIN.....	90
EMBOUT DE POT.....	128/129
EMBOUT DE MAÎTRE-CYLINDRE FREIN.....	90
EMBOUT PLASTIQUE DE GUIDON.....	79
EMBRAYAGE COMPLET.....	123
ENGI® (PIÈCES).....	112/113
ENTRETOISE D'AMORTISSEUR.....	96
ENTRETOISE DE ROUE.....	102
ÉPURATEUR D'HUILE.....	130
ÉTRIER DE FREIN.....	86/88-89

F

FAISCEAUX ÉLÉCTRIQUES.....	132
FEUTRINE.....	58
FILTRE À AIR.....	127
FILTRE À HUILE.....	130
FOND DE JANTE.....	104
FOURCHE.....	80/112
FOURCHETTE DE BOÎTE.....	122
FREIN ARRIÈRE.....	86-89
FREIN AVANT.....	86-88
FREIN FILET.....	110

G

GARDE BOUE ARRIÈRE.....	70/71
GARDE BOUE AVANT.....	68/71/73
GICLEUR.....	125
GRIPSTER.....	101
GUIDE DE CHAÎNE.....	95
GUIDON.....	77

H

HUBLLOT À HUILE.....	131
----------------------	-----

J

JANTES.....	100-101
JAUGE À HUILE.....	131
JEU DE CALES MOTEUR.....	110
JEU DE RAYONS.....	101
JOINT DE BOUCHON DE RÉSERVOIR.....	85
JOINT DE CARTER D'EMBRAYAGE.....	124
JOINT DE COLONNE DE DIRECTION.....	82
JOINT DE CUVE POUR CARBURATEUR.....	125
JOINT PAPIER DE PIPE D'ADMISSION.....	126

JOINT DE POT	128
JOINT DE QUEUE DE SOUPAPE.....	122
JOINT SPY DE FOURCHE	80/112
JOINT SPY DE TIGE COMMANDE D'EMBRAYAGE	124
JOINT SPY DE KICK	124
JOINT SPY DE PSB	124
JOINT SPY DE ROUE.....	101
JOINT SPY DE SÉLECTEUR	124

K

KICK	107
KIT 212cc	134
KIT ARBRE À CAMES RACING	124/134
KIT DÉCO	62-66
KIT DÉCO DE CADRE	62
KIT DÉPART	112
KIT FREIN	86/87/88
KIT LAMPE	74
KIT PISTON	121/134
KIT PLASTIQUE	68-73
KIT RABASSE.....	96
KIT RÉFECTION D'AMORTISSEUR	113
KIT RÉFECTION ENTRETOISE AXE AMORTISSEUR ...	113
KIT RÉFECTION DE FOURCHE.....	80
KIT RONDELLE CNC	74
KIT ROUE SUPERMOTARD	97
KIT ROULEMENT DE COLONNE DE DIRECTION	82
KIT STABILISATEUR	12
KIT SUPERMOTARD	107/114
KIT VIS.....	74/92/109/125

L

LAINA DE ROCHE.....	128
LEVIER D'EMBRAYAGE.....	78/79
LEVIER DE FREIN	78/79/86

M

MAÎTRE-CYLINDRE	86-88
MANCHON DE BOÎTE À AIR	127
MANCHON DE PIPE D'ADMISSION	126
MOTEUR	118-119
MOUSSE DE GUIDON	76
MOYEU	102

N

NUMÉROS	67
---------------	----

O

ORIFLAMME	58
OUÏE DE RADIATEUR	68/71

OUTILLAGE.....	110/112
----------------	---------

P

PARAPLUIE	60
PASSE DURITE DE FREIN AVANT.....	74
PATTE DE CADRE	82
PATTE DE FREIN CNC.....	86
PATIN DE BRAS OSCILLANT	95
PATIN DE CHAÎNE	95
PÉDALE DE FREIN	90
PIÈCES D'ORIGINE DAYTONA®.....	135-139
PIÈCES GP	52-56
PIGNON	122/124
PIGNON DE CLOCHE D'EMBRAYAGE	122
PIGNON DE SORTIE DE BOÎTE	108
PIPE D'ADMISSION	126/134
PISTON	121/134
PLANCHE DE STICKERS.....	67
PLAQUE AVANT.....	68/72
PLAQUES LATÉRALES.....	69/72
PLAQUE PHARE.....	74
PLAQUETTES DE FREIN	92
PLATEAU D'ALLUMAGE.....	132
PLATINE RÉGLABLE AVEC REPOSE PIED.....	106
PNEU.....	104-105
POCHETTE DE JOINTS	122
POIGNÉE DE GAZ	78
POIGNÉES CAOUTCHOUC.....	79
POIGNÉES DE PLAQUES LATÉRALE.....	69/72
POINTEAU DE CARBURATEUR.....	125
POLO	60
PONTET DE GUIDON	81
PROTECTION DE FOURCHE.....	70
PROTECTION DE PIGNON SORTIE BOÎTE.....	109
PROTECTION SM	106
PROTÈGE DISQUE ARRIÈRE.....	95
PROTÈGE DISQUE AVANT	74
PROTÈGE LEVIER	76
PROTÈGE MAIN	76
PROTÈGE MAÎTRE-CYLINDRE.....	90

R

RAYONS.....	101
RADIATEUR D'HUILE	131
RÉGULATEUR DE TENSION	132
RELAIS DE DÉMARREUR	132
REPOSE PIED.....	106
RÉSERVOIR.....	85
RÉSERVOIR RÉCUPERATEUR HUILE/ ESSENCE	106
RESSORT D'AMORTISSEUR	96

RESSORT DE BÉQUILLE	83
RESSORT DE KICK.....	107
RESSORT DE PÉDALE DE FREIN.....	90
RESSORT DE POT	128/129
RESSORT POUR ÉTRIER RADIAL.....	86
ROBINET D'ESSENCE	85
ROUES.....	12/97-100
ROULEMENT DE COLONNE DE DIRECTION.....	82
ROULEMENT DE ROUE.....	101
ROULEMENT DE BRAS OSCILLANT	95
ROULETTE DE CHAÎNE.....	95
RUBALISE DE TERRAIN	58

S

SABOT.....	106
SAC À DOS/TRANSPORT	61
SEGMENT	121
SÉLECTEUR	107
SELLE.....	84
SILENCIEUX	129
SOUPAPE.....	122
STARTER AU GUIDON	126
SUPPORT DE COMPTEUR D'HEURES	133
SURFILTRE À AIR	127
SWEAT	60

T

TAPIS	59
TÉ DE FOURCHE	80/81
TEESHIRT.....	60
TENDEUR DE CHAÎNE	109
TIGE DE COMMANDE D'EMBRAYAGE	124
TONNELLE	58
TRÉPIED.....	59

V

VALVE COUDÉE 90°.....	97
VALVE PRISE AIR	85
VILEBREQUIN.....	121
VIS DE BÉQUILLE.....	83
VIS DE COURONNE	109
VIS DE CUVE.....	125
VIS DE DISQUE	92
VIS DE RALENTI.....	125
VIS ET ÉCROU TENDEUR DE CHAÎNE	95
VIS DE PLAQUETTE DE FREIN	92
VIS DE RÉGLAGE DE LA POIGNÉE DE GAZ	78
VIS RENFORCÉES POUR MOTEUR	83
VIS DE RICHESSE	125
VISSERIE.....	74/83/109

INDEX - ENGLISH

2024

A

AIR FILTERS.....	127
AIRBOX CAPS.....	127
AIRBOX RUBBER SLEEVES.....	127
AIRBOXES.....	127
APPAREL.....	60
AXLES.....	101

B

BACKPACK.....	61
BANNER ROLL.....	58
BANNERS.....	58
BAR END CAPS.....	79
BAR MOUNTS.....	81
BATTERY CHARGER.....	132
BEANIE.....	60
BEARINGS.....	95/101
BIKE STANDS.....	59
BOLT KIT FOR AXLE BLOCK.....	95
BOLT KIT FOR BRAKE DISC.....	92
BOLT KITS FOR FUEL TANK.....	74
BOLT KIT FOR PLASTIC KIT.....	74
BOLT KIT FOR SEAT.....	74
BOLT KIT FOR SPROCKET.....	109
BRAKE CALIPERS.....	86-89
BRAKE CLEVIS.....	90
BRAKE DISCS.....	92
BRAKE GUARDS (FRONT).....	74
BRAKE HOSES.....	74
BRAKE LEVERS.....	78/79/86
BRAKE LEVER RUBBERS.....	79
BRAKE MASTER CYLINDERS.....	86/88
BRAKE PADS.....	92
BRAKE PEDALS.....	90
BRAKE RESERVOIR COVER.....	93
BRAKE SYSTEMS (COMPLETE).....	86-89

C

CAMSHAFT KIT.....	124/134
CAP BIG VIEW HOLE.....	120
CAPS.....	60
CARBURETOR FLOAT.....	125
CARBURETORS.....	125
CARBURETOR BOOT.....	126

CATCH CAN.....	106
CDI.....	132
CHAIN GUIDES.....	95
CHAIN LINKS.....	110
CHAIN SLIDERS.....	95
CHAIN TENSIONERS.....	95
CHAIN TOOLS.....	110
CHAINS.....	108
CHOKE LEVER.....	126
CLUTCH ASSEMBLY.....	123
CLUTCH BRACKET.....	79
CLUTCH CABLES.....	79
CLUTCH CONTROL OIL SEAL.....	124
CLUTCH COVER.....	123
CLUTCH FOR KICKSTARTER.....	123/124
CLUTCH LEVER RUBBERS.....	79
CLUTCH LEVERS.....	78-79
CLUTCH SPROCKET.....	122/123
CLUTCH TOOLS.....	110
COUNTERSHAFT SPROCKET.....	108
COUNTERSHAFT SPROCKET GUARD.....	109
CRANKSHAFTS.....	121
CUSTOM NUMBERS.....	67
CYLINDERS.....	122

D

DAYTONA ENGINE 212 KIT.....	134
DAYTONA® PARTS.....	134-139
DISCS.....	92
DISC GUARD.....	74/95
DUST SEALS.....	101

E

ENGI®.....	112/113
ENGINE ADJUSTMENT GAUGES.....	110
ENGINE BASH PLATE STEEL.....	106
ENGINE KITS.....	120/134
ENGINE REINFORCED BOLT SETS.....	83
ENGINES (COMPLETE).....	118/119
EXHAUSTS.....	128/129/130
EXHAUST END.....	128/129
EXHAUST PIPE.....	128/129
EXHAUST SPRING.....	128/129
EXHAUST VALVE.....	122

F

FENDER.....	68/70/71/73
FILTER.....	127
FLAGS (PROMOTIONAL).....	58
FLYWHEEL REMOVER.....	110

FOAM AIR FILTER.....	127
FOLDABLE LEVERS.....	78
FOLDING CHAIR.....	58
FOOT PEG MOUNT BAR.....	106
FOOT PEGS.....	106
FORK AIR BLEEDER.....	80
FORK BUSHINGS ENGI®.....	112
FORK GUARDS.....	70
FORK OIL SEALS.....	80/112
FORK SEAL REPAIR KIT.....	80/112
FORKS.....	80/112
FORK TOOL.....	112
FRAMES.....	83
FUEL CAPS.....	85
FUEL HOSES.....	85
FUEL TANKS.....	85
FUEL PETCOCK.....	85
FUEL VENT CAP.....	85

G

GASKET SETS.....	122/124/125
GEARBOX FORK (REINFORCED).....	122
GEARBOX SHAFT.....	122
GEARBOX SHAFT (COMPLETE MAIN).....	122
GEARBOX SHAFT (COMPLETE SECONDARY).....	122
GP PARTS.....	52-56
GRAPHIC KITS.....	62-66
GRAPHICS FOR FRAME.....	62
GRIPS.....	79
GRIP DONUTS.....	79

H

HANDGUARDS.....	76
HANDLEBAR PADS.....	76
HANDLEBARS.....	77
HATS.....	60/61
HEAD LIGHTS.....	74
HEIGHT ADJUSTMENT KIT.....	96
HIGH TENSION IGNITION COIL.....	132
HOLESHOT DEVICE.....	112
HOODIE.....	60
HOUR METER.....	133
HUB SPACERS.....	102
HUBS.....	102

I

IDLE SCREW + SPRING.....	125
IGNITION COVER.....	120
IGNITION SWITCH.....	132
INLET PIPE.....	126

INLET VALVE.....	122
INTAKE GASKET.....	126
INTAKE MANIFOLD.....	126

K

KICKSTAND (ADJUSTABLE).....	83
KICKSTAND SPRING.....	83
KICKSTARTER LEVER OIL SEAL.....	124
KICKSTARTER LEVERS.....	107
KICKSTARTER SPROCKET.....	124
KILL SWITCH.....	132

L

LIGHT.....	74
LEVER PROTECTION.....	76
LAUNCH CONTROL.....	110

M

MAGNETIC DRAIN PLUG.....	131
MAGNETO.....	132
MAIN JET.....	125
MOTORCYCLE COVER.....	58
MUD FLAP.....	96
MUDGUARDS.....	12/68/70/71/73
MUFFLER.....	128/129
MUFFLER CLAMPS.....	128/129
MUFFLER SPARK ARRESTOR.....	128

N

NEEDLE VALVE + SPRING.....	125
NUMBER PLATES.....	68/69/72
NUMBERS (CUSTOM).....	67
NUT FOR STEERING STEM.....	82

O

OIL COOLER.....	131
OIL DIPSTICK.....	131
OIL DRAIN PLUG.....	131
OIL FILTER.....	131
OIL LEVEL SIGHT GLASS.....	131
OIL SEAL.....	101
OIL SEAL ASSEMBLY TOOLS.....	110
OIL SEAL FOR COUNTERSHAFT SPROCKET.....	124
OIL STEEL LINE RETAINER.....	74
OVAL MUFFLER CLAMP.....	128

P

PISTON KITS.....	120/134
PISTON RING SETS.....	120
PIT TENT (3X3M).....	58

PLASTIC KITS.....	68-73
POLO.....	60
PUSH ROD.....	124

R

REAR BRAKE LEVER TIPS.....	90
REAR SPOOL.....	94
REGULATOR.....	132
REMOTE SWITCH.....	133
RIM LOCKS.....	101
RIMS.....	100/101
RUBBER MANIFOLD SET.....	126
RUBBER MAT.....	59

S

SEAL FOR FUEL TANK CAP.....	85
SEAL FOR STEERING STEM.....	82
SEATS.....	84
SHAFT.....	122
SHIFT LEVERS.....	107
SHOCK ABSORBERS.....	96/113
SHOCK ABSORBERS REPAIR KIT.....	113
SHOCK ABSORBERS SPACER KIT.....	113
SHOCK ABSORBERS SPRING.....	96
SIDE PLATES.....	68/71
SKID PLATE.....	106
SLOW JET.....	125
SPACERS.....	96/102
SPACERS FOR BAR MOUNT.....	81
SPARK ARRESTOR.....	128
SPARK PLUG REMOVAL TOOL.....	110
SPARK PLUGS.....	133
SPOKE SKINS.....	101
SPOKE TOOL.....	110
SPOKE WRENCH.....	110
SPOKES.....	101
SPROCKETS.....	108/109
SPROCKET GUARD.....	109
SPROCKET LOCKING TAB.....	109
STABILIZED WHEEL KIT.....	12
STAND SCREW & NUT.....	83
STANDARD LEVERS.....	79
STARTER CHAIN.....	120
STARTER RELAY.....	132
STICKER SHEET (YCF).....	67
SUBFRAMES.....	83
SUPERMOTARD CATCH TANK KIT.....	107
SUPERMOTARD RACING PARTS.....	114-117
SUPERMOTARD TEFLON PROTECTION SET.....	107
SUPPORTING PLATE FOR HOUR METER.....	133

SWING ARMS.....	94
SWING ARM SLIDER.....	95
SWITCH REMOTE CUT OFF (50CC).....	133

T

TAIL LIGHT.....	74
TANK BOLT.....	125
TANK COVER.....	85
TANK SHROUDS.....	68/71
TAPER ROLLER BEARINGS.....	82
THREADLOCK.....	110
THROTTLE ADJUSTING SCREW.....	78
THROTTLE ASSEMBLY.....	79
THROTTLE CABLES.....	79
THROTTLE HANDLE.....	78
TIMING SPROCKET.....	120/134
TIRES.....	104/105
TIRE LEVER.....	110
TIRE VALVE CAPS.....	104
TIRE VALVE INNER.....	97
TOOLS.....	110/112
TRACK TAPE.....	58
TRAINING WHEEL KIT.....	12
TRANSPORT BAG.....	61
TRIPLE CLAMPS.....	80/81
T-SHIRTS.....	60
TUBES.....	12/104

U

UMBRELLA.....	60
---------------	----

V

VALVE ADJUSTMENT TOOL.....	110
VALVE CAP.....	104
VALVE STEM SEAL.....	122

W

WASHER FOR STEERING STEM NUT.....	82
WHEEL ASSEMBLY (COMPLETE).....	12/97-100
WIRING HARNESS.....	132

Y

YCF PLASTIC HANDLES ON SIDE PLATES.....	69/72
---	-------



YCF 50A

STANDARD 550mm/ 21 in.
LOW 530mm/ 20 in.

l : 580mm/ w: 23 in.



42Kg/ 92 lbs

P.11

870mm/ w: 34 in.

1280mm/ w: 50 in.



LITE F88S

LITE F125

710mm/ 28 in.
l : 740mm/ w: 29 in.

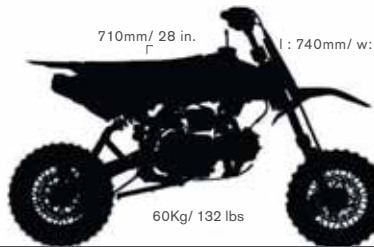

60Kg/ 132 lbs

P.15

1083mm/ 42 in.

1500mm/ 59 in.

750mm/ 30 in.
l : 740mm/ w: 29 in.

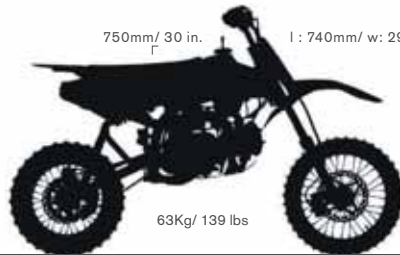

63Kg/ 139 lbs

P.17

1110mm/ 44 in.

1590mm/ 62 in.



START F88SE

START F125 START F125SE

720mm/ 28 in.
l : 740mm/ w: 29 in.



65Kg/ 143 lbs

P.19

1045mm/ 41 in.

1460mm/ 57 in.

765mm/ 30 in.
l : 740mm/ w: 29 in.

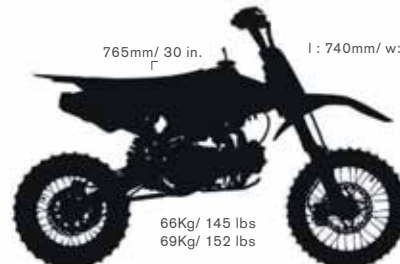

66Kg/ 145 lbs
69Kg/ 152 lbs

P.21

P.23

1120mm/ 44 in.

1595mm/ 62 in.

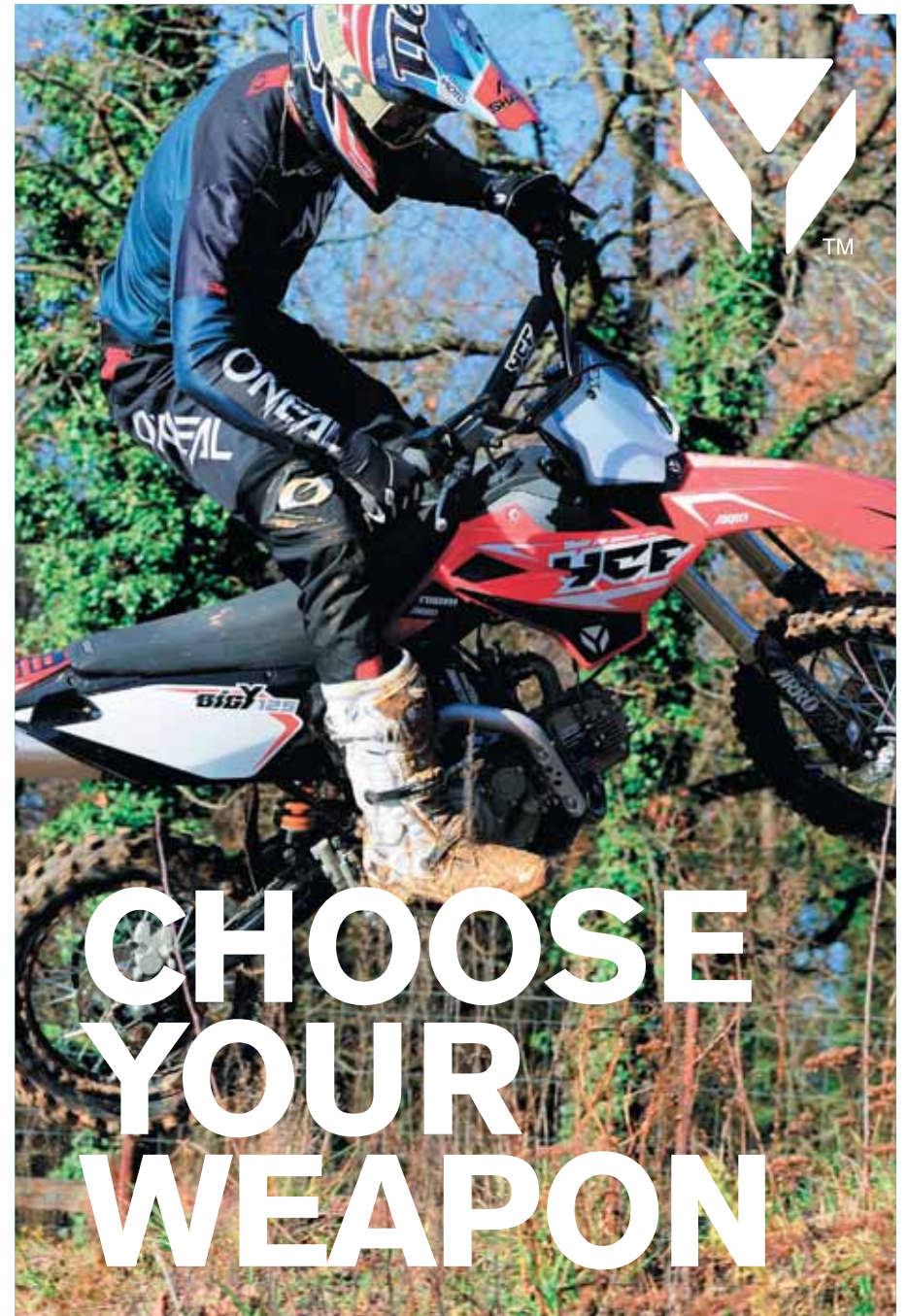

CHOOSE YOUR WEAPON

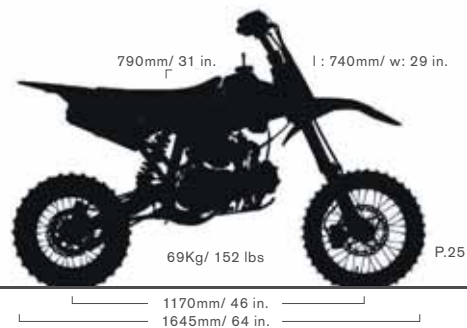
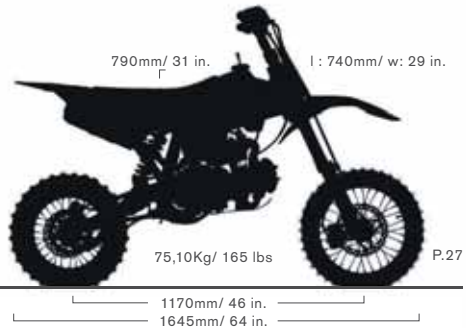
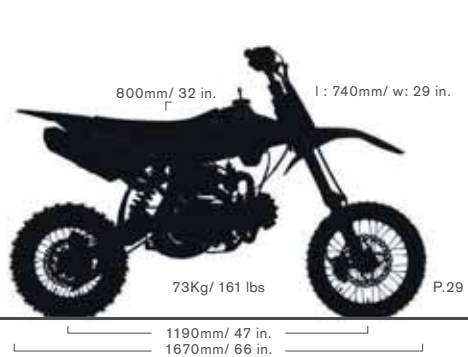
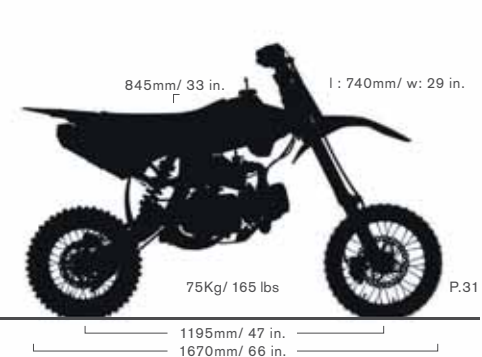
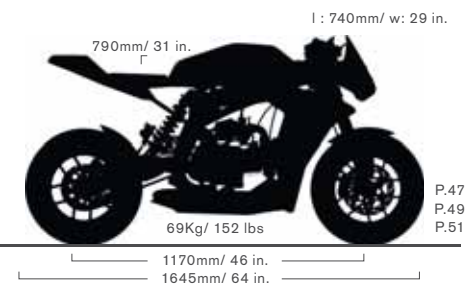
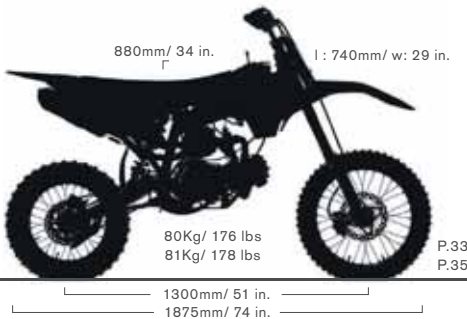
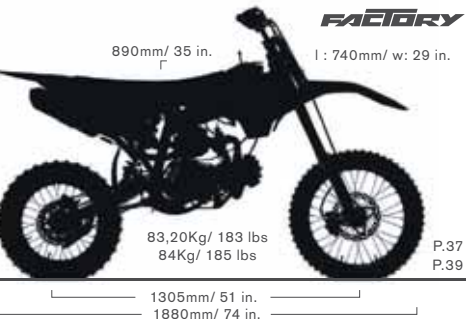
PILOT**PILOT F125****PILOT F150E****FACTORY****FACTORY SP2 F150****FACTORY SP3 F190****SM F125****SM F155
SM F190****GP 107A
GP 157
GP 187****BIGY F125 MX
BIGY F150 MX****BIGY F150 MX-E FACTORY
BIGY F190 MX FACTORY DAYTONA®****FACTORY****BIGY F150 MX-E FACTORY XL
BIGY F190 MX DAYTONA® XL**



DISPONIBLE/ AVAILABLE PAGE 12

€1499

SPÉCIFICATIONS

**MOTEUR: MONO CYLINDRE REFROIDISSEMENT
À AIR/ AUTOMATIQUE**
FOURCHE INVERSÉE 530mm
SUSPENSION ARRIÈRE 200mm
PNEUS AV. & AR.: 2.50/10 - 2.50/10

SPECIFICATIONS

**ENGINE TYPE: SINGLE CYLINDER AIR
COOLING/ AUTOMATIC GEAR BOX**
530mm UPSD FORK
200mm REAR SUSPENSION
FRONT & REAR TIRES: 2.50/10 - 2.50/10

**2024 YCF 50 A
FUN FANATIC**

POINTS FORTS & NOUVEAUTÉS 2024

MOTEUR 4T 50CC
STARTER AU GUIDON
DÉMARREUR ÉLECTRIQUE
PRISE RAPIDE DE CHARGEUR DE BATTERIE
POIGNÉE GAZ RÉGLABLE
42 KGS SEULEMENT
FREIN AVANT ET FREIN ARRIÈRE HYDRAULIQUE
TÉ FOURCHE SUPÉRIEUR 4 POSITIONS
**BRAS OSCILLANT AVEC 2 POSITIONS POUR
RÉGLER LA HAUTEUR DE LA MOTO**

HIGHLIGHTS & 2024 NEW FEATURES

50CC 4 STROKE ENGINE
START BUTTON
ELECTRIC START
FAST BATTERY CHARGING
ADJUSTABLE THROTTLE
ONLY 92 LBS IN WEIGHT
HYDRAULIC BRAKE SYSTEM
UPPER CLAMP 4 POSITIONS BAR MOUNT
**2 POSITION SWING ARM TO ADJUST
THE BIKE HEIGHT**



YCF 50A



STANDARD 550mm/ 21 in.
LOW 530mm/ 20 in.

 **42Kg/ 92 lbs**

L : 580mm/ W: 23 in.

870mm/ 34 in.

1270mm/ 50 in.



FOR 50 ONLY

KIT STABILISATEUR POUR YCF 50
STABILIZER WHEEL KIT FOR YCF 50

N° YC50-2105

€ 119

ROUE POUR KIT STABILISATEUR
WHEEL FOR STABILIZER WHEEL KIT

01 N° YC50-2101

€ 25

CHAMBRE À AIR POUR KIT STABILISATEUR
TUBE FOR STABILIZER WHEEL KIT

03 N° YC50-2106

€ 8

GARDE BOUE POUR KIT STABILISATEUR
MUDGUARD FOR STABILIZER WHEEL KIT

02 N° YC50-2103 (GAUCHE/ LEFT)
02 N° YC50-2104 (DROIT/ RIGHT)

€ 25



PAGE 85

PAGE 79

PAGE 79

PAGE 104



PAGE 73

PAGE 85

PAGE 82

PAGE 133

PAGE 109

PAGE 85

PAGE 77



€ 1299

SPÉCIFICATIONS

MOTEUR: MONO CYLINDRE 4 TEMPS 88cc
4 VITESSES EMBRAYAGE SEMI AUTOMATIQUE
FOURCHE 600mm
SUSPENSION ARRIÈRE 265mm
PNEUS AV. & AR. : 250/10 - 300/10

SPECIFICATIONS

ENGINE TYPE: SINGLE CYLINDER 4 STROKE 88cc
4 GEARS (N1234) WITH AUTOMATIC CLUTCH
600mm FORK
265mm REAR SUSPENSION
FRONT & REAR TIRES: 250/10 - 300/10

2024 LITE F88S LIGHT IS RIGHT!

POINTS FORTS & NOUVEAUTÉS 2024

**POIGNÉE DE GAZ RÉGLABLE
SEMI-AUTOMATIQUE**
SELLE BASSE COMPATIBLE PAGE 84
FILTRE À AIR YCF
POIGNÉE CAOUTCHOUC YCF
KIT RABASSE AMORTISSEUR PAGE 96
TÉ FOURCHE SUPÉRIEUR 3 POSITIONS

HIGHLIGHTS & 2024 NEW FEATURES

ADJUSTABLE THROTTLE
SEMI-AUTOMATIC
COMPATIBLE LOW SEAT PAGE 84
YCF AIR FILTER
YCF GRIPS
HEIGHT ADJUSTMENT KIT PAGE 96
UPPER CLAMP 3 POSITIONS BAR MOUNT

LTE 885



710mm/ 28 in.

 60Kg/ 132 lbs

L : 740mm/ W: 29 in.

1083mm/ 42 in.

1500mm/ 59 in.



€ 1399

SPÉCIFICATIONS

MOTEUR: MONO CYLINDRE 4 TEMPS 125cc
4 VITESSES EMBRAYAGE
FOURCHE 650mm
SUSPENSION ARRIÈRE 270mm
PNEUS AV. & AR.: 60/100/14 - 80/100/12

SPECIFICATIONS

ENGINE TYPE: SINGLE CYLINDER 4 STROKE 125cc
 4 GEARS (N1234)
 650mm FORK
 270mm REAR SUSPENSION
 FRONT & REAR TIRES: 60/100/14 - 80/100/12

2024 LITE F125
LIGHT? YOU BET!

POINTS FORTS & NOUVEAUTÉS 2024

POIGNÉE DE GAZ RÉGLABLE
EMBRAYAGE MANUEL
SELLE BASSE COMPATIBLE PAGE 84
FILTRE À AIR YCF
POIGNÉE CAOUTCHOUC YCF
KIT RABASSE AMORTISSEUR PAGE 96
TÉ FOURCHE SUPÉRIEUR 3 POSITIONS

HIGHLIGHTS & 2024 NEW FEATURES

ADJUSTABLE THROTTLE
 MANUAL CLUTCH
 COMPATIBLE LOW SEAT PAGE 84
 YCF AIR FILTER
 YCF GRIPS
 HEIGHT ADJUSTMENT KIT PAGE 96
 UPPER CLAMP 3 POSITIONS BAR MOUNT

UT 125



750mm/ 30 in.

 63Kg/ 139 lbs

L : 740mm/ W: 29 in.

1110mm/ 44 in.

1590mm/ 62 in.



€ 1599

SPÉCIFICATIONS

MOTEUR: MONO CYLINDRE 4 TEMPS 88cc
4 VITESSES EMBRAYAGE SEMI AUTOMATIQUE
FOURCHE INVERSÉE 600mm
SUSPENSION ARRIÈRE RÉGLABLE 265mm
PNEUS AV. & AR.: 60/100/12 - 300/10

SPECIFICATIONS

ENGINE TYPE: SINGLE CYLINDER 4 STROKE 88cc
4 GEARS (N1234) WITH AUTOMATIC CLUTCH
600mm UPSD FORK
265mm ADJUSTABLE REAR SUSPENSION
FRONT & REAR TIRES: 60/100/12 - 300/10

2024 START F88SE MAGIC BUTTON

POINTS FORTS & NOUVEAUTÉS 2024

DÉMARREUR ÉLECTRIQUE
SEMI-AUTOMATIQUE
POIGNÉE DE GAZ RÉGLABLE
BOUTON DE DÉMARREUR ÉTANCHE
SELLE BASSE COMPATIBLE PAGE 84
FILTRE À AIR YCF
POIGNÉE CAOUTCHOUC YCF
TÉ FOURCHE SUPÉRIEUR 3 POSITIONS

HIGHLIGHTS & 2024 NEW FEATURES

ELECTRIC STARTER
SEMI-AUTOMATIC
ADJUSTABLE THROTTLE
WATERPROOF START BUTTON
COMPATIBLE LOW SEAT PAGE 84
YCF AIR FILTER
YCF GRIPS
UPPER CLAMP 3 POSITIONS BAR MOUNT

START 88⁵



720mm/ 28 in.

 65Kg/ 143 lbs

L : 740mm/ W: 29 in.

1045mm/ 41 in.

1460mm/ 57 in.



€ 1599

SPÉCIFICATIONS

MOTEUR: MONO CYLINDRE 4 TEMPS 125cc
4 VITESSES EMBRAYAGE
FOURCHE INVERSÉE 660mm
SUSPENSION ARRIÈRE RÉGLABLE 270mm
PNEUS AV. & AR.: 60/100/14 - 80/100/12

SPECIFICATIONS

ENGINE TYPE: SINGLE CYLINDER 4 STROKE 125cc
 4 GEARS (N1234)
 660mm UPSD FORK
 270mm ADJUSTABLE REAR SUSPENSION
 FRONT & REAR TIRES: 60/100/14 - 80/100/12

2024 START F125 FAST & EASY

POINTS FORTS & NOUVEAUTÉS 2024

POIGNÉE DE GAZ RÉGLABLE
JOINT ÉTANCHE DE COLONNE DE DIRECTION
SELLE BASSE COMPATIBLE PAGE 84
KIT RABASSE ADAPTABLE PAGE 96
FILTRE À AIR YCF
POIGNÉE CAOUTCHOUC YCF
TÉ FOURCHE SUPÉRIEUR 3 POSITIONS

HIGHLIGHTS & 2024 NEW FEATURES

ADJUSTABLE THROTTLE
 SEALING WASHER FOR STEERING STEM
 COMPATIBLE LOW SEAT PAGE 84
 HEIGHT ADJUSTMENT KIT PAGE 96
 YCF AIR FILTER
 YCF GRIPS
 UPPER CLAMP 3 POSITIONS BAR MOUNT

START 125



765mm/ 30 in.

 66Kg/ 145 lbs

L : 740mm/ W: 29 in.

1120mm/ 44 in.

1595mm/ 62 in.



€ 1699

SPÉCIFICATIONS

MOTEUR: MONO CYLINDRE 4 TEMPS 125cc
4 VITESSES EMBRAYAGE SEMI AUTOMATIQUE
FOURCHE INVERSÉE 660mm
SUSPENSION ARRIÈRE RÉGLABLE 270mm
PNEUS AV. & AR.: 60/100/14 - 80/100/12

SPECIFICATIONS

ENGINE TYPE: SINGLE CYLINDER 4 STROKE 125cc
4 GEARS (N1234) WITH AUTOMATIC CLUTCH
660mm UPSD FORK
270mm ADJUSTABLE REAR SUSPENSION
FRONT & REAR TIRES: 60/100/14 - 80/100/12

2024 START F125SE
THE ULTIMATE BATTLE MACHINE

POINTS FORTS & NOUVEAUTÉS 2024

DÉMARREUR ÉLECTRIQUE
SEMI-AUTOMATIQUE
POIGNÉE DE GAZ RÉGLABLE
SELLE BASSE COMPATIBLE PAGE 84
FILTRE À AIR YCF
POIGNÉE CAOUTCHOUC YCF
TÉ FOURCHE SUPÉRIEUR 3 POSITIONS

HIGHLIGHTS & 2024 NEW FEATURES

ELECTRIC START
SEMI-AUTOMATIC
ADJUSTABLE THROTTLE
COMPATIBLE LOW SEAT PAGE 84
YCF AIR FILTER
YCF GRIPS
UPPER CLAMP 3 POSITIONS BAR MOUNT

START 125^S



765mm/ 30 in.

 69Kg/ 152 lbs

L : 740mm/ W: 29 in.

1120mm/ 44 in.

1595mm/ 62 in.



€ 1899

SPÉCIFICATIONS

MOTEUR: MONO CYLINDRE
4 TEMPS 125cc/ 4 VITESSES
FOURCHE INVERSÉE 735mm
SUSPENSION ARRIÈRE RÉGLABLE 330mm
PNEUS AV. & AR. : 60/100/14 - 80/100/12

SPECIFICATIONS

ENGINE TYPE: SINGLE CYLINDER
4 STROKE 125cc/ 4 GEARS (N1234)
FORK: 735mm UPSD FORK
REAR SUSPENSION: 330mm ADJUSTABLE
FRONT & REAR TIRES: 60/100/14 - 80/100/12



2024 PILOT F125 WORLD CLASS SIZE

POINTS FORTS & NOUVEAUTÉS 2024

BOÎTE À AIR
POIGNÉE CAOUTCHOUC YCF
TÉ FOURCHE SUPÉRIEUR 3 POSITIONS
MOTEUR 125 ZONGSHEN FIDDY RACER
CARBURATEUR NIBBI PE24SP

HIGHLIGHTS & 2024 NEW FEATURES

AIR BOX
YCF GRIPS
UPPER CLAMP 3 POSITIONS BAR MOUNT
ZONGSHEN 125 FIDDY RACER ENGINE
NIBBI PE24SP CARBURETOR

PILOT 125



790mm/ 31 in.

 69Kg/ 152 lbs

L : 740mm/ W: 29 in.

1170mm/ 46 in.

1645mm/ 64 in.



€ 1999

SPÉCIFICATIONS

MOTEUR: MONOCYLINDRE 4 TEMPS
150cc/ 4 VITESSES (N1234)
FOURCHE INVERSÉE 735mm
SUSPENSION ARRIÈRE RÉGLABLE 330mm
PNEUS AV. & AR.: 60/100/14 - 80/100/12

SPECIFICATIONS

ENGINE TYPE: SINGLE CYLINDER 4 STROKE
 150cc/ 4 GEARS (N1234)
 735mm UPSD FORK
 330mm ADJUSTABLE REAR SUSPENSION
 FRONT & REAR TIRES: 60/100/14 - 80/100/12

2024 PILOT F150 ⚡
THE ULTIMATE 150 ⚡

POINTS FORTS & NOUVEAUTÉS 2024

BOÎTE À AIR
POIGNÉE CAOUTCHOUC YCF
TÉ FOURCHE SUPÉRIEUR 3 POSITIONS
DÉMARREUR ELECTRIQUE
CARBURATEUR NIBBI PE24SP

HIGHLIGHTS & 2024 NEW FEATURES

AIR BOX
YCF GRIPS
UPPER CLAMP 3 POSITIONS BAR MOUNT
ELECTRIC START
NIBBI PE24SP CARBURETOR

PILOT 150



790mm / 31 in.

 75,10Kg / 165 lbs

L : 740mm / W: 29 in.

1170mm / 46 in.

1645mm / 64 in.



€ 2699

SPÉCIFICATIONS

MOTEUR: MONOCYLINDRE 4 TEMPS
150cc TYPE KLX/ 4 VITESSES
FOURCHE INVERSÉE RÉGLABLE 735mm
SUSPENSION ARRIÈRE RÉGLABLE 330mm
PNEUS AV. & AR.: 60/100/14 - 80/100/12 ARRO®

SPECIFICATIONS

ENGINE TYPE: SINGLE CYLINDER 4 STROKE
 150cc KLX TYPE/ 4 GEARS (N1234)
 735mm ADJUSTABLE UPSD FORK
 330mm ADJUSTABLE REAR SUSPENSION
 FRONT & REAR TIRES: 60/100/14 - 80/100/12 ARRO®

2024 FACTORY SP2 F150 RACE READY

POINTS FORTS & NOUVEAUTÉS 2024

MOYEURS AVANT/ ARRIÈRE ALUMINIUM CNC
COURONNE 5 TROUS
PNEUS ARRO® AVANT/ ARRIÈRE
CERCEAU DE ROUE ALUMINIUM 7116 NOIR
GRAISSEUR SUR COLONNE DE DIRECTION
SILENCIEUX ANTI-BRUIT
POIGNÉE CAOUTCHOUC YCF
BAVETTE AMORTISSEUR
TÉ FOURCHE SUPÉRIEUR 3 POSITIONS
BRAS OSCILLANT ALUMINIUM 420mm
CARBURATEUR NIBBI PE24SP

HIGHLIGHTS & 2024 NEW FEATURES

ALUMINUM CNC FRONT/ REAR HUBS
 5 BOLT SPROCKET
 FRONT/ REAR ARRO® TIRES
 ALUMINIUM 7116 BLACK RIMS
 GREASING ON STEERING STEM
 SPARK ARRESTOR
 YCF GRIPS
 MUD FLAP
 UPPER CLAMP 3 POSITIONS BAR MOUNT
 420mm ALUMINIUM SWING ARM
 NIBBI PE24SP CARBURETOR

FACTORY 150 SP2



800mm/ 32 in.

 73Kg/ 161 lbs

L : 740mm/ W: 29 in.

1190mm/ 47 in.

1670mm/ 66 in.



€ 3699

SPÉCIFICATIONS

MOTEUR: MONO CYLINDRE 4T, 4 SOUPAPES 190cc
DAYTONA® ANIMA® / 4 VITESSES
FOURCHE ENGI® INVERSÉE RÉGLABLE 800mm
SUSPENSION ARRIÈRE ENGI® RÉGLABLE 335mm
PNEUS AV. & AR. ARRO® : 60/100/14 - 80/100/12
CARBURATEUR NIBBI® 28

SPECIFICATIONS

ENGINE TYPE: DAYTONA® ANIMA® SINGLE CYLINDER 4V
 4 STROKE 190cc/ 4 GEARS (N1234)
 800mm ENGI® UPSD ADJUSTABLE FORK
 335mm ENGI® ADJUSTABLE REAR SUSPENSION
 FRONT & REAR ARRO® TIRES: 60/100/14 - 80/100/12
 NIBBI® 28 CARBURETOR

DAYTONA ENGI® ARRO™

2024 FACTORY SP3 F190
CATCH ME IF YOU CAN

POINTS FORTS & NOUVEAUTÉS 2024

BRAS OSCILLANT 460mm
TÉ 170mm
MOYEURS AVANT/ ARRIÈRE ALUMINIUM CNC
POIGNÉE CAOUTCHOUC YCF
BAVETTE AMORTISSEUR
GUIDON YCF 28,6MM
REPOSE PIED INOX
PÉDALE DE FREIN ALUMINIUM
GUIDE CHAÎNE RENFORCÉ
TÉ FOURCHE SUPÉRIEUR 3 POSITIONS

HIGHLIGHTS & 2024 NEW FEATURES

460mm SWINGARM
 170mm TRIPLE CLAMPS
 ALUMINUM CNC FRONT/ REAR HUBS
 YCF GRIPS
 MUD FLAP
 YCF FAT BAR 28,6mm HANDLEBAR
 INOX FOOT PEGS
 ALUMINUM BRAKE PEDAL
 REINFORCED CHAIN GUIDE
 UPPER CLAMP 3 POSITIONS BAR MOUNT

FACTORY 190 SP3

DAYTONA®



845mm / 33 in.

 75Kg / 165 lbs

L : 740mm / W: 29 in.

1195mm / 47 in.

1670mm / 66 in.



€ 2299

SPÉCIFICATIONS

MOTEUR: MONO CYLINDRE
4 TEMPS 125cc/ 4 VITESSES
FOURCHE INVERSÉE 785mm
SUSPENSION ARRIÈRE RÉGLABLE 355mm
PNEUS AV. & AR. : 70/100/17 - 90/100/14

SPECIFICATIONS

ENGINE TYPE: SINGLE CYLINDER
 4 STROKE 125cc/ 4 GEARS (N1234)
 FORK: 785mm UPSD FORK
 REAR SUSPENSION: 355mm ADJUSTABLE
 FRONT & REAR TIRES: 70/100/17 - 90/100/14

2024 BIGY F125 MX
EASY TO PICK UP

POINTS FORTS & NOUVEAUTÉS 2024

ROUE AVANT 17" / ARRIÈRE 14"
BOÎTE À AIR
POIGNÉE CAOUTCHOUC YCF
BAVETTE AMORTISSEUR
LEVIER DE FREIN PLIABLE
TÉ FOURCHE SUPÉRIEUR 3 POSITIONS
MOTEUR ZONGSHEN 125 FIDDY RACER
CARBURATEUR NIBBI® PE24

HIGHLIGHTS & 2024 NEW FEATURES

FRONT 17" / REAR 14" WHEEL
 AIR BOX
 YCF GRIPS
 MUD FLAP
 FOLDABLE FRONT BRAKE LEVER
 UPPER CLAMP 3 POSITIONS BAR MOUNT
 ZONGSHEN 125 FIDDY RACER ENGINE
 NIBBI® PE24 CARBURETOR

bigY 125



880mm/ 34 in.

 80Kg/ 176 lbs

L : 740mm/ W: 29 in.

1300mm/ 51 in.

1875mm/ 74 in.



€ 2499

SPÉCIFICATIONS

MOTEUR: MONO CYLINDRE
4 TEMPS 150cc/ 4 VITESSES
FOURCHE INVERSÉE 785mm
SUSPENSION ARRIÈRE RÉGLABLE 355mm
PNEUS AV. & AR. : 70/100/17 - 90/100/14

SPECIFICATIONS

ENGINE TYPE: SINGLE CYLINDER
4 STROKE 150cc/ 4 GEARS (N1234)
FORK: 785mm UPSD FORK
REAR SUSPENSION: 355mm ADJUSTABLE
FRONT & REAR TIRES: 70/100/17 - 90/100/14

2024 BIGY F150 MX BIGGER! FASTER! STRONGER!

POINTS FORTS & NOUVEAUTÉS 2024

ROUE AVANT 17"/ ARRIÈRE 14"
BOÎTE À AIR
POIGNÉE CAOUTCHOUC YCF
BAVETTE AMORTISSEUR
LEVIER DE FREIN PLIABLE
TÉ FOURCHE SUPÉRIEURE 3 POSITIONS
CARBURATEUR NIBBI® PE24

HIGHLIGHTS & 2024 NEW FEATURES

FRONT 17"/ REAR 14" WHEEL
AIR BOX
YCF GRIPS
MUD FLAP
FOLDABLE FRONT BRAKE LEVER
UPPER CLAMP 3 POSITIONS BAR MOUNT
NIBBI® PE24 CARBURETOR

bigY 150



880mm/ 34 in.

 81Kg/ 178 lbs

L : 740mm/ W: 29 in.

1300mm/ 51 in.

1875mm/ 74 in.



€ 2999

SPÉCIFICATIONS

MOTEUR: MONOCYLINDRE 4 TEMPS
150cc YX/ 4 VITESSES
DÉMARREUR ÉLECTRIQUE
FOURCHE INVERSÉE RÉGLABLE 800mm
SUSPENSION ARRIÈRE RÉGLABLE 355mm
PNEUS AV. & AR.: 70/100/17 - 90/100/14
CARBURATEUR NIBBI® 28

SPECIFICATIONS

ENGINE TYPE: SINGLE CYLINDER 4 STROKE
150cc YX/ 4 GEARS
ELECTRIC START
800mm ADJUSTABLE UPSD FORK
355mm ADJUSTABLE REAR SUSPENSION
FRONT & REAR TIRES: 70/100/17 - 90/100/14
NIBBI® 28 CARBURETOR

2024 BIGY F150 MX-E ⚡ FACTORY ELECTRIC START

POINTS FORTS & NOUVEAUTÉS 2024

ROUE AVANT 17"/ ARRIÈRE 14"
BOÎTE À AIR
JANTES ALUMINIUM 7116
MOYEURS AVANT/ ARRIÈRE ALUMINIUM CNC
POIGNÉE CAOUTCHOUC YCF
BAVETTE AMORTISSEUR
REPOSE PIED INOX
PÉDALE DE FREIN ALUMINIUM
GUIDE CHAÎNE RENFORCÉ
TÉ FOURCHE SUPÉRIEUR 3 POSITIONS

HIGHLIGHTS & 2024 NEW FEATURES

FRONT 17"/ REAR 14" WHEEL
AIR BOX
ALUMINUM 7116 RIMS
ALUMINUM FRONT/ REAR CNC HUBS
YCF GRIPS
MUD FLAP
INOX FOOT PEGS
ALUMINUM BRAKE PEDAL
REINFORCED CHAIN GUIDE
UPPER CLAMP 3 POSITIONS BAR MOUNT

WP 150 FACTORY



890mm / 35 in.

 89Kg / 196 lbs

L : 740mm / W: 29 in.

1305mm / 51 in.

1880mm / 74 in.



€ 3799

SPÉCIFICATIONS

MOTEUR: MONO CYLINDRE 4T, 4 SOUPAPES 190cc
DAYTONA® ANIMA® / 4 VITESSES
MOTEUR 4 VITESSES
FOURCHE ENGI® INVERSÉE RÉGLABLE 800mm
SUSPENSION ARRIÈRE ENGI® RÉGLABLE 355mm
PNEUS AV. & AR.: 70/100/17 - 90/100/14
CARBURATEUR NIBBI® 28

SPECIFICATIONS

ENGINE TYPE: DAYTONA® ANIMA® SINGLE CYLINDER 4V
 4 STROKE 190cc/ 4 GEARS (N1234)
 4 SPEED ENGINE
 800mm ENGI® UPSD ADJUSTABLE FORK
 355mm ENGI® ADJUSTABLE REAR SUSPENSION
 FRONT & REAR TIRES: 70/100/17 - 90/100/14
 NIBBI® 28 CARBURETOR

DAYTONA ENGI® ARRO™

2024 BIGY F190 MX FACTORY DAYTONA
FIRST TO THE FINISH LINE

POINTS FORTS & NOUVEAUTÉS 2024

BOÎTE À AIR
SURMOUSSE DE GUIDON CAOUTCHOUC 3D
MOTEUR 4 VITESSES
BRAS OSCILLANT ALUMINIUM
REPOSE PIED INOX
POIGNÉE CAOUTCHOUC YCF
BAVETTE AMORTISSEUR
GUIDON YCF 28,6MM
GUIDE CHAÎNE RENFORCÉ
TÉ FOURCHE SUPÉRIEUR 3 POSITIONS

HIGHLIGHTS & 2024 NEW FEATURES

AIR BOX
 RUBBER BAR PAD
 DAYTONA 4 SPEED ENGINE
 ALUMINUM SWING ARM
 INOX FOOTPEGS
 YCF GRIPS
 MUD FLAP
 YCF FAT BAR 28.6mm HANDLEBAR
 REINFORCED CHAIN GUIDE
 UPPER CLAMP 3 POSITIONS BAR MOUNT

BEY 190 FACTORY

DAYTONA



890mm / 35 in.

 84Kg / 185 lbs

L : 740mm / W : 29 in.

1305mm / 51 in.

1880mm / 74 in.



€ 1999

SPÉCIFICATIONS

MOTEUR: MONO CYLINDRE 4 TEMPS 125cc
4 VITESSES EMBRAYAGE
FOURCHE INVERSÉE 660mm
SUSPENSION ARRIÈRE RÉGLABLE 270mm
PNEUS AV. & AR.: 100/90/12 - 120/80/12

SPECIFICATIONS

ENGINE TYPE: SINGLE CYLINDER 4 STROKE 125cc
4 GEARS (N1234)
660mm UPSD FORK
270mm ADJUSTABLE REAR SUSPENSION
FRONT & REAR TIRES: 100/90/12 - 120/80/12

2024 SM F125 SUPERMOTO, SUPER FUN!

POINTS FORTS & NOUVEAUTÉS 2024

MOTEUR 125 ZONGSHEN FIDDY RACER
PNEUS KENDA K702
ROUES YCF
SELLE BASSE COMPATIBLE PAGE 84
KIT RABASSE ADAPTABLE PAGE 96
POIGNÉE CAOUTCHOUC YCF
TÉ FOURCHE SUPÉRIEUR 3 POSITIONS
CARBURATEUR NIBBI PE24SP
NOUVEAU GUIDON BAS

HIGHLIGHTS & 2024 NEW FEATURES

ZONGSHEN ENGINE 125 FIDDY RACER
KENDA TIRES K702
YCF WHEELS
COMPATIBLE LOW SEAT PAGE 84
HEIGHT ADJUSTMENT KIT PAGE 96
YCF GRIPS
UPPER CLAMP 3 POSITIONS BAR MOUNT
NIBBI PE24SP CARBURETOR
NEW LOWER HANDLEBAR

125



780mm/ 30 in.

 69Kg/ 152 lbs

L : 740mm/ W: 29 in.

1120mm/ 44 in.

1610mm/ 63 in.



€ 2599

SPÉCIFICATIONS

MOTEUR: MONO CYLINDRE
4 TEMPS 155cc ZONGSHEN/ 4 VITESSES (N1234)
FOURCHE INVERSÉE 735mm
SUSPENSION ARRIÈRE RÉGLABLE 310mm
PNEUS AV. & AR.: 100/90/12 - 120/80/12

SPECIFICATIONS

ENGINE TYPE: SINGLE CYLINDER
4 STROKE ZONGSHEN 155cc/ 4 GEARS (N1234)
735mm UPSD FORK
310mm ADJUSTABLE REAR SUSPENSION
FRONT & REAR TIRES: 100/90/12 - 120/80/12

2024 SM F155 ADRENALINE RUSH

POINTS FORTS & NOUVEAUTÉS 2024

PNEUS KENDA® K702
MOTEUR ZONGSHEN® W155
ROUES YCF
FILTRE À AIR YCF
FOURCHE RÉGLABLE
POIGNÉE CAOUTCHOUC YCF
TÉ FOURCHE SUPÉRIEUR 3 POSITIONS
CARBURATEUR NIBBI PE24SP
NOUVEAU GUIDON BAS

HIGHLIGHTS & 2024 NEW FEATURES

KENDA® TIRES
ZONGSHEN® ENGINE W155
YCF WHEELS
YCF AIR FILTER
ADJUSTABLE FRONT FORK
YCF GRIPS
UPPER CLAMP 3 POSITIONS BAR MOUNT
NIBBI PE24SP CARBURETOR
NEW LOWER HANDLEBAR

M 155



800mm/ 32 in.

 70Kg/ 154 lbs

L : 740mm/ W: 29 in.

1170mm/ 46 in.

1680mm/ 66 in.



€ 3599

SPÉCIFICATIONS

MOTEUR: MONO CYLINDRE 4T, 4 SOUPAPES 190cc
DAYTONA® ANIMA® / 4 VITESSES (N1234)
FOURCHE ENGI® INVERSÉE RÉGLABLE 735mm
SUSPENSION ARRIÈRE DNM® RÉGLABLE 310mm
PNEUS AV. & AR. 100/90/12 - 120/80/12
CARBURATEUR NIBBI® PE28

SPECIFICATIONS

ENGINE TYPE: DAYTONA® ANIMA® SINGLE CYLINDER 4V
 4 STROKE 190cc/ 4 GEARS (N1234)
 735mm ENGI® UPSD ADJUSTABLE FORK
 310mm DNM® ADJUSTABLE REAR SUSPENSION
 FRONT & REAR TIRES: 100/90/12 - 120/80/12
 NIBBI® PE28 CARBURETOR

DAYTONA ENGI® KENDA

2024 SM F190 CATCH ME IF YOU CAN (ON ROAD)

POINTS FORTS & NOUVEAUTÉS 2024

ROUES YCF
PNEUS KENDA® K702
LIGNE D'ÉCHAPPEMENT RACING DOUBLE SORTIE
AMORTISSEUR DNM 1000LBS
MAÎTRE CYLINDRE AVANT RACING
KIT FREIN RADIAL AVANT ET ARRIÈRE
DISQUE FLOTTANT 220MM
TÉ FOURCHE SUPÉRIEUR 3 POSITIONS
NOUVEAU GUIDON BAS

HIGHLIGHTS & 2024 NEW FEATURES

YCF WHEELS
 KENDA® TIRE K702
 COMPLETE RACING EXHAUST TWIN
 DNM SHOCK ABSORBER 1000 LBS
 FRONT RACING MASTER CYLINDER
 FRONT AND REAR RADIAL BRAKE KIT
 SEMI FLOATING BRAKE ROTOR 220MM
 UPPER CLAMP 3 POSITIONS BAR MOUNT
 NEW LOWER HANDLEBAR

F190

F190
DAYTONA



820mm/ 32 in.

 79Kg/ 174 lbs

L : 740mm/ W: 29 in.

1160mm/ 45 in.

1640mm/ 64 in.



€ 3599

2024 GP 107A WARM-UP

SPÉCIFICATIONS

MOTEUR:
MONO CYLINDRE 4T AUTOMATIQUE , ZONGSHEN® 110cc
FOURCHE INVERSÉE YCF® NON RÉGLABLE 650MM
AMORTISSEUR YCF® RÉGLABLE DÉTENTE 310MM
PNEUS AV & AR 100/90/12 - 120/80/12
ROUES YCF® ALUMINIUM AV & AR 2.15/12 & 2.75/12
TÉ DE FOURCHE 160MM
CARBURATEUR NIBBI® PZ18

SPECIFICATIONS

ENGINE TYPE :
ZONGSHEN® AUTOMATIC 110cc
YCF® 650MM NON ADJUSTABLE FRONT FORK
310MM YCF® ADJUSTABLE REBOUND SHOCK ABSORBER
TIRES FRONT & REAR 100/90-12 & 120/80/12
YCF® ALUMINIUM WHEEL 2.15/12 FRONT & 2.75/12 REAR
160MM TRIPLE CLAMP
CARBURETOR NIBBI® PZ18

POINTS FORTS & NOUVEAUTÉS 2024

CADRE ALUMINIUM
BOUCLE ARRIÈRE ALUMINIUM
BRAS OSCILLANT ALUMINIUM
DISQUE FREIN AVANT FLOTTANT 220MM
ÉTRIER FREIN AVANT RADIAL 4 PISTONS
CARÉNAGE SOUPLE
COMMANDES RECLÉES RÉGLABLES
GUIDON BRACELET RÉGLABLE
DIABOLOS DE BÉQUILLE AVANT & ARRIÈRE
TENDEURS DE CHAÎNE MINI GP
BOUCHON RÉSERVOIR ALUMINIUM FERMETURE RAPIDE
ÉCHAPPEMENT BAS
SABOT RÉCUPÉRATEUR D'HUILE ÉTANCHE
LIVRÉ AVEC UNE BÉQUILLE DE STAND

HIGHLIGHTS & 2024 NEW FEATURES

ALUMINIUM FRAME
ALUMINIUM SUBFRAME
ALUMINIUM SWING ARM
220MM FLOATING FRONT DISC
RADIAL 4-PISTON FRONT BRAKE CALIPER
FLEXIBLE FAIRING
FULLY ADJUSTABLE REARSETS
FULLY ADJUSTABLE HANDLEBAR
FRONT & REAR SPOOL
MINI GP BLOCK AXLE
QUICK RELEASE GAS CAP
BELLY EXHAUST SYSTEM
BELLY PAN
INCLUDES BIKE STAND

GP

GP 107^A



715mm/ 28 in.

 72,4Kg/ 158 lbs

L : 690mm/ W: 27 in.

1170mm/ 46 in.

1665mm/ 65 in.



€ 4199

2024 GP 157
APEX

SPÉCIFICATIONS

SPECIFICATIONS

MOTEUR: MONO CYLINDRE 4T, ZONGSHEN® 155cc
MONO CYLINDRE 4T, 4 VITESSES (N1234)
FOURCHE INVERSÉE YCF® RÉGLABLE
COMPRESSION/ DÉTENTE 650MM
AMORTISSEUR YCF FACTORY® RÉGLABLE
DÉTENTE 310MM
PNEUS AV & AR 100/90/12 - 120/80/12
ROUES YCF® ALUMINIUM AV & AR 2.15/12 & 2.75/12
TÉ DE FOURCHE 160MM
CARBURETEUR NIBBI® PE24

ENGINE TYPE : ZONGSHEN® 155cc
 4 SPEED (N1234)
 YCF® 650MM FULLY ADJUSTABLE COMPRESSION/
 REBOUND FRONT FORK
 310MM YCF® FACTORY ADJUSTABLE REBOUND SHOCK
 ABSORBER
 TIRES FRONT & REAR 100/90-12 & 120/80/12
 YCF® ALUMINIUM WHEEL 2.15/12 FRONT & 2.75/12 REAR
 160MM TRIPLE CLAMP
 CARBURETOR NIBBI® PE24

POINTS FORTS & NOUVEAUTÉS 2024

HIGHLIGHTS & 2024 NEW FEATURES

CADRE ALUMINIUM
BOUCLE ARRIÈRE ALUMINIUM
BRAS OSCILLANT ALUMINIUM
DISQUE FREIN AVANT FLOTTANT 220MM
ÉTRIER FREIN AVANT RADIAL 4 PISTONS
CARÉNAGE SOUPLE
COMMANDES REÇULÉES RÉGLABLES
GUIDON BRACELET RÉGLABLE
DIABOLOS DE BÉQUILLE AVANT & ARRIÈRE
TENDEURS DE CHAÎNE MINI GP
BOUCHON RÉSERVOIR ALUMINIUM FERMETURE RAPIDE
ÉCHAPPEMENT BAS
SABOT RÉCUPERATEUR D'HUILE ÉTANCHE
LIVRÉ AVEC UNE BÉQUILLE DE STAND

ALUMINIUM FRAME
 ALUMINIUM SUBFRAME
 ALUMINIUM SWING ARM
 220MM FLOATING FRONT DISC
 RADIAL 4-PISTON FRONT BRAKE CALIPER
 FLEXIBLE FAIRING
 FULLY ADJUSTABLE REARSETS
 FULLY ADJUSTABLE HANDLEBAR
 FRONT & REAR SPOOL
 MINI GP BLOCK AXLE
 QUICK RELEASE GAS CAP
 BELLY EXHAUST SYSTEM
 BELLY PAN
 INCLUDES BIKE STAND

GP

GP157



715mm/ 28 in.

 75Kg/ 165 lbs

L : 690mm/ W: 27 in.

1170mm/ 46 in.

1665mm/ 65 in.



€ 4999

SPÉCIFICATIONS

MOTEUR: DAYTONA® ANIMA/ 4 VITESSES (N1234)
MONO CYLINDRE 4T, 4 SOUPAPES 190cc
**FOURCHE INVERSÉE YCF® RÉGLABLE COMPRESSION/
DÉTENTE 650MM**
**AMORTISSEUR DNM® RÉGLABLE COMPRESSION/
DÉTENTE 310MM**
PNEUS AV & AR 100/90/12 - 120/80/12
ROUES YCF® ALUMINIUM AV & AR 2.15/12 & 2.75/12
TÉ DE FOURCHE 160MM
CARBURATEUR NIBBI® PE28

SPECIFICATIONS

ENGINE TYPE : DAYTONA® ANIMA SINGLE CYLINDER 4V
4 STROKE 190cc/ 4 SPEED (N1234)
YCF® 650MM FULLY ADJUSTABLE COMPRESSION/
REBOUND FRONT FORK
310MM DNM® ADJUSTABLE COMPRESSION/
REBOUND SHOCK ABSORBER
TIRES FRONT & REAR 100/90-12 & 120/80/12
YCF® ALUMINIUM WHEEL 2.15/12 FRONT & 2.75/12 REAR
160MM TRIPLE CLAMP
CARBURETOR NIBBI® PE28

2024 GP 187 HOLESHOT

POINTS FORTS & NOUVEAUTÉS 2024

CADRE ALUMINIUM
BOUCLE ARRIÈRE ALUMINIUM
BRAS OSCILLANT ALUMINIUM
DISQUE FREIN AVANT FLOTTANT 220MM
ÉTRIER FREIN AVANT RADIAL 4 PISTONS
CARÉNAGE SOUPLE
COMMANDES RECLUÉES RÉGLABLES
GUIDON BRACELET RÉGLABLE
DIABOLOS DE BÉQUILLE AVANT & ARRIÈRE
TENDEURS DE CHAÎNE MINI GP
BOUCHON RÉSERVOIR ALUMINIUM FERMETURE RAPIDE
ÉCHAPPEMENT BAS
SABOT RÉCUPÉRATEUR D'HUILE ÉTANCHE
LIVRÉ AVEC UNE BÉQUILLE DE STAND

HIGHLIGHTS & 2024 NEW FEATURES

ALUMINIUM FRAME
ALUMINIUM SUBFRAME
ALUMINIUM SWING ARM
220MM FLOATING FRONT DISC
RADIAL 4-PISTON FRONT BRAKE CALIPER
FLEXIBLE FAIRING
FULLY ADJUSTABLE REARSETS
FULLY ADJUSTABLE HANDLEBAR
FRONT & REAR SPOOL
MINI GP BLOCK AXLE
QUICK RELEASE GAS CAP
BELLY EXHAUST SYSTEM
BELLY PAN
INCLUDES BIKE STAND

GP

GP187 DAYTONA®



715mm/ 28 in.

 76,2Kg/ 167 lbs

L : 690mm/ W: 27 in.

1170mm/ 46 in.

1665mm/ 65 in.



GP PLASTIQUES
YCF PLASTICS



PROTECTION AVANT
 FRONT GUARD

N° YC110-1445-BKM

€ 39



CARÉNAGE GAUCHE
 LEFT SIDE FAIRING

N° YC110-1433-02-BKM
 N° YC110-1433-02-WH

€ 49
 € 49



CARÉNAGE DROIT
 RIGHT SIDE FAIRING

N° YC110-1432-02-BKM
 N° YC110-1432-02-WH

€ 49
 € 49



GARDE BOUE AVANT
 FRONT FENDER

N° YC110-0302-01-BKM
 N° YC110-0302-01-WH

€ 39
 € 39

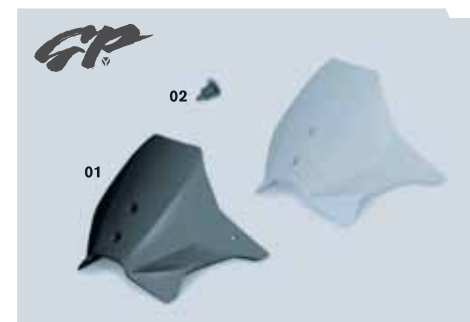

CARÉNAGE AVANT
 FRONT FAIRING

01 N° YC110-0212-13-BKM € 59
 01 N° YC110-0212-13-WH € 59
 02 N° YC110-0941(VIS PLASTIQUE/ PLASTIC SCREW) € 6



COUVRE RÉSERVOIR
 GAS TANK COVER

N° YC110-1402-06-BKM € 79
 N° YC110-1402-06-WH € 79



GARDE BOUE ARIÈRE
 REAR FENDER

N° YC110-0460-02-BKM

€ 39

GP PIÈCES MOTEUR GP ENGINE PARTS



COQUE ARRIÈRE NOIRE, BLANCHE, ORANGE, JAUNE, VERTE
REAR SEAT BLACK, WHITE, ORANGE, YELLOW, GREEN

N° YC110-1402-07-BKM
N° YC110-1402-07-WH
N° YC110-1402-07-OR
N° YC110-1402-07-YE
N° YC110-1402-07-GR

€ 79



SUPPORT DE CARÈNAGE
FAIRING SUPPORT

N° YC110-1444-BKM

€ 69



SUPPORT TÊTE DE FOURCHE
STEEL FRONT FAIRING SUPPORT MATT BLACK

N° YC110-0738-BKM

€ 59



SELLE
SEAT PAD FOAM MATTE BLACK

N° YC110-1401-20-BKM

€ 15



PASSAGE DE ROUE
REAR UNDERTAIL

N° YC110-1402-08-BKM

€ 39



SABOT MOTEUR
BELLY PAN

N° YC110-0905-04-BKM

€ 69

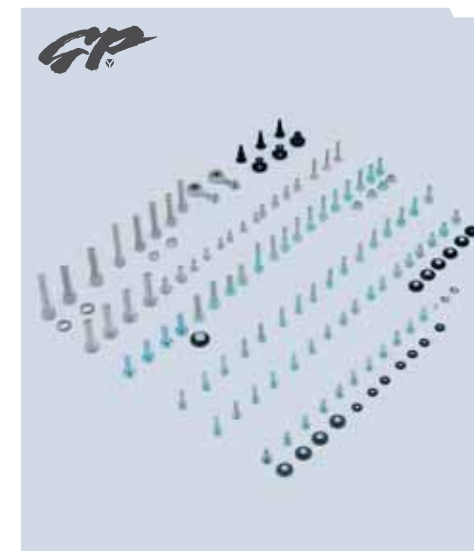

BOÎTE DE VIS GP
GP BOLT SCREW KIT

N° KVP-7

€ 59

PIÈCES GP GP PARTS



TUBE DE GUIDON
CLIP-ON BAR

01 N° YC110-0101-2501-BKM €19
02 N° YC110-0153-02-BKM (EMBOU DE GUIDON) €15



POIGNÉES CAOUTCHOUC GP
GP RUBBER GRIPS

N° PPC012-BK € 12

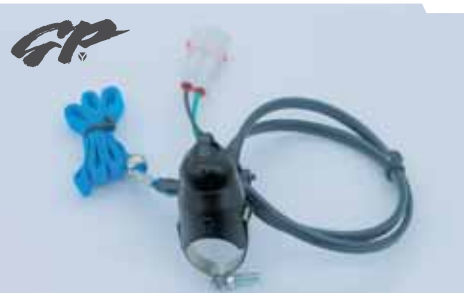

COUPE CIRCUIT AIMANTÉ
MAGNET KILL SWITCH

01 N° YC110-0105-07 (GP187) € 29
02 N° YC110-0105-08 (GP107-GP157) € 29

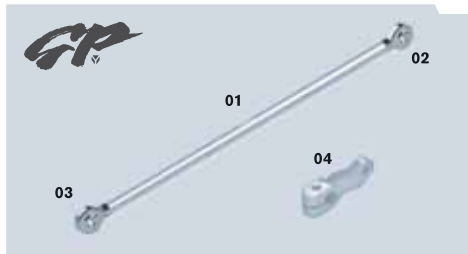

TIGE DE SELECTEUR COMPLET
COMPLETE SHIFT LINKAGE

01 N° YC110-0931-ZH-SI € 12
02 N° YC110-0939-01 € 12
03 N° YC110-0939-02 € 12
04 N° YC110-0932-SI € 19



PÉDALE DE FREIN ALUMINIUM
ALUMINUM BRAKE PEDAL

N° YC110-0938-SI € 49



**JEU DE FOURCHE NON RÉGLABLE L=650mm
POUR GP107 ET RÉGLABLE COMPRESSION/DÉTENTE
L=650mm POUR GP157/ GP187**

PAIR OF FORK L: 650MM NOT ADJUSTABLE TITANIUM FOR GP107 & FORK L: 650MM ADJUSTABLE COMPRESSION / REBOUND TITANIUM FOR GP157 / GP187

01 N° YC110-0400-45-TI (GP107) € 399
02 N° YC110-0400-44-TI (GP157-GP187) € 599

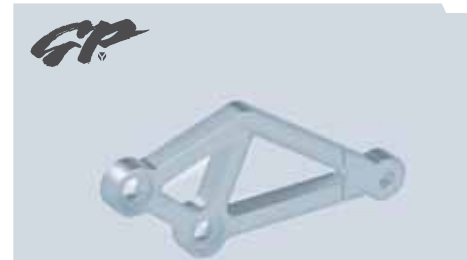

PLATINE ALUMINIUM DE REPOSE PIED GAUCHE
LEFT ALUMINUM FOOTPEG SUPPORT

N° YC110-0933-SI € 39



PÉDALE DE SÉLECTEUR ALUMINIUM
ALUMINUM GEARSHIFT PEDAL

N° YC110-0934-SI € 49

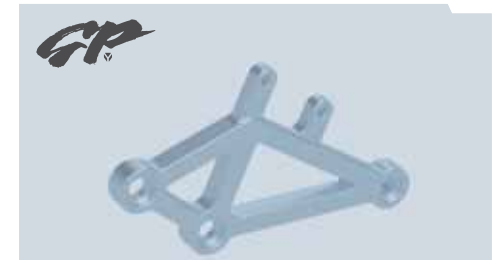

PLATINE ALUMINIUM DE REPOSE PIED DROIT
RIGHT ALUMINUM FOOTPEG SUPPORT

N° YC110-0935-SI € 49

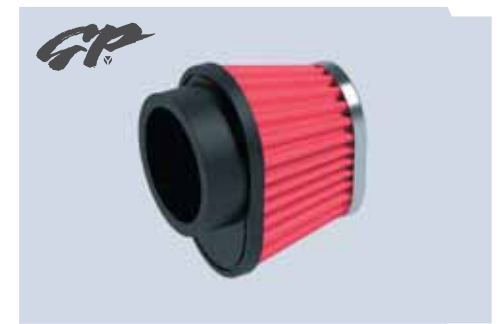

FILTRE À AIR
AIR FILTER

N° KL-ZT-HP-55 € 29



BOUCHON RÉSERVOIR RAPIDE COMPLET
ALUMINIUM QUICK RELEASE GAS CAP

N° YC110-0721 € 89



RÉSERVOIR
GAS TANK

N° YC110-0701-08 € 69



ÉCHAPEMENT COMPLET

COMPLETE MINIGP SINGLE RACING MUFFLER & EXHAUST FOR GP107/ GP157/ GP187

N° YC110-139-15 (GP 107) € 219
 N° YC110-139-14 (GP 157) € 219
 N° YC110-139-13 (GP 187) € 219



KIT FREIN AVANT RADIAL 2 PISTONS L: 775MM
 RADIAL FRONT BRAKE ASSY 2 PUMPS L: 775MM

01 N° YC110-0512-10 € 169
 02 N° YC110-0506-01 € 17



KIT FREIN ARRIÈRE D10/10 L: 365mm
 REAR BRAKE ASSY D10/10 L: 365MM

01 N° YC110-1212-10 € 99
 02 N° YC110-1204-02 € 17



FREIN ARRIÈRE AU GUIDON GP
 REAR BRAKE HANDLE BAR GP

N° YC110-12012-34 € 89



GUIDE CHAÎNE
 CHAIN GUIDE ASSEMBLY

N° YC110-1004-01 € 45



JEUX DE TENDEURS DE CHAÎNE
 AXLE BLOCK ADJUSTER

N° YC110-1021-MG € 59



REPOSES PIEDS ALUMINIUM
 ALUMINUM FOOTPEGS KIT

N° YC110-0902-18-SI € 69



EMBOUIT TÉFLON DE REPOSE PIED
 MINI GP FOOT PEG SLIDER

N° YC110-1037-BK € 9



DIABOLO TEFLON
 SPOOL TEFLON MATT BLACK

N° YC110-1035-02-BK € 13



EMBOUIT DE TÉFLON DE SÉLECTEUR/ PÉDALE DE FREIN
 POM GEARSHIFT END CAP/ BRAKE FOOTPEG

N° YC110-0903-11 € 15

PIÈCES RACING GP GP RACING PARTS



BÉQUILLE AVANT/ ARRIÈRE
FRONT/ REAR STAND

N° STAND1MOTO-04

€ 59



T-SHIRT GP (TAILLE: S/ M/ L/ XL/ XXL)
GP T-SHIRT (SIZE: S/ M/ L/ XL/ XXL)

N° TSGPBK+TAILLE/SIZE
N° TSFGPBK+TAILLE/SIZE (S/ M FEMME/ WOMEN)

€ 19
€ 19



PAIRE DE COUVERTURE CHAUFFANTE AVEC BOITIER DE REGLAGE INDEPENDANT JUSQU'À 99 DEGRES
TIRE WARMERS WITH INDEPENDENT ADJUSTABLE TEMPERATURE CONTROL (UP TO 99 DEGREES)

N° YC110-1125-01-BK

€ 299





**PADDOCK
PADDOCK**



ORIFLAMME
FLAG

N° YCF-FLAG-3M (3 METERS-118 in.)

€ 129

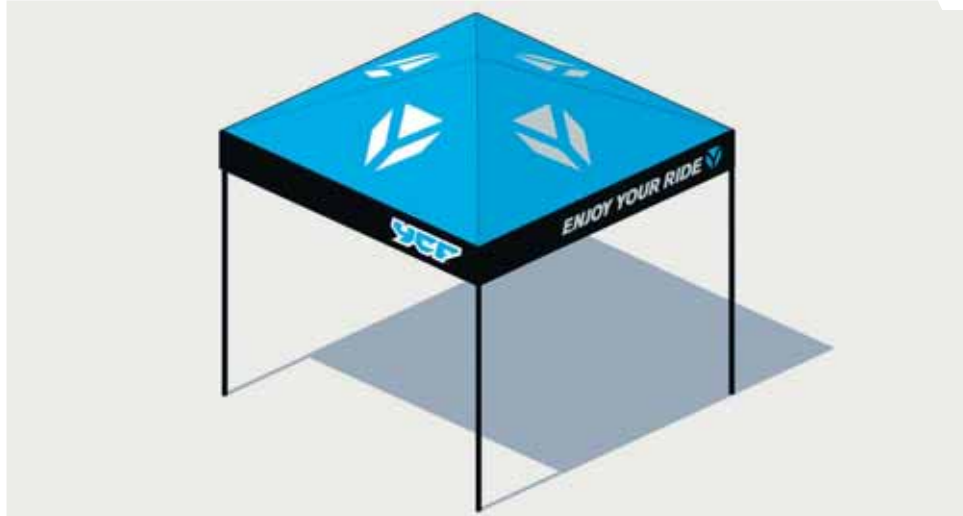

TONNELLE 3 X 3M YCF (100% ÉTANCHE) VELCRO INTÉGRAL AUTOUR DU TOIT
YCF PIT TENT 3 X 3M (100% WATERPROOF) INTEGRAL VELCRO AROUND THE ROOF

N° TONNELLEYCF-4

€ 219



RUBALISE DE TERRAIN (ROULEAU DE 100 MÈTRES)
BANNER ROLL (100 METERS ROLL)

N° RUB-1

€ 15



BANDEROLE DE TERRAIN EN FEUTRINE 1 X 25M
BANNER ROLL 1 X 25M

N° FEUTRINE-2

€ 99



BANNER YCF 2 X 0,50M
YCF BANNER 2 X 0,50M

N° BANNER-01

€ 29



BÂCHE MOTO
MOTORCYCLE COVER

N° BIKECOVER-BL

€ 29

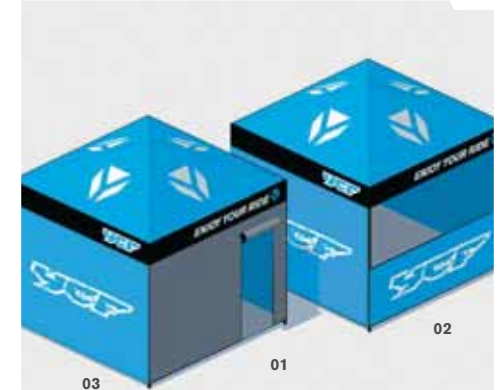

CÔTÉ DE TONNELLE 3 X 3M AVEC PORTE ZIPPÉE
PIT TENT SIDE 3 X 3M WITH ZIP DOOR

01 N° PORTE-1

€ 59

DEMI CÔTÉ DE TONNELLE
PIT TENT HALF SIDE

02 N° DEMICOTE-1-BL

€ 39

CÔTÉ DE TONNELLE 3 X 3M
PIT TENT SIDE 3 X 3M

03 N° COTE-1-BL

€ 49



CHAISE PLIABLE YCF
YCF FOLDING CHAIR

N° CHAIR-BK

€ 29



TRÉPIED ALUMINIUM NOIR/ BLEU/ VERT/ ORANGE/ ROUGE - HAUTEUR 40 cm
ALUMINUM BIKE STAND BLACK/ BLUE/ GREEN/ ORANGE/ RED - HEIGHT 15,7 in.

BÉQUILLE ROUE AR RÉGLABLE AVEC ROULETTE
REAR STAND. COMES WITH HEIGHT ADJUSTABLE FORKS FOR SPOOLS

N° TREPIED-COLOR € 109

N° STAND1MOTO-04 € 59



TAPIS SOL ENVIRONNEMENTAL YCF 180X80 CM
ENVIRONMENTAL YCF RUBBER MAT 180X80 CM (70in x 31 in.)

TRÉPIED ACIER NOIR pour 50/88 - HAUTEUR 32 cm
50/88 STEEL BIKE STAND BLACK - HEIGHT 12 in.

TRÉPIED ACIER NOIR - HAUTEUR 40 cm
STEEL BIKE STAND BLACK - HEIGHT 15,7 in.

BÉQUILLE ROUE AR RÉGLABLE
ADJUSTABLE REAR WHEEL STAND

N° TAPISSOL-4 € 89

N° TREPIED02-BK € 69

N° TREPIED01-BK € 69

N° STAND1MOTO-02 € 39

**TEXTILES
APPAREL**



PARAPLUIE YCF
YCF UMBRELLA

N° UMBRELLA

€ 29



BONNET YCF
YCF BEANIE

N° BYCF01-BK

€ 15

**NEW
2024**



BENT CASQUETTE YCF
YCF CURVED BILL HAT

N° CYCF05-BK

€ 20

**NEW
2024**



CASQUETTE BASEBALL YCF
YCF SNAPBACK HAT

N° CYCF05-BL

€ 20

**NEW
2024**



SWEAT À CAPUCHE ZIPPÉ YCF (S/ M/ L/ XL/ XXL)
YCF ZIP HOODIE (SIZE: S/ M/ L/ XL/ XXL)

N° SWEAT04BL+TAILLE/SIZE

€ 59



POLO RACING YCF (S/ M/ L/ XL/ XXL)
YCF SHORT SLEEVE POLO (S/ M/ L/ XL/ XXL)

N° POLOYCF01BL+TAILLE/SIZE

€ 35

**NEW
2024**



T-SHIRT YCF (TAILLE: S/ M/ L/ XL/ XXL)
YCF T-SHIRT (SIZE: S/ M/ L/ XL/ XXL)

N° TSYCFBK02+TAILLE/SIZE

€ 19

N° TSYCFBK02+TAILLE/SIZE (XS/ S/ M FEMME/ WOMEN)



T-SHIRT ENFANT YCF (TAILLE: 4 ANS/ 8 ANS)
YCF YOUTH T-SHIRT (SIZE: 4 YEARS/ 8 YEARS)

N° TSK02BL-4 (4 YEARS)
N° TSK02BL-8 (8 YEARS)

€ 19



CHAPEAU YCF
YCF STRAW HAT

N° STHYCF

€ 29



SAC À DOS YCF
YCF BACKPACK

N° BACKPACKYCF-GY

€ 49



SAC DE TRANSPORT 54X32X32cm
DUFFLE BAG 54X32X32cm

N° BAGYCF-BL

€ 49

GRAPHICS & PLASTICS



TM

ACCESSOIRES PLASTIQUES

KITS DÉCO/ GRAPHIC KITS	62
PERSONNALISATION/ CUSTOMIZATION	67
KITS PLASTIQUES/ PLASTIC KITS	68

RACING KITS DÉCO/ GRAPHIC KITS



⚠ KIT COMPLET POUR GAMME 2007 À 2024
COMPLETE KIT FOR RANGE 2007 TO 2024



KIT DÉCO RACING JAUNE/ NOIR pour LITE/ START/ PILOT/ FACTORY/ SM
GRAPHICS KIT RACING YELLOW/ BLACK for LITE/ START/ PILOT/ FACTORY/ SM

N° KD-AFT22-BK

€ 79



KIT DÉCO RACING VERT/ ROUGE pour LITE/ START/ PILOT/ FACTORY/ SM
GRAPHICS KIT RACING GREEN/ RED for LITE/ START/ PILOT/ FACTORY/ SM

N° KD-AFT22-GR

€ 79



KIT DÉCO DE CADRE POUR FACTORY
GRAPHIC KIT FOR FACTORY FRAME

N° FGKFP-BK

€ 19



KIT DÉCO RACING BLEU/ BLANC pour LITE/ START/ PILOT/ FACTORY/ SM
GRAPHICS KIT RACING BLUE/ WHITE for LITE/ START/ PILOT/ FACTORY/ SM

N° KD-AFT22-BL

€ 79



KIT DÉCO RACING ROUGE/ BLEU pour LITE/ START/ PILOT/ FACTORY/ SM
GRAPHICS KIT RACING RED/ BLUE for LITE/ START/ PILOT/ FACTORY/ SM

N° KD-AFT22-RD

€ 75



KIT DÉCO DE CADRE POUR PILOT
GRAPHIC KIT FOR PILOT FRAME

N° FGKP-BK

€ 16

**NEW
2024**



ORIGINAL YCF® KITS DÉCO/ GRAPHIC KITS



KIT DÉCO 50 YCF 2024
50 YCF GRAPHIC KIT 2024

N° KD50A2024 (50 SEULEMENT/ ONLY) € 59



KIT DÉCO START 88SE 2024
GRAPHIC KIT START 88SE 2024

N° KD88SE2024 € 59



KIT DÉCO START 125 2024
GRAPHIC KIT START 125 2024

N° KD1252024 € 59



KIT DÉCO START 125SE 2024
GRAPHIC KIT START 125SE 2024

N° KD125SE2024 € 59



KIT DÉCO LITE 88 2024
GRAPHIC KIT LITE 88 2024

N° KD88L2024 € 59



KIT DÉCO LITE 125 2024
GRAPHIC KIT LITE 125 2024

N° KD125L2024 € 59





KIT DÉCO PILOT 125 2024
GRAPHIC KIT PILOT 125 2024

Nº KDP1252024

€ 69



KIT DÉCO PILOT 150E 2024
GRAPHIC KIT PILOT 150E 2024

Nº KDP150E2024

€ 69



KIT DÉCO SM 125 2024
GRAPHIC KIT SM 125 2024

Nº KDSM1252024

€ 59



KIT DÉCO FACTORY SP2 2024
GRAPHIC KIT FACTORY SP2 2024

Nº KDSP22024

€ 69



KIT DÉCO FACTORY SP3 190 2024
GRAPHIC KIT FACTORY SP3 190 2024

Nº KDSP31902024

€ 69



KIT DÉCO SM 155 2024
GRAPHIC KIT SM 155 2024

Nº KDSM1552024

€ 69



KIT DÉCO SM 190 2024
GRAPHIC KIT SM 190 2024

Nº KDSM1902024

€ 69

**NEW
2024**



ORIGINAL YCF® KITS DÉCO/ GRAPHIC KITS



KIT DÉCO BIGY 125 MX 2024
GRAPHICS KIT BIGY 125 MX 2024

N° KDBIGY12524

€ 89



KIT DÉCO BIGY 150 MX 2024
GRAPHICS KIT BIGY 150 MX 2024

N° KDBIGY15024

€ 89



KIT DÉCO BIGY FACTORY 150 MX-E 2024
GRAPHICS KIT BIGY FACTORY 150 MX-E 2024

N° KDBIGYF150E024

€ 89



KIT DÉCO BIGY FACTORY 190 MX DAYTONA® 2024
GRAPHICS KIT BIGY FACTORY 190 MX DAYTONA® 2024

N° KDBIGYFD19024

€ 89



KIT DÉCO RACING JAUNE/ NOIR pour BIGY
 GRAPHICS KIT RACING YELLOW/ BLACK for BIGY

N° KDBIGY-AFT22-BK

€ 99



KIT DÉCO RACING VERT/ ROUGE pour BIGY
 GRAPHICS KIT RACING GREEN/ RED for BIGY

N° KDBIGY-AFT22-GR

€ 99



KIT DÉCO RACING BLEU/ BLANC pour BIGY
 GRAPHICS KIT RACING BLUE/ WHITE for BIGY

N° KDBIGY-AFT22-BL

€ 99



KIT DÉCO RACING ROUGE/ BLEU pour BIGY
 GRAPHICS KIT RACING RED/ BLUE for BIGY

N° KDBIGY-AFT22-RD

€ 99

PERSONNALISATION CUSTOMIZATION

31 968 COMBINAISONS

2 COULEURS DE PLAQUES (PLASTIQUE)
8 COULEURS DE FONDS DE PLAQUES
999 CHIFFRES (DESIGN YCF)
2 COULEURS DE CHIFFRES

YCF ID 1.0 EST LA 1^{ÈRE} ÉTAPE DU PROGRAMME DE PERSONNALISATION DE VOTRE MOTO YCF, VOUS POUVEZ MAINTENANT CRÉER VOTRE PLAQUE NUMÉRO ORIGINALE GRÂCE À UN LARGE CHOIX DE DESIGNS GRAPHIQUES ET DE COULEURS.

DISPONIBLE CHEZ VOTRE REVENDEUR.

31,968 COMBINATIONS

2 (PLASTIC) PLATE COLORS
8 BACKGROUND PLATE COLORS
999 INDIVIDUAL CHARACTERS (YCF DESIGN)
2 COLORS AVAILABLE

YCF ID 1.0 IS THE FIRST STAGE OF THE CUSTOMIZATION PROCESS FOR YOUR YCF MINI-BIKE. YOU CAN NOW CREATE YOUR OWN ORIGINAL NUMBER PLATE THANKS TO A WIDE CHOICE OF GRAPHIC DESIGNS AND COLOR.

AVAILABLE AT YOUR RETAILER.

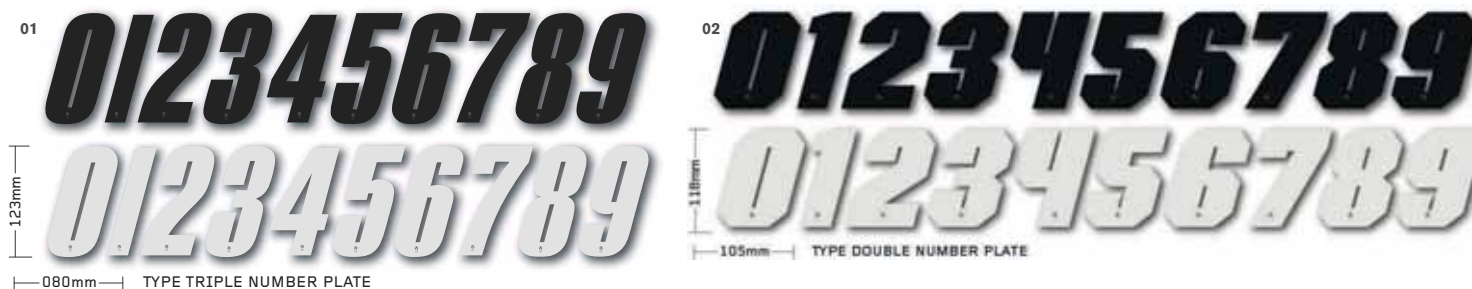

NUMÉRO POUR 3 PAR PLAQUE
NUMBERS FOR 3 PER PLATE

01 N° NUM.NUMER/8CM (NOIR/ BLACK) (x3) € 7
01 N° NUMW. NUMER/8CM (BLANC/ WHITE)

NUMÉRO POUR 2 PAR PLAQUE
NUMBERS FOR 2 PER PLATE

02 N° NUM.NUMER/11CM (NOIR/ BLACK) (x3) € 8
02 N° NUMW.NUMER/11CM (BLANC/ WHITE)

NUMÉRO POUR 1 PAR PLAQUE
NUMBERS FOR 1 PER PLATE

03 N° NUM.NUMER/18CM (NOIR/ BLACK) (x3) € 9
03 N° NUMW.NUMER/18CM (BLANC/ WHITE)



N° STSVYCF-01

€ 9

KITS PLASTIQUES YCF

YCF PLASTIC KITS



PLAQUE AVANT POUR LITE 88 2020-24/ LITE 125/ START 88SE 2020-24/ START 125/ PILOT/ FACTORY/ SM
NOIRE/ BLEUE/ ROUGE/ VERTE/ JAUNE/ ORANGE/ ROSE/ BLANCHE/ GRISE

FRONT NUMBER PLATE FOR LITE 88 2020-24/ LITE 125/ START 88SE 2020-24/ START 125/ PILOT/ FACTORY/ SM
BLACK/ BLUE/ RED/ GREEN/ YELLOW/ ORANGE/ PINK/ WHITE/ GREY

N° YC110-0212-07-COLOR

€ 19



GARDE BOUE AVANT POUR LITE 125/ START 125/ PILOT/ FACTORY/ SM (2014-2024)/ START 88SE 2021
NOIR/ BLEU/ ROUGE/ VERT/ JAUNE/ ORANGE/ ROSE/ BLANC/ GRIS

FRONT FENDER FOR LITE 125/ START 125/ PILOT/ FACTORY/ SM (2014-2024)/ START 88SE 2021
BLACK/ BLUE/ RED/ GREEN/ YELLOW/ ORANGE/ PINK/ WHITE/ GREY

N° YC110-032-02-COLOR

€ 19



**NEW
2024**



OUIE RADIATEUR DROITE EN 2 PARTIES POUR PILOT 2018-24/ FACTORY 2017-24/ START 2020-24
NOIRE/ BLEUE/ ROUGE/ VERTE/ JAUNE/ ORANGE/ BLANCHE/ GRISE/ ROSE

RIGHT SHROUD 2 PARTS FOR PILOT 2018-24/ FACTORY 2017-24/ START 2020-24
BLACK/ BLUE/ RED/ GREEN/ YELLOW/ ORANGE/ WHITE/ GREY/ PINK

N° YC110-14-059-COLOR

€ 19



**NEW
2024**



OUIE RADIATEUR GAUCHE EN 2 PARTIES POUR PILOT 2018-24/ FACTORY 2017-24/ START 2020-24
NOIRE/ BLEUE/ ROUGE/ VERTE/ JAUNE/ ORANGE/ BLANCHE/ GRISE/ ROSE

LEFT SHROUD 2 PARTS FOR PILOT 2018-24/ FACTORY 2017-24/ START 2020-24
BLACK/ BLUE/ RED/ GREEN/ YELLOW/ ORANGE/ WHITE/ GREY/ PINK

N° YC110-14-069-COLOR

€ 19



PLAQUE LATÉRALE DROITE POUR LITE/ START 2017-2024/ PILOT 2007-2015/ FACTORY 2007-2015
NOIRE/ BLEUE/ ROUGE/ VERTE/ JAUNE/ ORANGE/ ROSE/ BLANCHE/ GRISE
 RIGHT NUMBER PLATE FOR LITE/ START 2017-2024/ PILOT 2007-2015/ FACTORY 2007-2015
 BLACK/ BLUE/ RED/ GREEN/ YELLOW/ ORANGE/ PINK/ WHITE/ GREY

Nº YC110-14-022-COLOR

€ 15



PLAQUE LATÉRALE GAUCHE POUR LITE/ START 2017-2024/ PILOT 2007-2015/ FACTORY 2007-2015
NOIRE/ BLEUE/ ROUGE/ VERTE/ JAUNE/ ORANGE/ ROSE/ BLANCHE/ GRISE
 LEFT NUMBER PLATE FOR LITE/ START 2017-2024/ PILOT 2007-2015/ FACTORY 2007-2015
 BLACK/ BLUE/ RED/ GREEN/ YELLOW/ ORANGE/ PINK/ WHITE/ GREY

Nº YC110-14-042-COLOR

€ 15



PLAQUE LATÉRALE DROITE POUR PILOT 2016-24/ FACTORY 2016-24
NOIRE/ BLEUE/ ROUGE/ VERTE/ JAUNE/ ORANGE/ BLANCHE/ GRISE/ ROSE
 RIGHT NUMBER PLATE FOR PILOT 2016-24/ FACTORY 2016-24
 BLACK/ BLUE/ RED/ GREEN/ YELLOW/ ORANGE/ WHITE/ GREY/ PINK

Nº YC110-14-028-COLOR

€ 15



PLAQUE LATÉRALE GAUCHE POUR PILOT 2016-24/ FACTORY 2016-24
NOIRE/ BLEUE/ ROUGE/ VERTE/ JAUNE/ ORANGE/ BLANCHE/ GRISE/ ROSE
 LEFT NUMBER PLATE FOR PILOT 2016-24/ FACTORY 2016-24
 BLACK/ BLUE/ RED/ GREEN/ YELLOW/ ORANGE/ WHITE/ GREY/ PINK

Nº YC110-14-048-COLOR

€ 15



GARDE BOUE ARRIÈRE POUR LITE/ START 2007-2024/ PILOT 2007-2015/ FACTORY 2007-2015
NOIR/ BLEU/ ROUGE/ VERT/ JAUNE/ ORANGE/ ROSE/ BLANC/ GRIS

REAR FENDER FOR LITE/ START 2007-2024/ PILOT 2007-2015/ FACTORY 2007-2015
 BLACK/ BLUE/ RED/ GREEN/ YELLOW/ ORANGE/ PINK/ WHITE/ GREY

N° YC110-14-012-COLOR

€ 15



**NEW
2024**

PAIRE DE PROTECTIONS FOURCHE (ADAPTABLE SUR TOUTES LES FOURCHES)
NOIRES/ BLEUES/ ROUGES/ VERTES/ JAUNES/ ORANGES/ BLANCHES/ ROSE

PAIR OF FORK GUARD (WITH SLOTTED HOLE ADAPTABLE TO ALL FORKS)
 BLACK/ BLUE/ RED/ GREEN/ YELLOW/ ORANGE/ WHITE/ PINK

N° PFYCF12-COLOR (735mm)
 N° YC110-0418-01WH (BLANC/ WHITE - 660mm)
 N° YC110-0418-01BK (NOIR/ BLACK - 660mm)

€ 30
 € 30
 € 30



**NEW
2024**

GARDE BOUE ARRIÈRE POUR PILOT 2016-24/ FACTORY 2016-24
NOIR/ BLEU/ ROUGE/ VERT/ JAUNE/ ORANGE/ BLANC/ GRIS/ ROSE

REAR FENDER FOR PILOT 2016-24/ FACTORY 2016-24
 BLACK/ BLUE/ RED/ GREEN/ YELLOW/ ORANGE/ WHITE/ GREY/ PINK

N° YC110-14-018-COLOR

€ 15



FOR 50 ONLY



PAIRE DE PROTECTIONS FOURCHE POUR YCF 50 BLEU/ ROUGE/ VERT/ JAUNE/ ORANGE/ BLANC
 FORK GUARD FOR YCF 50 BLUE/ RED/ GREEN/ YELLOW/ ORANGE/ WHITE

N° YC50-0418-COLOR

€ 19



NEW
2024



GARDE BOUE AVANT YCF NOIR/ BLEU/ BLEU YCF/ ROUGE/ VERT/ JAUNE/ ORANGE/ BLANC/ GRIS/ ROSE
YCF FRONT FENDER BLACK/ BLUE/ YCF BLUE/ RED/ GREEN/ YELLOW/ ORANGE/ WHITE/ GREY/ PINK

N° YC110-032-10-COLOR

€ 19



NEW
2024



GARDE BOUE ARRIÈRE YCF NOIR/ ROUGE/ BLANC/ VERT/ JAUNE/ ORANGE/ BLEU/ GRIS/ ROSE
YCF REAR FENDER BLACK/ RED/ WHITE/ GREEN/ YELLOW/ ORANGE/ BLUE/ GREY/ PINK

N° YC110-14-019-COLOR

€ 19



NEW
2024



OUIE RADIATEUR YCF DROITE NOIRE/ BLEUE/ ROUGE/ VERTE/ JAUNE/ ORANGE/ BLANCHE/ GRISE/ ROSE
YCF RIGHT SHROUD BLACK/ BLUE/ RED/ GREEN/ YELLOW/ ORANGE/ WHITE/ GREY/ PINK

N° YC110-1406-COLOR

€ 19



NEW
2024



OUIE RADIATEUR YCF GAUCHE NOIRE/ BLEUE/ ROUGE/ VERTE/ JAUNE/ ORANGE/ BLANCHE/ GRISE/ ROSE
YCF LEFT SHROUD BLACK/ BLUE/ RED/ GREEN/ YELLOW/ ORANGE/ WHITE/ GREY/ PINK

N° YC110-1407-COLOR

€ 19



PLAQUE AVANT YCF NOIR/ BLEU/ BLEU YCF/ ROUGE/ VERT/ JAUNE/ ORANGE/ BLANC/ GRIS
YCF FRONT NUMBER PLATE BLACK/ BLUE/ YCF BLUE/ RED/ GREEN/ YELLOW/ ORANGE/ WHITE/ GREY

N° YC110-0212-09-COLOR

€ 19



PLAQUE LATÉRALE YCF DROITE NOIR/ BLEU/ ROUGE/ VERT/ JAUNE/ ORANGE/ BLANC/ GRIS
YCF RIGHT NUMBER PLATE BLACK/ BLUE/ RED/ GREEN/ YELLOW/ ORANGE/ WHITE/ GREY

N° YC110-14-029-COLOR

€ 19



PLAQUE LATÉRALE YCF GAUCHE NOIR/ BLEU/ ROUGE/ VERT/ JAUNE/ ORANGE/ BLANC/ GRIS
YCF LEFT NUMBER PLATE BLACK/ BLUE/ RED/ GREEN/ YELLOW/ ORANGE/ WHITE/ GREY

N° YC110-14-049-COLOR

€ 19



FOR 50 ONLY



KIT PLASTIQUE YCF 50 NOIR/ BLEU/ ROUGE/ VERT/ JAUNE/ ORANGE/ ROSE/ BLANC/ GRIS
YCF 50 PLASTIC KIT BLACK/ BLUE/ RED/ GREEN/ YELLOW/ ORANGE/ PINK/ WHITE/ GREY

N° KPYCF50-02-COLOR € 69

GARDE BOUE AVANT POUR YCF 50, LITE 88 2020-24, START 88SE 2022-24, SM 2022-24 NOIR/ BLEU/ ROUGE/ VERT/ JAUNE/ ORANGE/ ROSE/ BLANC/ GRIS
FRONT FENDER FOR YCF 50, LITE 88 2020-24, START 88SE 2022-24, SM 2022-24 BLACK/ BLUE/ RED/ GREEN/ YELLOW/ ORANGE/ PINK/ WHITE/ GREY

01 N° YC50-031-01-COLOR € 15
02 N° YC50-0212-03-COLOR PLAQUE AVANT € 17



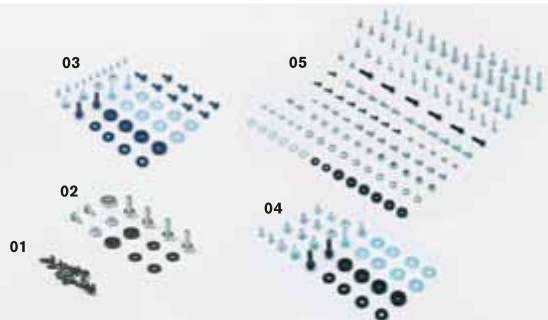

KIT VIS POUR FIXER LES PLASTIQUES SUR LA SELLE
BOLT KIT FOR FIXING THE PLASTICS TO THE SEAT

01 N° KVP € 2

KIT VISSERIE POUR KIT PLASTIQUE (2+2 POUR RÉSERVOIR + 2 POUR SELLE SUR CADRE)
BOLT KIT FOR PLASTIC KIT (2+2 FOR FUEL TANK + 2 FOR SEAT ON FRAME)

02 N° KVP-2 € 3

KIT VISSERIE POUR PLASTIQUE START/ PILOT/ FACTORY
BOLT KIT FOR PLASTIC KIT START/ PILOT/ FACTORY

03 N° KVP-3 € 6

KIT VISSERIE POUR PLASTIQUE BIGY
BOLT KIT FOR PLASTIC KIT BIGY

04 N° KVP-4 € 6

KIT VIS COMPLET YCF
COMPLETE YCF BOLT KIT

05 N° KVP-5 € 39



PROTÈGE DISQUE AVANT NOIR/ BLEU/ ROUGE/ VERT/ JAUNE/ ORANGE/ BLANC
FRONT BRAKE PROTECTION BLACK/ BLUE/ RED/ GREEN/ YELLOW/ ORANGE/ WHITE

N° YC110-0627-COLOR € 35



PASSE DURITE FREIN AVANT CNC NOIR/ BLEU/ ROUGE/ VERT/ ORANGE
ALUMINUM BRAKE LINE RETAINER BLACK/ BLUE/ RED/ GREEN/ ORANGE

N° YC110-0403-06-COLOR € 19



PASSE DURITE YCF
YCF BRAKE LINE RETAINER-PLASTIC

01 N° YC110-0403-05 € 5

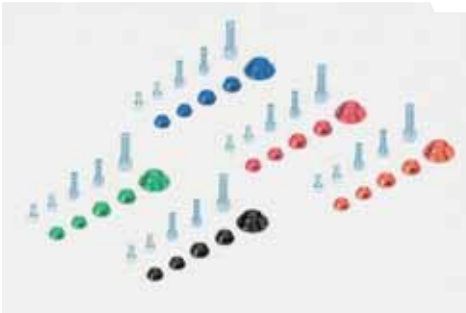

KIT RONDELLE CNC POUR RÉSERVOIR ET KIT PLASTIQUE, VENDU AVEC LES VIS BTR (2XM5/ 2XM6/ 1XM8)
NOIR/ BLEU/ ROUGE/ VERT/ ORANGE
CNC WASHER AND BTR SCREW FOR TANK AND PLASTIC KIT (2XM5/ 2XM6/ 1XM8)
BLACK/ BLUE/ RED/ GREEN/ ORANGE

N° KRV-COLOR € 19



KIT COMPLET PHARES POUR START/ LITE/ FACTORY SP1 & SP2/ BIGY 125 & 150
LIGHT KIT FOR START/ LITE/ FACTORY SP1 & SP2/ BIGY 125 & 150

N° KL1E pour moto avec démarreur électrique/ for electric start bike € 119
N° KL1 € 159
01 N° YC110-1525-02 Bavette arrière/ tail light mud guard € 29



PLAQUE PHARE AVANT YCF NOIRE/ BLANCHE
YCF HEADLIGHT BLACK/ WHITE

N° YC110-1523-02 - COLOR € 59

MOTORCYCLE PARTS

PIÈCES MOTO

GUIDONS/ HANDLEBARS	76
POIGNÉES/ LEVERS	78
FOURCHES/ FORKS	80
CADRES/ FRAMES	83
SELLES/ SEATS	84
RÉSERVOIRS/ FUEL TANKS	85
FREINS/ BRAKES	86
BRAS OSCILLANTS/ SWING ARMS	94
AMORTISSEURS/ SHOCK ABSORBERS	96
ROUES/ WHEELS	97
JANTES & MOYEUX/ RIMS & HUBS	97
PNEUS/ TIRES	104
REPOSE-PIEDS & SABOTS/ FOOT PEGS & SKID PLATES	106
SÉLECTEURS/ SHIFT LEVERS	107
KITS CHÂINES/ SPROCKET KITS	108
OUTILS/ TOOLS	110
ENGI®/ ENGI®	112
PIÈCES SPÉCIALES SUPERMOTARD/ SUPERMOTO FACTORY SPECIAL PARTS	114



GUIDONS HANDLE BARS



MOUSSE GUIDON SANS BARRE
NOIRE/ BLEUE/ ROUGE/ VERTE/ JAUNE/ ORANGE/ ROSE/ BLANCHE
HANDLEBAR PAD WITHOUT CROSSBAR
BLACK/ BLUE/ RED/ GREEN/ YELLOW/ ORANGE/ PINK/ WHITE

N° YC110-01046-COLOR

€ 12



MOUSSE GUIDON CAOUTCHOUC 3D
HANDLEBAR PAD WITH RUBBER COVER 3D

N° YC110-0133-01BK

€ 12



FOR 50 ONLY

MOUSSE GUIDON YCF 50 SANS BARRE
NOIRE/ BLEUE/ ROUGE/ VERTE/ JAUNE/ ORANGE/ ROSE/ BLANCHE
HANDLEBAR PAD YCF 50 WITHOUT CROSSBAR
BLACK/ BLUE/ RED/ GREEN/ YELLOW/ ORANGE/ PINK/ WHITE

N° YC50-0129-COLOR

€ 8



MOUSSE GUIDON NOIRE/ BLEUE/ ROUGE/ VERTE/ JAUNE/ ORANGE/ ROSE/ BLANCHE
HANDLEBAR PAD BLACK/ BLUE/ RED/ GREEN/ YELLOW/ ORANGE/ PINK/ WHITE

N° YC110-0132-COLOR

€ 10



PAIRE DE PROTÈGES MAINS
HANDGUARD

N° YC110-14-070BK (NOIRE/ BLACK)
N° YC110-14-070WH (BLANCHE/ WHITE)

€ 25



PAIRE DE PROTÈGES MAINS ENDURO/SUPERMOTO
(FIXATION POUR GUIDON ACIER/ALU Ø 22,2 ET 28,6)
ENDURO/SUPERMOTO HANDGUARDS
(FIXING KITS FOR STEEL/ALU Ø 22,2 AND 28,6)

N° YC110-14-071BK (NOIRE/ BLACK)
N° YC110-14-071WH (BLANCHE/ WHITE)

€ 69



PROTÈGE LEVIER TYPE MOTOGP
MOTOGP STYLE LEVER PROTECTION

N° YC110-14-072BK

€ 39

FACTORY
SPECIAL PARTS
YCF RACING

Ø 22



GUIDON ALUMINIUM (MOUSSE COMPRISE)
NOIR/ BLEU/ ROUGE/ VERT/ ORANGE
ALUMINUM HANDLEBAR (BAR PAD INCLUDED)
BLACK/ BLUE/ RED/ GREEN/ ORANGE

N° GA-COLOR

€ 45

FACTORY
SPECIAL PARTS
YCF RACING

Ø 22



GUIDON MID SIZE ALUMINIUM (MOUSSE COMPRISE)
NOIR/ BLEU/ ROUGE/ VERT/ ORANGE
ALUMINUM CROSS BAR (BAR PAD INCLUDED)
BLACK/ BLUE/ RED/ GREEN/ ORANGE

N° GALOW-COLOR
N° GALOW-03BK (BIGY)

€ 45
€ 49

FACTORY
SPECIAL PARTS
YCF RACING

SOLO 50A

Ø 28



GUIDON ALUMINIUM SANS BARRE (POUR YCF 50) NOIR/ BLEU/ ROUGE/ VERT/ ORANGE (MOUSSE COMPRISE)
ALUMINUM HANDLEBAR WITHOUT CROSSBAR (FOR YCF 50) BLACK/ BLUE/ RED/ GREEN/ ORANGE (BAR PAD INCLUDED)

01 N° GASB50-COLOR

€ 39

GUIDON ALUMINIUM SANS BARRE BLEU/ NOIR/ ROUGE/ ORANGE/ VERT (MOUSSE COMPRISE)
ALUMINUM HANDLEBAR WITHOUT CROSSBAR BLUE/ BLACK/ RED/ ORANGE/ GREEN (BAR PAD INCLUDED)

02 N° GASB-COLOR

€ 59

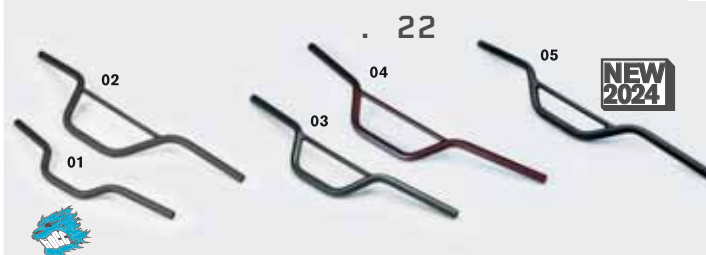

GUIDON ACIER (POUR YCF 50)
STEEL HANDLEBAR (FOR YCF 50)

GUIDON CHROMOLLY 22,2mm
CHROMOLLY HANDLEBAR 22,2mm

01 N° YC50-0101-02 (YCF 50)
02 N° YC110-0101-34-BK (LITE/ START/ PILOT)
03 N° YC110-0101-12 (BAS/ LOW: 665mm)
04 N° YC110-0101-1601-BK (BIGY: 780mm)
05 N° YC110-0101-36-BK (BAS/ LOW: 760mm) SM 2024

€ 15
€ 19
€ 19
€ 19

Ø 28



GUIDON ALUMINIUM RENFORCÉ 28.6 mm
ALUMINUM HANDLEBAR 28.6 mm

N° GA-02BK (FACTORY 760mm)
N° GALOW-04BK (BIGY 780mm)

€ 79
€ 79



POIGNÉES HANDLES



FOR 50 ONLY



01

02

FACTORY
SPECIAL PARTS
YCF RACING

**LEVIER DE FREIN AVANT OU ARRIÈRE PLIABLE POUR YCF 50 2020-24
NOIR/ BLEU/ ROUGE/ VERT/ ORANGE**

FOLDABLE FRONT OR REAR BRAKE LEVER FOR YCF 50 2020-24
BLACK/ BLUE/ RED/ GREEN/ ORANGE

01 N° LFG50-1-COLOR (ARRIÈRE/ REAR)
02 N° LFD50-1-COLOR (AVANT/ FRONT)

€ 39



FACTORY
SPECIAL PARTS
YCF RACING



**LEVIER D'EMBRAYAGE AVEC COCOTTE CNC NOIR/ BLEU/ ROUGE/ VERT
CLUTCH LEVER WITH CNC BRACKET BLACK/ BLUE/ RED/ GREEN**

N° YC110-0103-06-COLOR

€ 99

FACTORY
SPECIAL PARTS
YCF RACING



01

02

**LEVIER DE FREIN OU D'EMBRAYAGE PLIABLE NOIR/ BLEU/ ROUGE/ VERT/ ORANGE
VENDU AVEC LA COCOTTE**

FOLDABLE BRAKE OR CLUTCH LEVER BLACK/ BLUE/ RED/ GREEN/ ORANGE
SOLD WITH BRACKET

01 N° LFP21-COLOR (FREIN/BRAKE) € 39
02 N° LEP21-COLOR (EMBRAYAGE/ CLUTCH) € 39



01

02

**LEVIER FREIN OU EMBRAYAGE REPLIABLE
VENDU AVEC LA COCOTTE**

FOLDABLE BRAKE OR CLUTCH LEVER
SOLD WITH BRACKET

01 N° LEPLIABLE (EMBRAYAGE/ CLUTCH) € 25
02 N° LFPLIABLE (FREIN/ BRAKE) € 25



01

03

02

**POIGNÉE DE GAZ À TIRAGE RAPIDE YCF (VENDU AVEC
LES 2 POIGNÉES)**

YCF QUICK-ACTION THROTTLE TUBE (INCLUDE GRIP)

01 N° YC110-0138-03 € 25

POIGNÉE DE GAZ AVEC RÉGLAGE (VIS DE BRIDAGE)

THROTTLE TUBE WITH ADJUSTMENT SCREW (POWER
CONTROL)

02 N° YC110-0138-04 (Vendu avec les 2 poignées) € 25

VIS M5X50 POUR RÉGLAGE DE LA POIGNÉE DE GAZ

SCREW FOR THROTTLE ADJUSTMENT, SIZE M5X50

03 N° YC110-01022-06 € 3





LEVIER FREIN PLIABLE
FOLDABLE BRAKE LEVER

N° YC110-0517-01

€ 15



LEVIER D'EMBRAYAGE + COCOTTE AVEC MOLETTE RAPIDE (2020-24)
CLUTCH LEVER + BRACKET WITH FAST WRENCH ADJUSTER (2020-24)

N° YC110-0135-02

€ 19



EMBOUIT PLASTIQUE DE GUIDON
BAR END CAPS

N° YC110-0153-01

€ 2



COCOTTE D'EMBRAYAGE
CLUTCH BRACKET

01 N° YC110-0134-04 (2020-24)
02 N° YC110-0126-01 (YCF 2005-17)

€ 15
€ 12

LEVIERS FREIN & EMBRAYAGE
BRAKE & CLUTCH LEVERS

04 N° YC110-0103-07 (EMBR./ CLUTCH) (PILOT/ SM/ FACTORY/ BIGY 2020-24) € 10
05 N° YC110-0501-014 (FREIN/ BRAKE) (2005-17) € 9
06 N° YC110-0103-03 (EMBR./ CLUTCH) (2005-17) € 9

CAOUTCHOUC DE LEVIER FREIN & EMBRAYAGE
RUBBER BRAKE & CLUTCH LEVERS

07 N° YC110-0502-01 (FREIN/ BRAKE)
08 N° YC110-0103-10 (EMBRAYAGE/ CLUTCH)

€ 3

LEVIER FREIN RÉGLABLE POUR KIT FREIN 4 PISTONS
ADJUSTABLE BRAKE LEVER FOR 4 PISTONS BRAKE KIT

03 N° YC110-0501-012

€ 9



SPECIAL PARTS
YCF RACING

POIGNÉES CAOUTCHOUC YCF (X2)
NOIRE/ BLEUE/ ROUGE/ VERTE/ JAUNE/ ORANGE/ ROSE/ BLANCHE/ GRISE

YCF RUBBER GRIPS (X2) BLACK/ BLUE/ RED/ GREEN/ YELLOW/ ORANGE/ PINK/ WHITE/ GREY

N° PPC011-COLOR

€ 12



DONUTS (X2) NOIR/ ROUGE/ VERT/ JAUNE/ ORANGE/ BLEU
GRIP DONUTS (X2) BLACK/ RED/ GREEN/ YELLOW/ ORANGE/ BLUE

N° DONUTZ-02-COLOR

€ 5



FOR 50 ONLY
LEVIER FREIN COMPLET AVEC COCOTTE POUR YCF 50
BRAKE LEVER COMPLETE WITH BRACKET FOR YCF 50

01 N° YC50-0501 (AVANT/ FRONT) (YCF 50 2012-19) € 10
02 N° YC50-01031 (ARRIÈRE/ REAR) (YCF 50 2012-19) € 10
03 N° YC50-0503-05 (FREIN AVANT/ FRONT BRAKE) (YCF 50 2020-24) € 8
04 N° YC50-0503-06 (FREIN ARRIÈRE/ REAR BRAKE) (YCF 50 2020-24) € 8



CÂBLE EMBRAYAGE
CLUTCH CABLE

01 N° YC110-0107 L=900mm A+B=93mm (SM125 2021-24/ SM190 2021) € 11
01 N° YC110-0108 L=900mm A+B=65mm (SP1/ SM150) € 11
01 N° YC110-0109-21 L=1000mm A+B=105mm (PILOT 150/ BIGY MX150)
01 N° YC110-0109-22 L=1000mm A+B=93mm (SP3 190/ BIGY 125MX 2022-24/ BIGY 190)
02 N° YC110-0109-11 L=950mm A+B=75mm (LITE 125/ START 125/ BIGY 125MX 2017-21)
02 N° YC110-0107-01 L=920mm A+B=75mm (SP2) € 12

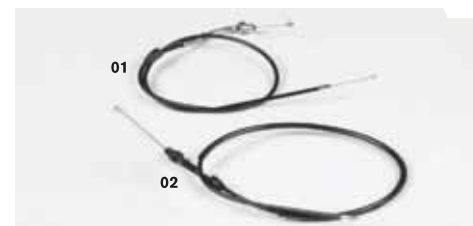

CÂBLE DE GAZ
THROTTLE CABLE

01 N° CGCOUDEE (CURVED OUTLET/ COUDÉ) € 12
02 N° YC110-0106 (ALL RANGE EXCEPT YCF50) € 12
02 N° YC50-0106-14 (FOR 50 ONLY) € 11
02 N° YC110-0106-12 (BIGY) € 13
02 N° YC110-0106-17 (LITE/START/PILOT/SM125/SP2 2021-24 NIBBI CARBURETOR)
02 N° YC110-0106-18 (BIGY 125/150 2021-24 NIBBI CARBURETOR) € 13

FOURCHES FORKS



KIT RÉFÉCTION FOURCHE TAILLE 33/46/11 : 1 JOINT SPY/ 1 CACHE POUSSIÈRE/ 1 BAGUE INF/ 1 BAGUE SUP

FORK REPAIR KIT SIZE 33/46/11 INCLUDING: 1 FORK OIL SEAL/ 1 DUST COVER/ 1 LOWER RING/ 1 UPPER RING

N° YC110-0470

€ 19

JOINT SPY FOURCHE

FORK OIL SEAL

01 N° YC50-0415 (POUR/ FOR 50 - 25X25X10)

€ 8

01 N° YC110-0440 (33*46*11) START/ PILOT/ FACTORY/ BIGY

€ 9



TÉ FOURCHE COMPLET 170MM SP3 48/48 (AVEC PONTETS GUIDON 28,6mm) (NOIR/ BLEU/ ROUGE/ VERT/ ORANGE)

TRIPLE CLAMP SET 48/48 170MM SP3
(WITH BAR MOUNTS 28,6mm)
(BLACK/ BLUE/ RED/ GREEN/ ORANGE)

01 N° YC110-0225-05-COLOR

€ 199



JEU TUBE FOURCHE UPSD RÉGLABLE

ADJUSTABLE FORK

N° YC110-0400-10 (735mm)

€ 349

N° YC110-0400-47 (775mm)

€ 399

N° YC110-0400-35 (800mm)

€ 359



JEU TUBE FOURCHE UPSD NON RÉGLABLE

UPSD FORK

N° YC110-0400-43 (600mm)

€ 209

N° YC110-0400-41 (660mm)

€ 209

N° YC110-0400-40 (735mm)

€ 209

N° YC110-0400-33 (785mm)

€ 239





TÉ FOURCHE COMPLET 160mm 45/48 OU 48/48 (NOIR/ BLEU/ ROUGE/ VERT/ ORANGE)
TRIPLE CLAMP SET 160mm 45/48 OR 48/48 (BLACK/ BLUE/ RED/ GREEN/ ORANGE)

N° YC110-02-053-COLOR (45/48)
N° YC110-02-049-COLOR (48/48)

€ 199
€ 199



JEU DE PONTETS GUIDON YCF 2012-2019
BAR MOUNTS FOR YCF 2012-2019

01 N° YC110-0203-05 (LITE/ START/ PILOT/ SM/ BIGY MX) Ø 22,2 € 39
02 N° YC110-0203-15 (SP3 2016-19/ BIGY 190 DAYTONA 2017-19) Ø 28,6 € 59
03 N° YC110-0222-01 CALE POUR PONTET GUIDON ÉPAISSEUR 20mm (VENDU PAR PAIRE) (NON RÉGLABLE/ NOT ADJUSTABLE) € 12
03 N° YC110-0222-02 CALE POUR PONTET GUIDON ÉPAISSEUR 20mm (VENDU PAR PAIRE) (RÉGLABLE/ ADJUSTABLE) € 20



JEU DE PONTETS GUIDON YCF 2020-24
BAR MOUNT FOR YCF 2020-24

04 N° YC110-0203-038 (FACTORY SP3/ BIGY 190 DAYTONA) Ø 28,6
05 N° YC110-0203-035 (50/ LITE/ START/ PILOT/ SP2/ BIGY MX) Ø 22,2
06 N° YC110-0222-03 CALE POUR PONTETS GUIDON (VENDU PAR PAIRE)

€ 69
€ 49
€ 12



ÉCROU POUR COLONNE DE DIRECTION
STREERING STEM NUT

01 N° YC110-02-09 (NOTCHED/ CRANTÉ)
02 N° YC110-02-11 (SUPÉRIEUR/ UPPER)

€ 6

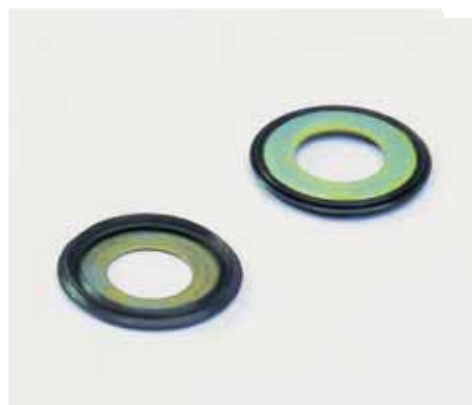

JOINT POUR COLONNE DE DIRECTION ADAPTABLE
SUR START/ PILOT/ FACTORY/ SM/ BIGY

SEAL FOR STEERING STEM ADAPTABLE ON START/ PILOT/
FACTORY/ SM/ BIGY

N° YC110-02-20

€ 6



JEU DE ROULEMENT COLONNE DIRECTION
TAPER ROLLER BEARING FOR STEERING STEM

N° KRDIRIRECTION41-2, YCF50 2012-19 – START 88 2008-19 – LITE88/125 2016-19
(INFÉRIEUR Ø EXT 41 - INT 24mm/ SUPÉRIEUR Ø EXT 41 - INT 22,5mm) € 29
N° KRDIRIRECTION46, ALL START 125 – PILOT – FACTORY – BIGY and 50A-E 2020-24 – START 88SE 2020-24
LITE 88-125 2020-24 (INFÉRIEUR Ø EXT 46 - INT 23,5mm/ SUPÉRIEUR Ø EXT 46 - INT 22mm) € 39



ÉCROU POUR COLONNE DE DIRECTION NOIR/ BLEU/ ROUGE/ VERT/ ORANGE
STREERING STEM NUT BLACK/ BLUE/ RED/ GREEN/ ORANGE

N° ECD-COLOR

€ 12



CADRES FRAMES



BÉQUILLE SIDE STAND

- 01 N° YC50-210-01 (50)
- 01 N° YC110-0904-01 (RÉGLABLE 250mm to 350mm)
- 01 N° YC110-0904-05 (BIGY) € 19

RESSORT DE BÉQUILLE SIDE STAND SPRING

- 02 N° YC110-19-01 € 3

VIS ET ÉCROU BÉQUILLE SIDE STAND SCREW & NUT

- 03 N° GB6170-M10-G (ÉCROU/ NUT)
- 04 N° FB02-M10x1,5x30I (VIS/ SCREW) € 2

KIT VIS RENFORCÉE POUR MOTEUR ENGINE REINFORCED SCREW SET

- 05 N° KITVIS8 (Ø 8)
- 05 N° KITVIS10 (Ø 10) € 9

PATTE DE CADRE FRAME STEEL PADS

- N° YC110-16-061BK (START F125) € 15
- N° YC110-16-067BK (PILOT 2013) € 25
- N° YC110-1622-02BK (PILOT 2014-2024) € 19
- N° YC110-1622-03 (BIGY) € 49



**CADRE RENFORCÉ 88 POUR BRAS MONO
(BOUCLE ARRIÈRE INCLUSE)**
88 REINFORCED FRAME FOR MONO SWING ARM
(REAR SUBFRAME INCLUDED)

N° YC88-161-0301-BK (START SE88) € 149



BOUCLE ARRIÈRE 88
88 REAR SUBFRAME

N° YC88-16-020 (START F88S)
N° YC88-16-022-BK (START F88SE) € 59



**CADRE RENFORCÉ LITE POUR BRAS CANTILEVER
(BOUCLE ARRIÈRE INCLUSE)**
LITE YCF REINFORCED FRAME FOR CANTILEVER SWING
ARM (REAR SUBFRAME INCLUDED)

N° YC110-161-0301-BK (LITE88) € 179
N° YC110-161-0401-BK (LITE 125/ 150) € 179



BOUCLE ARRIÈRE LITE
LITE REAR SUBFRAME

N° YC110-1614-23-BK (LITE F88) € 59
N° YC110-1614-24-BK (LITE F125/ F150) € 59



**CADRE START POUR BRAS MONO
ET AMORTISSEUR 270mm (BOUCLE AR. INCLUSE)**
START FRAME FOR MONO SWING ARM AND SHOCK
ABSORBER 270mm (REAR SUBFRAME INCL.)

N° YC110-166-0201-BK (START 125S) € 169



BOUCLE ARRIÈRE START 125
START 125 REAR SUBFRAME PART

N° YC110-16-070BK € 59
N° YC110-1614-28-BK (START 125SE) € 59



**CADRE COMPLET PILOT 125 & 150 2018-24
(AXE BRAS Ø 15) (BOUCLE ARRIÈRE INCLUSE)**
2018-24 PILOT 125 & 150 COMPLETE FRAME (ARM AXLE Ø 15)
(REAR SUBFRAME INCLUDED)

N° YC110-1621-0301-BK (NOIR/BLACK) (axle 15) € 299



BOUCLE ARRIÈRE PILOT
PILOT REAR SUBFRAME

N° YC110-1614-26-BK (2016-24) € 79



CADRE YCF 2019-2024 FACTORY (BOUCLE AR. INCLUSE)
2019-24 FACTORY YCF FRAME (REAR SUBFRAME INCL.)

N° YC110-1621-0801-BK (CADRE 22°) € 329



BOUCLE ARRIÈRE FACTORY
FACTORY REAR SUBFRAME

N° YC110-1614-15-BK (2016-24 ACIER/ STEEL) € 79
N° YC110-1614-18 (2016-24 ALUMINIUM) € 99



**CADRE YCF 2018-24 BIGY (AXE BRAS Ø 15) (BOUCLE
ARRIÈRE INCLUSE)**
2018-24 BIGY YCF FRAME (ARM AXLE Ø 15) (REAR SUBFRAME
INCLUDED)

N° YC110-1621-0201-BK (COMPLET) € 349

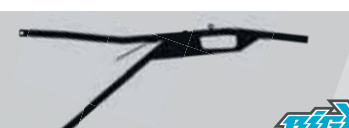

BOUCLE ARRIÈRE BIGY
BIGY REAR SUBFRAME

N° YC110-1614-08-BK (ACIER/ STEEL) € 99
N° YC110-1614-09-BK (190ZE/ F150E 2022-24) € 99

SELLES SEATS

FACTORY
SPECIAL PARTS
YCF RACING



SELLE COMPLÈTE ANTI DÉRAPANTE RENFORCÉE BLEUE/ ROUGE/ VERTE/ JAUNE/ ORANGE
COMPLETE NON-SLIP REINFORCED SEAT BLUE/ RED/ GREEN/ YELLOW/ ORANGE

N° YC110-1401-12-COLOR (BIGY)

€ 89

FACTORY
SPECIAL PARTS
YCF RACING



SELLE COMPLÈTE ANTI DÉRAPANTE RENFORCÉE BLEUE/ ROUGE/ VERTE/ JAUNE/ ORANGE
COMPLETE NON-SLIP REINFORCED SEAT BLUE/ RED/ GREEN/ YELLOW/ ORANGE

N° YC110-1401-08-COLOR (LITE 2016-24, START 2009-24, PILOT 125 2013-14)
N° YC110-1401-07-COLOR (PILOT 125 2015-24, PILOT 150, FACTORY, SM 150)

€ 65

€ 79



SELLE YCF POUR BIGY
YCF SEAT FOR BIGY

N° YC110-1401-11

€ 79

FACTORY
SPECIAL PARTS
YCF RACING



SELLE YCF LONGUE PILOT 125 2015-24/ PILOT 150 2013-24/ FACTORY 2012-24/ SM 150 2013-24/ SM 190 2023-2024
YCF LONG SEAT PILOT 125 2015-24/ PILOT 150 2013-24/
FACTORY 2012-24/ SM 150 2013-24/ SM 190 2023-2024

N° YC110-1401-17

€ 69

FOR 50 ONLY



01

02



SELLE YCF 50
YCF 50 SEAT

01 N° YC50-1401-05

€ 39

02 N° YC50-1401-03 (HAUTE/ HIGH + 4 cm)

€ 39



SELLE LITE 2016-24/ START 2009-24/ PILOT 125 2013-14
SEAT LITE 2016-24/ START 2009-24/ PILOT 125
2013-14

N° YC110-1401-10

€ 49



SELLE BASSE YCF POUR LITE 2016-24/ START 2009-24/ PILOT 125 2013-14
YCF LOW SEAT FOR LITE 2016-24/ START 2009-24/
PILOT 125 2013-14

N° YC110-140103

€ 49



FOR 50 ONLY



SELLE COMPLÈTE ANTI DÉRAPANTE RENFORCÉE BLEUE/ ROUGE/ VERTE/ JAUNE/ ORANGE
COMPLETE NON-SLIP REINFORCED SEAT
BLUE/ RED/ GREEN/ YELLOW/ ORANGE

N° YC50-1401-02-COLOR (50 SEULEMENT/ ONLY)

€ 59

RÉSERVOIRS FUEL TANKS



RÉSERVOIR ET COUVRE RÉSERVOIR YCF POUR BIGY
YCF FUEL TANK AND TANK COVER FOR BIGY

01 N° YC110-0701-04
02 N° YC110-0719-01

€ 59
€ 15



RÉSERVOIR YCF (ADAPTABLE SUR TOUTES LES ANCIENNES YCF ET SUR LES MINIS AVEC RÉSERVOIR TYPE CRF 50)
YCF FUEL TANK (CAN BE ADAPTED TO ALL PREVIOUS YCF AND TO MINI-BIKES WITH A TYPE CRF 50 FUEL TANK)

N° YC110-0701-01

€ 45



FOR 50 ONLY

RÉSERVOIR POUR YCF 50
FUEL TANK FOR YCF 50

N° YC50-07012

€ 39



BOUCHON RÉSERVOIR ALUMINIUM YCF NOIR/ BLEU ROUGE/ VERT/ ORANGE/
YCF ALUMINIUM GAS CAP BLACK/ BLUE / RED/ GREEN ORANGE

N° BOUCHONALU-COLOR

€ 35



VALVE PRISE AIR NOIRE/ BLEUE/ ROUGE/ VERTE/ ORANGE
FUEL VENT VALVE BLACK/ BLUE/ RED/ GREEN/ ORANGE

N° YC125-0704-COLOR

€ 9



DURITE ESSENCE BLEU/ ROUGE/ VERT/ JAUNE/ ORANGE/ ROSE
FUEL LINE BLUE/ RED/ GREEN/ YELLOW/ ORANGE/ PINK

N° DC-COLOR

€ 7



ROBINET ESSENCE
FUEL PETCOCK

01 N° 13020100 (2 EXITS/ 2 SORTIES)
02 N° YC110-0703 (1 EXIT FOR YCF/ 1 SORTIE POUR YCF)

€ 25



BOUCHON ET JOINT RÉSERVOIR PLASTIQUE
GAS CAP AND SEAL

01 N° YC110-0702-01 (YCF ORIGINAL DESIGN)
02 N° YC110-0720-02

€ 15
€ 3

FREINS BRAKES



PATTE DE FREIN CNC POUR ÉTRIER RADIAL
CNC ALUMINUM BRACKET FOR RADIAL BRAKE CALIPER

01 N° YC110-0510-06-SI (AV./FR. FOR DISK 220 MM)
01 N° YC110-0510-07-SI (AV./FR. FOR DISK 240 MM)
02 N° YC110-1210-06-SI (ARR./ REAR) € 39

**RESSORT ANTI VIBRATION
POUR ÉTRIER RADIAL ARRIÈRE**
REAR SPRING ANTI VIBRATION
FOR REAR CNC RADIAL BRAKE

03 N° YC110-1256-02 € 5

**RESSORT PLAQUETTE DE FREIN
POUR ÉTRIER RADIAL AVANT**
BRAKE PADS SPRING FOR FRONT CNC RADIAL BRAKE

04 N° YC110-0556-02 € 5

AXE DE PLAQUETTE DE FREIN POUR ÉTRIER RADIAL
BRAKE PADS AXLE FOR CNC RADIAL BRAKE

05 N° YC110-0555-02 (AVANT/ FRONT) € 4
06 N° YC110-1255-02 (ARRIÈRE/ REAR) € 4



KIT FREIN AVANT RADIAL
RADIAL FRONT BRAKE KIT

N° YC110-05012-09BK € 149



KIT FREIN ARRIÈRE RADIAL
RADIAL REAR BRAKE ASSEMBLY

N° YC110-12012-08BK € 149



MAÎTRE CYLINDRE FREIN AVANT SUPERMOTARD
SUPERMOTARD FRONT BRAKE MASTER CYLINDER

N° YC110-0507-01 € 99



LEVIER FREIN SEUL POUR MAÎTRE CYLINDRE FREIN AVANT SM
SM BRAKE LEVER FOR FRONT BRAKE MASTER CYLINDER

N° YC110-0503-02 € 39



ÉTRIER FREIN CNC RADIAL FACTORY
FACTORY BRAKE CALIPER RADIAL CNC

01 N° YC110-1201-06-BK (ARRIÈRE/ REAR)
02 N° YC110-0502-06-BK (AVANT/ FRONT) € 115



KIT FREIN AVANT FACTORY (LEVIER RÉGLABLE) 2016-24
 FACTORY FRONT BRAKE KIT (ADJUSTABLE LEVER) 2016-24

N° YC110-0501-3101 (SP2/ SP3/ BIGY) € 89



KIT FREIN ARRIÈRE FACTORY 2016-2024
 FACTORY REAR BRAKE ASSEMBLY 2016-2024

N° YC110-12012-2601 (SP2/ SP3)
 N° YC110-12012-2801 (BIGY FACTORY) € 90



KIT FREIN ARRIÈRE HYDRAULIQUE YCF 50 2020-24 (ADAPTABLE SUR LES YCF 50 2012-2019)
 HYDRAULIC REAR BRAKE KIT YCF 50 2020-24 (CAN FIT ON YCF 50 2012-2019)

N° YC50-1214-03 € 79



KIT FREIN AVANT HYDRAULIQUE YCF 50 2020-24 (ADAPTABLE SUR LES YCF 50 2012-2019)
 HYDRAULIC FRONT BRAKE KIT YCF 50 2020-24 (can fit on YCF 50 2012-2019)

N° YC50-0511-03 € 79





ÉTRIER FREIN AVANT
FRONT BRAKE CALIPER

- 01 N° YC110-0501-0205 (DOUBLE PISTON) (START 125-BIGY 125-150 MX) € 59
- 02 N° YC110-0501-0203 (4 PISTONS) € 59
- 03 N° YC50-0502 (YCF 50) € 39
- 08 N° YC110-0501-0207 (SP3 2016-24 - BIGY FACTORY 150-190) € 69

MAITRE CYLINDRE AVANT
FRONT BRAKE MASTER CYLINDER

- 04 N° YC110-0501-0103 (FREINAGE À GAUCHE) € 49
- 04 N° YC110-0501-0104-02 (DOUBLE PISTON) (LITE/ START) € 49
- 05 N° YC110-0501-0101 (4 PISTONS) € 49
- 07 N° YC110-0501-0104-03 (PILOT/ FACTORY/ BIGY 2016-24) € 59

DURITE FREIN AVANT
FRONT BRAKE HOSE

- 06 N° YC110-0501-0325 (FILETAGE AU MAÎTRE CYLINDRE) (LITE/START) € 29
- 06 N° YC110-0501-0327 (BANJO AU MAÎTRE CYLINDRE) (SP2/ SP3/ BIGY)



KIT FREIN COMPLET AVANT AVEC ÉTRIER DOUBLE PISTON
COMPLETE FRONT BRAKE KIT WITH DOUBLE PISTON CALIPER

- N° YC110-0501-1801 (LITE/ START 125)
- N° YC110-0501-3301 (BIGY/ PILOT/ SM F150)

€ 75



KIT FREIN AVANT COMPLET START F88
COMPLETE FRONT BRAKE KIT START F88

- N° YC110-0501-2001 (START 88 2020-24)
- N° YC110-0501-20 (START 88 2010/2019)

€ 75
€ 75





ÉTRIER FREIN ARRIÈRE
REAR BRAKE CALIPER

- 01 N° YC110-1201-0401 (1 PISTON) (LITE/ START/ PILOT/ BIGY 125-150 MX) € 59
- 02 N° YC110-0501-0203 (4 PISTONS) € 39
- 03 N° YC50-1201 (YCF 50) € 39
- 08 N° YC110-1201-07 (SP3 2016-24/ BIGY FACTORY 150-190) € 69

MAÎTRE CYLINDRE FREIN ARRIÈRE
REAR BRAKE MASTER CYLINDER

- 04 N° YC110-1201021 (Ø 8/ DIST. 40mm) (START) € 30
- N° YC110-1201023 (Ø 10/ DIST. 40mm) (SM 190) € 30
- 07 N° YC110-1201024 (PILOT/ FACTORY / BIGY) € 39
- N° YC110-1201026 (Ø 10/ LITE) € 39

JEU DE CAOUTCHOUCS ÉTRIER FREIN ARRIÈRE
SET OF REAR BRAKE CALIPER RUBBER

- 05 N° YC110-120110 € 5

DURITE FREIN ARRIÈRE Ø 10 ÉTRIER
REAR BRAKE HOSE CONNECTION Ø 10 CALIPER

- 06 N° YC110-1201061 (Ø 8 MASTER CYLINDER) 370mm (START)
- 06 N° YC110-1201062 (Ø 8 MASTER CYLINDER) 465mm (PILOT)
- 06 N° YC110-1203-04 (Ø 10/ MASTER CYLINDER) 425 (LITE)
- 06 N° YC110-1201052 (Ø 10/ MASTER CYLINDER) 465mm (SP2)
- 06 N° YC110-1201063 (Ø 10/ MASTER CYLINDER) 515mm (SP3/ BIGY) € 19



KIT FREIN COMPLET ARRIÈRE 1 PISTON
COMPLETE REAR BRAKE ASSEMBLY

- N° YC110-12012-0601 (START) € 79
- N° YC110-12012-3101 (LITE) € 79
- N° YC110-12012-2701 (BIGY) € 79
- N° YC110-12013-0301 (360 mm START 88SE 2020-24) € 79
- N° YC110-12012-2401 (PILOT/ SM F150) € 79



MAÎTRE CYLINDRE AVEC BOCAL
MASTER CYLINDER WITH RESERVOIR

- N° YC110-120102 € 35





FACTORY

**PÉDALE DE FREIN PILOT/FACTORY/BIGY
AVEC ROULEMENT**

PILOT/FACTORY/BIGY BRAKE PEDAL WITH BEARING

N° YC110-219-03

€ 49



FACTORY

PÉDALE DE FREIN PILOT/FACTORY/BIGY AVEC ROULEMENT

PILOT/FACTORY/BIGY BRAKE PEDAL WITH BEARING

N° YC110-219-03-BK

€ 49



START

PÉDALE FREIN ALUMINIUM POUR 88/125 START

ALUMINIUM BRAKE PEDAL FOR 88/125 START

N° YC110-218

€ 49



FOR 50 ONLY



KIT PÉDALE FREIN AU PIED POUR YCF 50 2012-24

BRAKE PEDAL KIT FOR YCF 50 2012-24

N° YC50-1219

€ 49



START

PÉDALE FREIN ACIER POUR START 88/125

STEEL BRAKE PEDAL FOR 88/125 START

N° YC110-211

€ 25



**PÉDALE DE FREIN ALUMINIUM HAUT DE GAMME
2010-2011-CLASSIC 2012**

ALUMINIUM BRAKE PEDAL HIGH-RANGE 2010-2011-
CLASSIC 2012

N° YC110-215

€ 49



**EMBOU PÉDALE FREIN ALUMINIUM NOIR/ BLEU/
ROUGE/ VERT/ ORANGE**

COLOR REAR BRAKE LEVER TIPS BLACK/ BLUE/ RED/
GREEN/ ORANGE

N° YC110-1223-02-COLOR

€ 15



PÉDALE DE FREIN ACIER

STEEL BRAKE PEDAL

N° YC110-217-02 (PILOT/ SM150 2013-24)

€ 25



**CHAPE MAÎTRE CYLINDRE FREIN ARRIÈRE CNC
NOIR/ BLEU/ ROUGE/ VERT/ ORANGE**

CNC REAR BRAKE CLEVIS BLACK/ BLUE/ RED/ GREEN/
ORANGE

N° EMC-COLOR

N° EMC01-COLOR (PILOT/ FACTORY/ BIGY 2016-24)

€ 15



**PROTECTION MAÎTRE CYLINDRE FREIN ARRIÈRE
POUR LITE/ START 2007-24/ PILOT/ FACTORY 2007-15**

REAR BRAKE MASTER CYLINDER GUARD
FOR LITE/ START 2007-24/ PILOT/ FACTORY 2007-15

N° YC110-1224

€ 15



EMBOU PÉDALE FREIN

REAR BRAKE LEVER TIPS

01 N° YC110-1223-01 (ACIER/ STEEL)

€ 6

02 N° YC110-1223-02 (ALUMINIUM)

€ 15

**CÂBLE DE PÉDALE DE FREIN ARRIÈRE AVEC GAINÉ
(POUR ÉVITER DE TORDRE LA PÉDALE DE FREIN)**

REAR BRAKE PEDAL CABLE WITH SHEATH
(TO AVOID BRAKE PEDAL TWISTING)

03 N° YC110-1260-01

€ 8

RESSORT PÉDALE FREIN

BRAKE PEDAL SPRING

04 N° YC110-21-01 (ACIER/ STEEL)

04 N° YC110-21-05 (ALUMINIUM)

04 N° YC110-21-06 (ALUMINIUM FACTORY)

€ 5

FACTORY 190 SP3

YCF FACTORY DAYTONA 190 ANIMA
RIDER : JORDI TIXIER
TEAM : YCF FRANCE





DISQUE DE FREIN ENTRAXE 102,5mm Ø INT. 76mm
BRAKE DISC CENTER TO CENTER DISTANCE 102,5mm
INNER Ø 76mm

- Nº YC110-0513-02 (AVANT/ FRONT 220mm) € 39
- Nº YC110-1115-01 (ARRIÈRE/ REAR 200mm) € 39
- Nº YC110-1115-06 (200mm PERCÉ EN 10mm) € 39
- Nº YC110-1115-07 (220mm PERCÉ EN 10mm) € 39



KIT VIS INOX POUR DISQUE DE FREIN
INOX BOLT KIT FOR BRAKE DISC

- Nº KVD (DIAM 8) € 5
- Nº KVD-01 (DIAM 10) € 5



DISQUE FREIN AVANT FLOTTANT 220mm
SEMI FLOATING BRAKE ROTOR

- Nº YC110-0613-01-BK € 99



DISQUE DE FREIN AVANT 240mm AVEC PATTE DE DÉPORT
240mm FRONT BRAKE DISC WITH LEG OFFSET

- Nº KS2 € 69



DISQUE DE FREIN AVANT FLOTTANT 240mm AVEC PATTES DE DÉPORT
240mm SEMI FLOATING BRAKE ROTOR WITH CALIPER MOUNTING BRACKETS KIT

- Nº KS2-1 € 129



JEU DE PLAQUETTES FREIN AV. & AR. POUR YCF 50
SET OF BRAKE PADS FRONT & REAR FOR YCF 50

- 01 Nº YC50-0506 (2012-2019) € 15
- 19 Nº YC50-0506-02 (YCF 50 2020-24 HYDRAULIQUE) € 16

JEU DE PLAQUETTES FREIN ARRIÈRE
REAR BRAKE PADS

- 02 Nº YC110-120107
- 03 Nº YC110-120108
- 04 Nº 14030213/4N (YCF 2005)
- 17 Nº YC110-1204-02 (SP 2016-24/ BIGY/ FACTORY 2017-24) € 17

JEU DE PLAQUETTES FREIN AR. 1 PISTON YCF
REAR BRAKE PADS SINGLE 1 PISTON YCF

- 05 Nº YC110-120104 (START 2012-24/ LITE 2016-24) € 17

JEU DE PLAQUETTES FREIN AVANT YCF 2005
FRONT BRAKE PADS YCF 2005

- 06 Nº 14010114/5 € 15

JEU DE PLAQUETTES FREIN AVANT/ARRIÈRE POUR ÉTRIER 4 PISTONS POUR YCF 2007 ET 88 2009-11
BRAKE PADS FRONT/REAR FOR 4 PISTONS CALIPER FOR YCF 2007 AND 88 2009-11

- 08 Nº YC110-0501-0401 € 15

JEU DE PLAQUETTES FREIN AVANT
FRONT BRAKE PADS

- 07 Nº YC110-0501-0405
- 09 Nº YC110-0501-0404
- 10 Nº YC110-0501-0406
- 18 Nº YC110-0501-0416 (SP 2016-24/ BIGY/ FACTORY 2017-24) € 17

JEU DE PLAQUETTES SIMPLE PISTON POUR YCF 2006
BRAKE PADS SINGLE PISTON FOR YCF 2006

- 11 Nº YC110-0501-0402 € 15

JEU DE PLAQUETTES FREIN AVANT YCF 2008-13
FRONT BRAKE PADS YCF 2008-13

- 12 Nº YC110-0501-0403 € 17

VIS PLAQUETTE FREIN AVANT OU ARRIÈRE
FRONT OR REAR BRAKE PADS SCREW

- 13 Nº YC110-1255 (ARRIÈRE/ REAR)
- 14 Nº YC110-0555 (AVANT/ FRONT) € 2

JEU DE PLAQUETTES FREIN RADIAL AV. & AR.
SET OF RADIAL BRAKE PADS FRONT & REAR

- 15 Nº YC110-0506-01 (AVANT/ FRONT)
- 16 Nº YC110-1204-01 (ARRIÈRE/ REAR) € 17



MC Photo



FACTORY
SPECIAL PARTS
YCF RACING

CAPOT MAÎTRE CYLINDRE FREIN AVANT CNC
NOIR/ BLEU/ ROUGE/ VERT/ ORANGE
FRONT BRAKE RESERVOIR COVER BLACK/ BLUE/ RED/ GREEN/ ORANGE

N° FBRC-COLOR (ALL YCF MODELS EXCEPT PILOT/ FACTORY 2016-2024)
N° FBRC01-COLOR (PILOT/ FACTORY/ BIGY 2016-24)

€ 15



FACTORY
SPECIAL PARTS
YCF RACING

CAPOT MAÎTRE CYLINDRE FREIN ARRIÈRE CNC
NOIR/ BLEU/ ROUGE/ VERT/ ORANGE
REAR BRAKE RESERVOIR COVER BLACK/ BLUE/ RED/ GREEN/ ORANGE

N° RBRC-COLOR (ALL YCF MODELS EXCEPT PILOT/ FACTORY 2016-2024)
N° RBRC01-COLOR (PILOT/ FACTORY/ BIGY 2016-24)

€ 15

BRAS OSCILLANTS SWING ARMS



DIABOLO CNC NOIR/ BLEU/ ROUGE / VERT/ ORANGE
CNC REAR SPOOL BLACK/ BLUE/ RED/ GREEN/ ORANGE

N° KRS-COLOR

€ 17



FACTORY
SPECIAL PARTS
YCF RACING

BRAS OSCILLANT MONO ALU RENFORCÉ
ALUMINUM REINFORCED MONO SWING ARM

- N° YC110-10015-0101 (420mm POUR/ FOR SP2 2014-2024/ SP3 2014-18) € 249
- N° YC110-1001-2102 (460mm POUR/ FOR SP3 2019-24) € 249
- N° YC110-1001-10 (460mm, AXE 12 POUR/ FOR BIGY 2017) € 249
- N° YC110-1001-1603 (460mm, AXE 15 POUR/ FOR BIGY 2018-24) € 249
- N° YC110-1001-23 (490mm, AXE 15 POUR/ FOR BIGY SM 17/17 ou BIGY MX 16/19) € 259



BRAS OSCILLANT MONO CHROMOLY START
START MONO CHROMOLY SWING ARM

- N° YC110-1001-0701 (350mm) (START 88)
- N° YC110-10014-01 (390mm) (START 125)

€ 119



BRAS OSCILLANT MONO CHROMOLY
CHROMOLY MONO SWING ARM

- N° YC110-1001-05 (420mm, AXE 12 POUR/ FOR PILOT 2015-17)
- N° YC110-1001-1701 (420mm, AXE 15 POUR/ FOR PILOT 2018-24)
- N° YC110-1001-1501 (460mm, AXE 15 POUR/ FOR BIGY 2018-24)

€ 149

€ 179



BRAS OSCILLANT CANTILEVER LITE
LITE CANTILEVER SWING ARM

N° YC110-1001-1201

€ 89



PROTÈGE DISQUE ARRIÈRE RENFORCÉ NYLON
REINFORCED NYLON REAR DISC GUARD

N° YC110-1024-04

€ 29



PROTÈGE DISQUE ARRIÈRE
REAR DISC GUARD

N° YC110-1010

€ 15



VIS ET ÉCROU TENDEUR DE CHAÎNE
BOLT AND NUT FOR BLOCK AXLE

01 N° GB5783-M8X40-W (VIS/ SCREW)
02 N° FB6170-M8-W (ÉCROU/ NUT)

€ 3
€ 2



AXE BRAS OSCILLANT
AXLE SWING ARM

01 N° YC110-10-03 (Ø 10/ L: 185mm)
02 N° YC110-10-034 (Ø 12/ L: 192mm)
02 N° YC110-10-033 (Ø 12/ L: 236mm: FACTORY 2012-24)
02 N° YC110-10-035 (Ø 12/ L: 240mm: PILOT)
03 N° YC110-1009-01 (Ø 15: PILOT/ BIGY 2018-24)

€ 6



ROULEMENT BRAS OSCILLANT
SWING ARM BEARING

04 N° 6200/30-10 (Ø EXT, 30/ Ø INT, 10)
04 N° 6001/28-10 (Ø EXT, 28/ Ø INT, 10)
04 N° 6001/28-12-08 (Ø EXT, 28/ Ø INT, 12)
04 N° 6001/28-15-08 (Ø EXT, 28/ Ø INT, 15) (PILOT/ BIGY 2018-24)

€ 6



ROULETTE CHAÎNE
CHAIN TENSIONER

01 N° YC110-2201-02
01 N° YC50-2201-02 (50E-W88)
01 N° YC110-2201-03 (SP3)

€ 12
€ 12
€ 15



GUIDE CHAÎNE ARRIÈRE
REAR CHAIN GUIDE

02 N° YC110-1004 (PILOT - BIGY)
03 N° YC110-1005 (START - LITE)

€ 39



GUIDE CHAÎNE RENFORCÉ FACTORY 2019-24 ADAPTABLE SUR TOUTES LES PILOT/ FACTORY/ BIGY

2019-24 FACTORY REINFORCED CHAIN GUIDE SUITABLE FOR ALL PILOT/ FACTORY/ BIGY

N° YC110-1018-04

€ 45



PATIN CHAÎNE R START 2011-2024
CHAIN SLIDER FOR R START 2011-2024

01 N° YC110-10-023

€ 15

PATIN BRAS OSCILLANT POUR BRAS ALU 420mm OU 460mm 2011-2024
SWING ARM SLIDER FOR 420mm OR 460mm ALUMINIUM ARM 2011-2024

02 N° YC110-10-025

€ 15

PATIN BRAS OSCILLANT CANTILEVER LITE
LITE CANTILEVER SWING ARM SLIDER

03 N° YC110-1005-02

€ 15

PATIN CHAÎNE COURT POUR BRAS CANTILEVER
SHORT CHAIN SLIDER ADAPTABLE FOR CANTILEVER ARM

04 N° YC110-10-021

€ 10

AMORTISSEURS SHOCK ABSORBERS

FACTORY
SPECIAL PARTS
YCF RACING



AMORTISSEUR SHOCK ABSORBER

01 N° YC50-0404-03 (200mm YCF 50)	€ 89
02 N° YC110-0404-82 (270mm CANTILVER - LITE 88 - 125)	€ 129
03 N° YC110-0404-15 (265mm MONO ARM/ BRAS - START F88)	€ 129
03 N° YC110-0404-14 (270mm MONO ARM/ BRAS - START F125)	€ 129
03 N° YC110-0404-17 (310mm MONO ARM/ BRAS - PILOT 125/150 2013-20 & SM150 2013-24)	€ 139
03 N° YC110-0404-81 (330mm MONO ARM/BRAS PILOT 125/150 2020-24)	€ 139
03 N° YC110-0404-67 (355mm MONO ARM/ BRAS - BIGY)	€ 139
04 N° YC110-0404-07 (280mm RÉGLABLE/ ADJUSTABLE)	€ 199
04 N° YC110-0404-16 (330mm RÉGLABLE/ ADJUSTABLE - SP2)	€ 199
04 N° YC110-0404-68 (355mm RÉGLABLE/ ADJUSTABLE - BIGY)	€ 199

ENTRETOISE D'AMORTISSEUR Ø 12 SHOCK ABSORBER SPACERS Ø 12

05 N° YC110-0419 (START/ PILOT 2010-2024)	€ 4
06 N° YC110-04192 (RSP, CLASSIC, FACTORY 2010-2024)	€ 6



AMORTISSEUR DNM DNM SHOCK ABSORBER

N° YC110-0404-83 270mm ressort/spring 800lbs	€ 319
N° YC110-0404-84 270mm ressort/spring 1000lbs	€ 339
N° YC110-0404-35 310mm ressort/spring 1000lbs	€ 339
N° YC110-0404-59 330mm ressort/spring 1000lbs	€ 339
N° YC110-0404-86 345mm ressort/spring 1200lbs (BIGY SM 190)	€ 339
N° YC110-0404-99 355mm ressort/spring 800 lbs (BIGY)	€ 339



KIT RABASSE AMORTISSEUR HEIGHT ADJUSTMENT KIT

01 N° YC110-1033-01 (START 88S-125-125S)	€ 59
02 N° YC110-1030-02 (LITE)	€ 59



RESSORT PLUS SOUPLE ET PLUS DUR SOFTER AND HARDER SPRING

01 N° YC110-0417-22-WH (START/ SM 88-125)	€ 39
N° YC110-0417-23-WH (PILOT 125-150/ SM 150) (SOUPLE 600 lbs)	€ 39
02 N° YC110-0417-27-BK (START/ SM 88-125)	€ 39
N° YC110-0417-28-BK (PILOT 125-150/ SM 150) (DUR 800 lbs)	€ 39
03 N° YC110-0417-46-BK 355mm 1000 LBS (BIGY)	€ 39



BAVETTE D'AMORTISSEUR YCF YCF MUD FLAP

N° YC110-0460-01 (POUR/FOR PILOT/ FACTORY/ BIGY)	€ 15
--	------

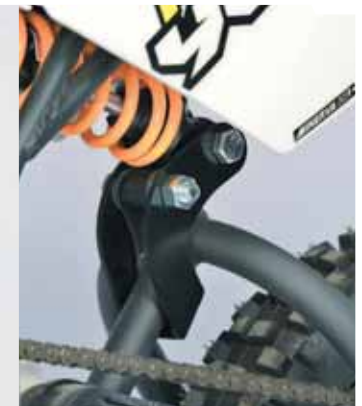

ROUES, JANTES & MOYEUX WHEELS, RIMS & HUBS



KIT ROUE SUPERMOTO YCF 10"
(2.15 X 10" AVANT/ 2.50 X 10" ARRIÈRE)
YCF SUPERMOTO WHEEL SET 10"
(2.15 X 10" FRONT/ 2.50 X 10" REAR)

N° YC110-0625-01-BK

€ 219



KIT ROUE YCF 12"
(2.15 X 12" AVANT/ 2.75 X 12" ARRIÈRE)
YCF WHEEL SET 12"
(2.15 X 12" FRONT/ 2.75 X 12" REAR)

N° YC110-0626-01-BK

€ 249



ROUE SUPERMOTO ALU 17-17
(VENDUE AVEC DISQUE DE FREIN & COURONNE)
SUPERMOTO WHEEL ALU
(SOLD WITH BRAKE DISC & SPROCKET)

N° YC110-0601-32-BK (2.50x17 AVANT/ FRONT) € 299
N° YC110-1101-70-BK (3.50x17 ARRIÈRE/ REAR) € 299



ROUE SUPERMOTO ALU
(VENDUE AVEC DISQUE DE FREIN & COURONNE)
SUPERMOTO WHEEL ALU
(SOLD WITH BRAKE DISC & SPROCKET)

N° YC110-0601-93 (2.50x14" AVANT/ FRONT) € 159
N° YC110-1101-73 (3.00x14" ARRIÈRE/ REAR) € 199



ROUE SUPERMOTO (ACIER)
(VENDUE AVEC DISQUE DE FREIN & COURONNE)
SUPERMOTO STEEL WHEEL
(SOLD WITH BRAKE DISC)

N° YC110-06017 (1,85x12" AVANT/ FRONT) € 119
N° YC110-11014 (2,15x12" ARRIÈRE/ REAR) € 129



VALVE COUDE 90° NOIR/ BLEU/ ROUGE/ VERT/ ORANGE
YCF 90° INNER TIRE VALVES BLACK/ BLUE/ RED/ GREEN/ ORANGE

N° ITV02-COLOR

€ 10



10 12 14

ROUE ACIER POUR AXE DE ROUE DE 15" AVEC RAYONS RENFORCÉS 4mm

STEEL WHEEL FOR 15" WHEEL AXLE WITH 4mm REINFORCED SPOKES

- N° YC110-0601-2901 (AVANT/ FRONT 12") € 119
- N° YC110-0601-3001-BK (AVANT/ FRONT 14") € 119
- N° YC110-0601-0801 (88CC : AVANT/ FRONT 10") € 119
- N° YC110-1101-3401-BK (ARRIÈRE/ REAR 12") € 149
- N° YC110-1101-01A (ARRIÈRE/ REAR 10") € 149



FOR 50 ONLY

10

ROUE AVANT OU ARRIÈRE COMPLÈTE YCF 50

COMPLETE FRONT OR REAR WHEEL FOR YCF 50

- N° YC50-0601-0401 (AVANT/ FRONT) € 99
- N° YC50-1101-0401 (ARRIÈRE/ REAR) € 139



12 14

ROUE COMPLÈTE ACIER RENFORCÉE POUR AXE DE ROUE DE 15", MOYEURS ARRIÈRE AVEC 5 VIS DE FIXATION POUR COURONNE

COMPLETE REINFORCED STEEL WHEEL AXLE 15", REAR HUB WITH 5 SCREWS FIXATION FOR SPROCKET

- N° YC110-0601-5B (AVANT/ FRONT 14") € 129
- N° YC110-1101-2D (ARRIÈRE/ REAR 12") € 159



FOR 50 ONLY

10

ROUE COMPLÈTE AVEC MOYEURS CNC NOIRE/ BLEUE/ ROUGE/ VERTE/ ORANGE

COMPLETE WHEEL WITH CNC HUB BLACK/ BLUE/ RED/ GREEN/ ORANGE

- N° YC50-0611-01-COLOR (AVANT/ FRONT) € 129
- N° YC50-1101-COLOR (ARRIÈRE/ REAR) € 149



14 17

ROUE COMPLÈTE ACIER RENFORCÉE POUR AXE DE ROUE DE 15", MOYEURS ARRIÈRE AVEC 5 VIS DE FIXATION POUR COURONNE

COMPLETE REINFORCED STEEL WHEEL AXLE 15", REAR HUB WITH 5 SCREWS FIXATION FOR SPROCKET

- N° YC110-0601-39-BK (AVANT/ FRONT 17") € 139
- N° YC110-1101-29-BK (ARRIÈRE/ REAR 14") € 149



16 19

ROUE AVANT OU ARRIÈRE COMPLÈTE 16"/19" CERCEAU ALUMINIUM

COMPLETE FRONT OR REAR WHEEL 16"/19" ALUMINIUM RIM

- N° YC110-0601-34-BK (1,60x19" AVANT/ FRONT) € 199
- N° YC110-1101-72-BK (1,85 x16" ARRIÈRE/ REAR) € 299

ROUE COMPLÈTE RENFORCÉE, MOYEUX CNC,
CERCEAU ALU, 7116, VENDUE AVEC DISQUE & COURONNE
NOIRE/ BLEUE/ ROUGE/ VERTE/ ORANGE

COMPLETE REINFORCED WHEEL, CNC HUB, ALU,
7116 RIM (SOLD WITH BRAKE DISC & SPROCKET)
BLACK/ BLUE/ RED/ GREEN/ ORANGE

N° YC110-0601-40-COLOR (AVANT/ FRONT 17") € 179
N° YC110-1101-32-COLOR (ARRIÈRE/ REAR 14") € 229

14 17

FACTORY
SPECIAL PARTS
YCF RACING



AI 7116

YCF



AL 7116



CERCEAU DE ROUE ALU. 7116

ALUMINUM 7116 M SHAPE RIM

ROUE COMPLÈTE RENFORCÉE, MOYEURS CNC, CERCEAU ALU, 7116, VENDUE AVEC DISQUE & COURONNE NOIRE/ BLEUE/ ROUGE/ VERTE/ ORANGE

COMPLETE REINFORCED WHEEL, CNC HUB, ALU, 7116 RIM (SOLD WITH BRAKE DISC & SPROCKET) BLACK/ BLUE/ RED/ GREEN/ ORANGE

N° YC110-06012-COLOR (AVANT/ FRONT 12")
N° YC110-0601-37 (AVANT/ FRONT 14")
N° YC110-1101-25 (ARRIÈRE/ REAR 12")

€ 149
€ 169
€ 219

N° YC110-1107-BK (1,85x12" AV./ FRONT - AR./ REAR)
N° YC110-1107-16-SI (1,85x12" AV./ FRONT) € 59
N° YC110-0617-24-BK (2,50x14" AV./ FRONT) € 79
N° YC110-0617-24-SI (1,40x14" AV./ FRONT) € 79
N° YC110-0617-40-BK (1,60x17" AV./ FRONT) € 59
N° YC110-1107-32-BK (1,85x14" AR./ REAR) € 59
N° YC110-0617-41-BK (2,50x17") € 139
N° YC110-1107-54-BK (3,50x17") € 149
N° YC110-1107-55-BK (2,15x16") € 99
N° YC110-0617-42-BK (1,60X19") € 99



CERCEAU DE ROUE ACIER POUR RAYON 4mm
STEEL RIM WITH 4mm SPOKES

- N° YC110-1107-34-BK (1,85X12 AV/ FRONT - AR/ REAR) € 30
- N° YC110-1101-014 (2,15X12 AV/ FRONT - AR/ REAR) € 30
- N° YC110-0617-19-BK (1,40x12 AV/ FRONT) € 30
- N° YC110-0617-30-BK (1,40x14 AV/ FRONT) € 30
- N° YC110-0617-39-BK (1,60x17 AV/ FRONT) € 30
- N° YC110-1107-29-BK (1,85x14 AR/ REAR) € 30



ROULEMENT DE ROUE AVANT OU ARRIÈRE
FRONT OR REAR WHEEL BEARING

- 01 N° 96140-6202-2Z € 6

JOINT SPY DE ROUE
WHEEL OIL SEAL

- 02 N° YC50-0610 (Ø22X31.5X5) (POUR/ FOR YCF 50)
- 02 N° YC110-0610 (Ø25X35X6.5)
(POUR MOYEUX CNC 2012/ FOR CNC HUB)
- 02 N° YC110-0611 (Ø23X35X5) (POUR MOYEUX
INJECTÉ-CNC/ FOR MOLDED-CNC HUB) € 6

GRIPSTER ARRIÈRE OU AVANT
REAR OR FRONT RIM LOCK

- 03 N° GRIPSTERAR-R (ARRIÈRE/ REAR)
- 03 N° GRIPSTERA-V-R (AVANT/ FRONT) € 15



JEU DE RAYONS AVANT OU ARRIÈRE 4mm
FRONT OR REAR SET OF SPOKES 4mm

AVANT/ FRONT:

- N° JR10-10.6 (50A/ 50E)
- N° JR12-12.1-8K (88E/ START 88SE)
- N° JR12-12.5 (SM)
- N° JR10-10.1-8K (LITE 88)
- N° JR14-14.8-8K (LITE 125/ START 125S/ START 125SE
/ PILOT 125/ PILOT 150)
- N° JR14-15.0-8K (SP2/ SP3)
- N° JR17-18.4-8K (BIGY 125/ 150)
- N° JR17-18.5-8K (BIGY F150/ 190D/ 190ZE)
- N° JR17-18.6-8K (BIGY SM 17')
- N° JR19-21.3-8K (BIGY 19") € 25

ARRIÈRE/ REAR:

- N° JR10-10.5 (50A/ 50E)
- N° JR10-10.4-8K (88E/ LITE 88/ START 88SE)
- N° JR12-12.8-8K (LITE 125/ START 125S/ START 125SE
/ PILOT 125/ PILOT 150)
- N° JR12-13.5-8K (SP2/ SP3)
- N° JR12-12.6-10K (SM)
- N° JR14-15-8K (BIGY 125/ 150)
- N° JR14-15.1-8K (BIGY F150/ 190D/ 190ZE)
- N° JR16-17.5-8K (BIGY 16')
- N° JR17-18.4-8K (BIGY SM 17') € 25



AXE DE ROUE AVANT OU ARRIÈRE
FRONT OR REAR WHEEL AXLE

- 01 N° YC110-11-075 (FACTORY 2011-2024)
- 02 N° YC110-11-07 (ARRIÈRE/ REAR)
- 03 N° YC110-06-06 (AVANT/ FRONT)
- 04 N° YC110-06-061 (TYPE MARZOCCHI®) € 7



COUVRE RAYON (KIT DE 38 PCS AVANT 215 MM/ 38 PCS ARRIÈRE 190mm)
BLEU/ ROUGE/ VERT/ JAUNE/ ORANGE/ ROSE

SPOKE SKIN SET (INCLUDES 38 FRONT PCS-215mm & 38 REAR PCS-190mm)
BLUE/ RED/ GREEN/ YELLOW/ ORANGE/ PINK

N° SPKAS01-COLOR

€ 19



MOYEU ROUE AVANT OU ARRIÈRE CNC NOIR/ BLEU/ ROUGE/ VERT/ ORANGE

WHEEL HUB CNC FRONT OR REAR BLACK/ BLUE/ RED/ GREEN/ ORANGE

- 01 N° YC110-0622-22-COLOR (AVANT/ FRONT) € 99
 02 N° YC110-1122-16-COLOR (ARRIÈRE/ REAR) € 119

JEU ENTRETOISES DE ROUE CNC POUR MOYEU INJECTÉE LITE/ START/ PILOT/ BIGY MX125/150 NOIRES/BLEUES/ ROUGES/ VERTES/ ORANGES

SET OF CNC WHEEL SPACERS FOR CASTING HUB LITE/ START/ PILOT/ BIGY MX125/150 BLACK/ BLUE/ RED/ GREEN/ ORANGE

- 03 N° ERC1AV-COLOR (AVANT/ FRONT 15x22x33 & 15x22x23) € 15
 03 N° ERC1AR-COLOR (ARRIÈRE/ REAR 15x22x38 & 15x22x29)

ENTRETOISE DE ROUE

WHEEL SPACER

- 04 N° YC110-06-052 (AVANT GAUCHE/ FRONT LEFT) Ø 15X22X33 LITE/ START/ PILOT/ BIGY MX125-150
 04 N° YC110-06-047 (AVANT DROITE/ FRONT RIGHT) Ø 15X22X23 LITE/ START/ PILOT/ BIGY MX125-150
 04 N° YC110-11-052 (ARRIÈRE GAUCHE/ REAR LEFT) Ø 15X22X38 LITE/ START/ PILOT/ BIGY MX125-150
 04 N° YC110-11-041 (ARRIÈRE DROITE/ REAR RIGHT) Ø 15X22X29 LITE/ START/ PILOT/ BIGY MX125-150 € 5

**ENTRETOISE DE ROUE MOBSTER**

MOBSTER WHEEL SPACER

- N° FB13-15X22X19-W (AVANT DROITE) € 6
 N° FB13-15X22X23-W (ARRIÈRE DROITE)
 N° FB13-15X22X28-W (AVANT GAUCHE)
 N° FB13-15X22X34-W (ARRIÈRE GAUCHE) € 22
 N° KFB13-15

ENTRETOISE CENTRALE DE MOYEU

CENTRAL HUB SPACER

- 05 N° YC110-0601-02 (CENTRAL AVANT/ FRONT) Ø 16x22x44
 05 N° YC110-0601-021 (CENTRAL AVANT/ FRONT) Ø 16x21x53
 05 N° YC110-0601-022 (CENTRAL AVANT/ FRONT) Ø 15x22x43
 05 N° YC110-1101-03 (INT, ARRIÈRE/ INNER REAR) Ø 16x21x84
 05 N° YC110-1101-04 (INT, ARRIÈRE/ INNER REAR) Ø 16X21X64
 05 N° YC110-1101-05 (INT, ARRIÈRE/ INNER REAR) Ø 16x21x59
 05 N° YC110-1101-06 (INT, ARRIÈRE/ INNER REAR) Ø 16x21x74

ENTRETOISE SP3 2019 (TÉ 170 mm)

WHEEL SPACER

- 04 N° YC110-0609-08 (AVANT DROITE/ FRONT RIGHT)
 04 N° YC110-0610-08 (AVANT GAUCHE/ FRONT LEFT) € 7

**KIT ENTRETOISE DE ROUE FIXE POUR MOYEU INJECTÉ**

WHEEL SPACER KIT FOR INJECTED HUB

€ 5

- N° YC110-0635-01 (AVANT/ FRONT) LITE/ START/ PILOT/ BIGY125/ BIGY150MX/ SUPERMOTO/ MINI GP € 29
 N° YC110-1126-01 (ARRIÈRE / REAR) LITE/ START/ PILOT/ BIGY125/ BIGY150MX/ SUPERMOTO/ MINI GP € 29





**ROBERTO ROLFO - 2019 AND 2020 EWC WORLD CHAMPION WINNER
OFFICIAL YCF AMBASSADOR**



↙ PNEUS TIRES



CHAMBRE À AIR RENFORCÉE 4mm
REINFORCED TUBE 4mm

- 01 N° CHAMBRE10RENF (Ø 10" FRONT-REAR/ AV,-AR,) € 13
- 01 N° CHAMBRE12RENF (Ø 12" FRONT-REAR/ AV,-AR,) € 13
- 01 N° CHAMBRE14RENF (Ø 14" AV./ FRONT) € 13
- 01 N° CHAMBRE14ARRENF (Ø 14" AR./ REAR) € 16
- 01 N° CHAMBRE17RENF (Ø 17" AV./ FRONT) € 16

CHAMBRE À AIR STANDARD
STANDARD TUBE

- 01 N° CHAMBRE10-2,5 (Ø 10" POUR/ FOR YCF 50) € 10
- 01 N° CHAMBRE12AV (Ø 12" AVANT/ FRONT) € 13
- 01 N° CHAMBRE16AR € 19
- 01 N° CHAMBRE17-2 (Ø 17" AV. AR./ FRONT-REAR) € 16
- 01 N° CHAMBRE19AV € 19

FOND JANTE
TIRE LINING

- 02 N° YC110-11-01 (ROUE/ WHEEL 10/12")
- 02 N° YC110-06-01 (ROUE/ WHEEL 14")
- 02 N° YC110-06-07 (ROUE/ WHEEL 17") € 2



BOUCHON DE VALVE CNC
NOIR/ BLEU/ ROUGE/ VERT/ ORANGE
VALVE CAP SET
BLACK/ BLUE/ RED/ GREEN/ ORANGE

N° TVC-COLOR € 5



PNEU AVANT CROSS 2,50/10
FRONT MX TIRE IN 2,50/10

N° 250/10 € 29



PNEU AVANT CROSS EN 60/100/12
FRONT MX TIRE IN 60/100/12

N° 60/100/12 € 32



PNEU ARRIÈRE CROSS EN 90/100/14
REAR MX TIRE IN 90/100/14

N° 90/100-14P398 € 65



PNEU ARRIÈRE CROSS EN 3,00/10
REAR MX TIRE IN 3,00/10

N° 300/10 € 36



PNEU ARRIÈRE CROSS EN 80/100/12
REAR MX TIRE IN 80/100/12

N° 300/12 € 32



PNEU AVANT CROSS EN 70/100/17
FRONT MX TIRE IN 70/100/17

N° 70/100-17P397 € 45



PNEU AVANT CROSS EN 60/100/14
FRONT MX TIRE IN 60/100/14

N° 60/100/14 € 32



PNEU ARRIÈRE CROSS EN 90/100-16P52
REAR MX TIRE IN 90/100-16P52

N° 90/100-16P52 € 65



PNEU 90/90/10
TIRE 90/90/10

N° 90/90/10 € 45



PNEU AVANT CROSS EN 70/100-19P51
FRONT MX TIRE IN 70/100-19P51

N° 70/100-19P51 € 59

ARRO™



10

PNEU ARRO® SPIDER CROSS EN 300/10
SPIDER ARRO® TIRE 300/10

Nº 300/10 ARRO

€ 40

ARRO™



12

PNEU ARRO® SPIDER CROSS AVANT EN 60/100/12
SPIDER ARRO® TIRE FRONT 60/100/12

Nº 60/100/12 ARRO

€ 39

ARRO™



12

PNEU ARRO® SPIDER CROSS ARR, EN 80/100/12
SPIDER ARRO® TIRE REAR 80/100/12

Nº 80/100/12ARRO

€ 55

ARRO™



14

PNEU ARRO® SPIDER CROSS AVANT EN 60/100/14
SPIDER ARRO® TIRE FRONT 60/100/14

Nº 60/100/14ARRO

€ 49

ARRO™



14

PNEU ARRO® SPIDER CROSS ARR, EN 90/100/14
SPIDER ARRO® TIRE TRAR 90/100/14

Nº 90/100/14 ARRO

€ 59

ARRO™



17

PNEU ARRO® SPIDER® CROSS AVANT EN 70/100/17
SPIDER ARRO® TIRE FRONT 70/100/17

Nº 70/100/17 ARRO

€ 55

17

PNEU AVANT SUPERMOTARD KENDA® K711
FRONT SUPERMOTO TIRE KENDA K711

Nº 110/70-17K711

€ 99

ARRO™



17

PNEU ARRIÈRE SUPERMOTARD KENDA® K711
REAR SUPERMOTO TIRE KENDA K711

Nº 130/70-17K711

€ 109

REPOSE-PIEDS & SABOTS FOOT PEGS & SKID PLATES



BARRE DE REPOSE-PIED
FOOT PEGS MOUNT BAR

N° YC110-0901-01 (GAMME START/ START RANGE) € 29



**RÉSERVOIR RÉCUPERATEUR DE LIQUIDE
AVEC SEPARATEUR HUILE/ ESSENCE**
CATCH CAN WITH SEPARATOR OIL/ GAZ

N° YC110-0816-02 € 39



PLATINE RÉGLABLE AVEC REPOSE PIED SUPERMOTARD
SUPERMOTARD ADJUSTABLE FOOT PEGS KIT

N° YC110-0919-01 € 69



SABOT MOTEUR ACIER
STEEL SKID PLATE

N° YC110-202-01 (ACIER/ STEEL 88/125/140) € 39
N° YC110-0905-02 (ACIER/ STEEL BIGY 190ZE) € 49



SABOT POUR FACTORY
SKID PLATE FOR FACTORY

N° YC110-207-12 (LITE/START/PILOT) (kickstart model)
N° YC110-207-03 (FACTORY SP1)
N° YC110-207-04 (FACTORY SP2)
N° YC110-207-05 (FACTORY SP3) € 49



**SABOT RÉCUPERATEUR HUILE SUPERMOTARD EN FIBRE
DE VERRE BLANC/ NOIR**
RACE BELLY PAN WHITE/ BLACK

N° YC110-202-03-WH € 79
N° YC110-202-03-BK € 79
(Adaptable sur toute la gamme YCF/ fit on all YCF range)



JEU DE REPOSE-PIED ALUMINIUM NOIR/ BLEU/ ROUGE/ VERT/ ORANGE
ALUMINUM FOOT PEGS BLACK/ BLUE/ RED/ GREEN/ ORANGE

N° RPALU-COLOR € 69

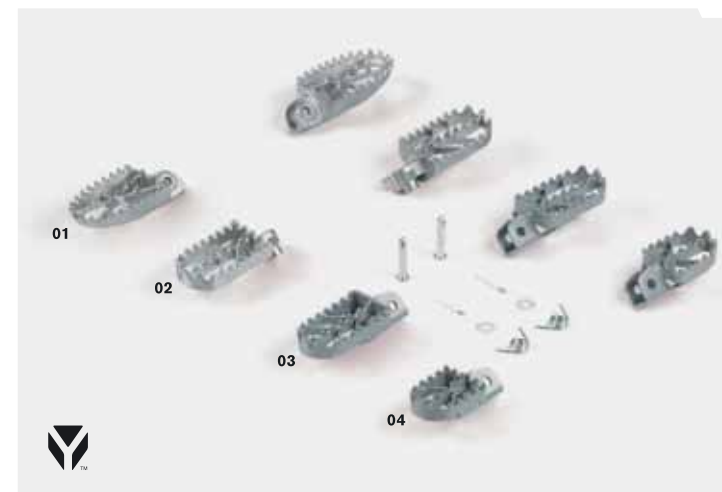

JEU DE REPOSE-PIED
FOOT PEGS SET

01 N° YC110-0902/05 (INOX LARGE/ LARGE STAINLESS STEEL)
02 N° YC110-0902/04 (INOX/ STAINLESS STEEL) € 49
03 N° YC110-0902/17 (ACIER/ STEEL)
04 N° YC110-0902/06 (SUPERMOTO) € 29



KIT COMPLET PROTECTION TEFLON SUPERMOTO
SUPERMOTO TEFLON PROTECTION SET

N° KS1 € 59



KIT PATIN TEFLON SUPERMOTO
SUPERMOTO TEFLON SET

N° KS4 € 35



KIT BOCAL RÉCUPÉRATEUR HUILE ET ESSENCE SUPERMOTO
SUPERMOTO OIL AND FUEL CATCH CAN

N° KS3 € 29

↓ SÉLECTEURS SHIFT LEVERS



SÉLECTEUR ALUMINIUM CNC AVEC DÉPORT POUR AXE SÉLECTEUR COURT
NOIR/ BLEU/ ROUGE/ ORANGE/ VERT
ALUMINUM CNC GEAR LEVER WITH EXTENSION FOR SHORT LEVER SHAFT
BLACK/ BLUE/ RED/ ORANGE/ GREEN

01 N° STMD-COLOR € 39

SÉLECTEUR FORGÉ NOIR/ BLEU/ ROUGE/ ORANGE/ VERT
FORGED GEARSHIFT BLACK/ BLUE/ RED/ ORANGE/ GREEN

02 N° 24700-01-COLOR € 29



KICK ACIER ORIGINE
ORIGINAL STEEL KICKSTARTER

01 N° 43451/152FMH (Ø 13mm)
01 N° 43452/152FMH (Ø 16mm) € 19

KICK ACIER RENFORCÉ
REINFORCED KICKSTARTER

02 N° YC140-27500SI (Ø 13mm)
02 N° YC140-27600SI (Ø 16mm) € 50

RESSORT/ BILLE/ VIS POUR KICK
BALL, SPRING, AND SCREW FOR KICKSTARTER

03 N° KVK € 3



SÉLECTEUR ACIER REPLIABLE
FOLDABLE STEEL SHIFT LEVER

01 N° 24700/152FMI/3V (AVEC DÉPORT/ WITH EXT.)
01 N° 24700/152FMH/02 (190 ZONGSHEN ENGINE)
02 N° 24700/152FMH/03 € 15

SÉLECTEUR ACIER REPLIABLE ET RÉGLABLE
FOLDABLE & ADJUSTABLE STEEL SHIFT LEVER

03 N° 24700-D (AVEC DÉPORT/ WITH EXT.)
04 N° 24700-SD € 17

KIT CHAÎNE & TRANSMISSION

SPROCKET KITS & TRANSMISSIONS

SPECIAL PARTS
YCF RACING



41  45

COURONNE ACIER Ø INTÉRIEUR 75 - ENTRAXE COURONNE 92 - 5 TROUS DE FIXATION POUR FACTORY 2016-24

STEEL SPROCKET INNER Ø 75 - SPROCKET CENTER TO CENTER DISTANCE 92 - 5 HOLES FIXATION FOR FACTORY 2016-24

N° YC110-11-062/41 (41 DENTS/ TEETH)
N° YC110-11-062/45 (45 DENTS/ TEETH)

€ 17



01

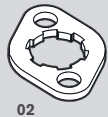

02



03

PIGNON SORTIE BOÎTE & PLAQUE PIGNON
COUNTERSHAFT SPROCKET & SPROCKET PLATE

01 N° 22711/152FMI14 (Ø 20 PIGNON 14 DENTS/ SPROCKET 14 TEETH)
01 N° 22711/152FMI15 (Ø 20 PIGNON 15 DENTS/ SPROCKET 15 TEETH)
02 N° 22712/152FMH (Ø 17 PLAQUE PIGNON/ SPROCKET PLATE)
02 N° 22712/152FMI (Ø 20 PLAQUE PIGNON/ SPROCKET PLATE)
03 N° RS35/10T (PIGNON 10 DENTS/ SPROCKET 10 TEETH) YCF 50E
03 N° RS35/10T-01 (PIGNON 10 DENTS/ SPROCKET 10 TEETH) W88 2020-21
03 N° RS35-11T-01 (PIGNON 420 11 DENTS / SPROCKET 11 TEETH 420) W88 2022-24

€ 9

€ 6

€ 15

€ 15

€ 15

SPECIAL PARTS
YCF RACING



CHAÎNE RENFORCÉE 420 116 MAILLONS BLEUE/ ROUGE/ VERTE/ JAUNE/ ORANGE
REINFORCED CHAIN 420 116 LINKS BLUE/ RED/ GREEN/ YELLOW/ ORANGE

N° 420DX-116T-COLOR

€ 25

SPECIAL PARTS
YCF RACING



39  45



 60

COURONNE ACIER Ø INTÉRIEUR 75 - ENTRAXE COURONNE 92

STEEL SPROCKET INNER Ø 75 - SPROCKET CENTER TO CENTER DISTANCE 92

01 N° YC110-11-06/39 (39 DENTS/ TEETH)

€ 17

01 N° YC110-11-06/41 (41 DENTS/ TEETH)

€ 17

01 N° YC110-11-06/45 (45 DENTS/ TEETH)

€ 17

YC110-11-06/47 (47 DENTS / TEETH)

€ 17

02 N° YC110-11-05/60 (60 DENTS/ TEETH - YCF 50E/ W88)

€ 29

SPECIAL PARTS
YCF RACING



PIGNON SORTIE BOÎTE ANTI BOUE Ø 17
ANTI MUD COUNTERSHAFT SPROCKET Ø 17

N° 22711/152FMZ13 (13 DENTS/ TEETH)
N° 22711/152FMZ14 (14 DENTS/ TEETH)
N° 22711/152FMZ15 (15 DENTS/ TEETH)
N° 22711/152FMZ16 (16 DENTS/ TEETH)
N° 22711/152FMZ17 (17 DENTS/ TEETH)
N° 22711/152FMZ18 (18 DENTS/ TEETH)
N° 420H/10T (10 DENTS/ TEETH) (YCF 50A)

**NEW
2024**

€ 9

€ 10

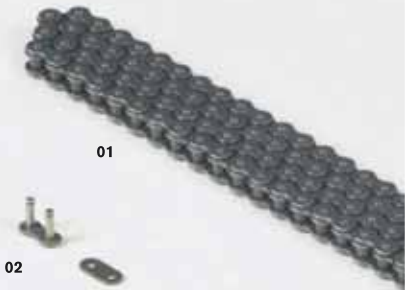

01

02

CHAÎNE 420 ET RS35
CHAIN 420 AND RS35

01 N° 420H-104T (104 MAILLONS/ LINKS) € 17

01 N° 420H-110T (110 MAILLONS/ LINKS) € 17

01 N° 420H-116T (116 MAILLONS/ LINKS BIGY) € 17

01 N° 420DX-120T (120 MAILLONS/ LINKS BIGY 16-19) € 35

01 N° RS35-114T (114 MAILLONS/ LINKS 50E) € 19

ATTACHE RAPIDE

CHAIN JOINING LINK

02 N° AR-420

02 N° AR-35 (YCF 50E)

€ 2,5



NEW
2024

32 33 34 35 36 37 39 41 43 45 47

COURONNE ALU. TAILLÉE DANS LA MASSE DISPONIBLE EN 32, 33, 34, 35, 36, 37, 39, 41, 43, 45, 47 DENTS NOIRE/ BLEUE/ ROUGE/ VERTE/ ORANGE
Ø INTÉRIEUR 75 - ENTRAXE COURONNE 92

BILLET ALUMINUM SPROCKET AVAILABLE IN 32,33, 34, 35, 36, 37, 39, 41, 43, 45, 47 TEETH
BLACK/ BLUE/ RED/ GREEN/ ORANGE
INNER Ø 75 - SPROCKET CENTER TO CENTER DISTANCE 92

N° CA06R+TEETH-COLOR
(YCF50A - LITE - START - PILOT - SM)

€ 39

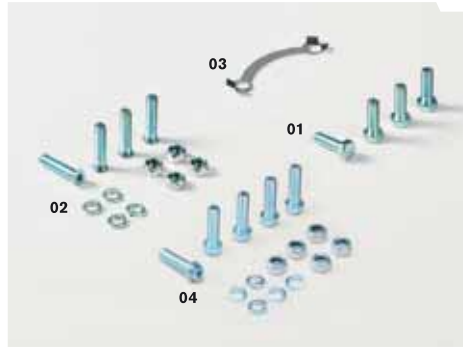

KIT VIS COURONNE
SCREW SET FOR SPROCKET

- 01 N° KVC € 5
- 02 N° KVC-1 (TÊTE FRAISÉE/ FLAT HEAD) € 5
- 04 N° KVC-2 (KIT VIS PLATES/ SCREW KIT FLAT HEAD) € 6

BLOC COURONNE
BLOCK SPROCKET

03 N° YC110-11-03

€ 5



TENDEUR CHAÎNE CNC NOIR/ BLEU/ ROUGE/ VERT/ ORANGE
CNC AXLE BLOCK BLACK/ BLUE/ RED/ GREEN/ ORANGE

- 01 N° TC07-COLOR (Ø 15) (POUR BRAS ACIER/ FOR STEEL SWING ARM) € 5
- 02 N° TC12-COLOR (POUR BRAS ALU/ FOR ALU SWING ARM - 2011-2024) € 15
- 03 N° TC-COLOR (Ø 12 RED OR BLACK ONLY/ ROUGE OU NOIR SEULEMENT) € 19



39 41 43 45 47

COURONNE ALU, TAILLÉE DANS LA MASSE - 5 TROUS DE FIXATION POUR FACTORY 2016-2024 - DISPONIBLE EN 39, 41, 43, 45, 47 DENTS NOIRE/ BLEUE/ ROUGE/ VERTE/ ORANGE - Ø INTÉRIEUR 75 - ENTRAXE COURONNE 92

BILLET ALUMINUM SPROCKET - 5 HOLE FIXATION FOR FACTORY 2016-2024 - AVAILABLE IN 39, 41, 43, 45, 47 TEETH BLACK/
BLUE/ RED/ GREEN/ ORANGE - INNER Ø 75 - SPROCKET CENTER TO CENTER DISTANCE 92

N° CA16R+TEETH-COLOR
(FACTORY-BIGY)

€ 39

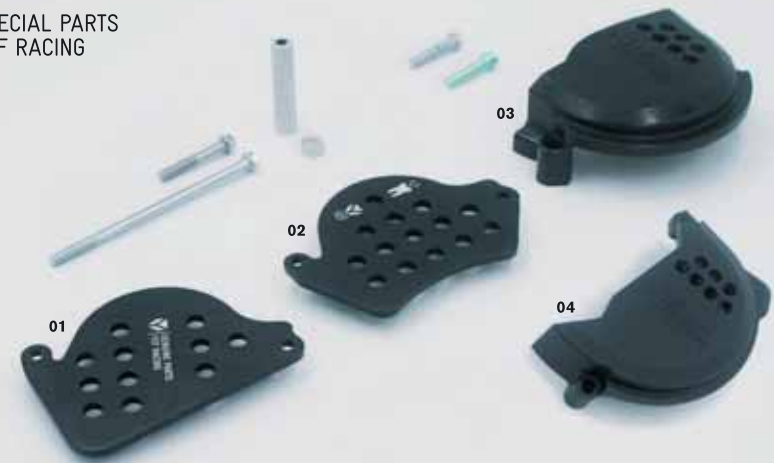

PROTECTION PIGNON SORTIE BOÎTE (VIS & ENTRETOISES INCLUSES)
COUNTERSHAFT SPROCKET GUARD (SCREWS & SPACERS INCLUDED)

- 01 N° YC110-253BK (PILOT - FACTORY) € 15
- 02 N° YC110-251BK (START) € 15
- 03 N° YC110-1803-BK (ELECTRIC START ENGINE) (START SE 88/ START SE 125/ PILOT 150 E/ BIGY 150 FACTORY E) € 19
- 04 N° YC110-1803-02-BK (LITE /START 125/PILOT 125/BIGY125-150/BIGY190 DAYTONA) € 15



CLÉ À BOUGIE
SPARK PLUG REMOVAL TOOL

01 N° CB € 6

ARRACHE VOLANT 3 EN 1
ADAPTABLE SUR TOUS LES MOTEURS DE MINI
FLYWHEEL REMOVER 3 IN 1
SUITABLE FOR ALL MINI BIKES ENGINES

02 N° ARRACHE-1 € 15

OUTIL POUR DÉMONTER NOIX EMBRAYAGE ET ÉPURATEUR
CLUTCH TOOL

03 N° OUTIL € 15

DÉRIVE CHÂÎNE PROFESSIONNEL
PROFESSIONAL CHAIN TOOL

04 N° DERIVE-1 € 25

CLÉ À RAYONS
SPROKE WRENCH

05 N° CLEARAYON-02 € 7

JEU DE CALES MOTEUR
ENGINE FEELER GAUGES

06 N° JCM-1 € 7

DÉMONTE PNEU EN CUILLÈRE
SPOON TIRE LEVER

07 N° DEMONT-1 € 12

OUTIL RÉGLAGE SOUPAPES
VALVE ADJUSTMENT TOOL/ WRENCH

10 N° YC110-2410-01 € 9

FREIN FILET - ROUGE : FORT/ BLEU : MOYEN
THREADLOCKER - RED: STRONG/ BLUE: MEDIUM

08 N° FF271 (STRONG/ FORT)
09 N° FF242 (MEDIUM/ MOYEN) € 16

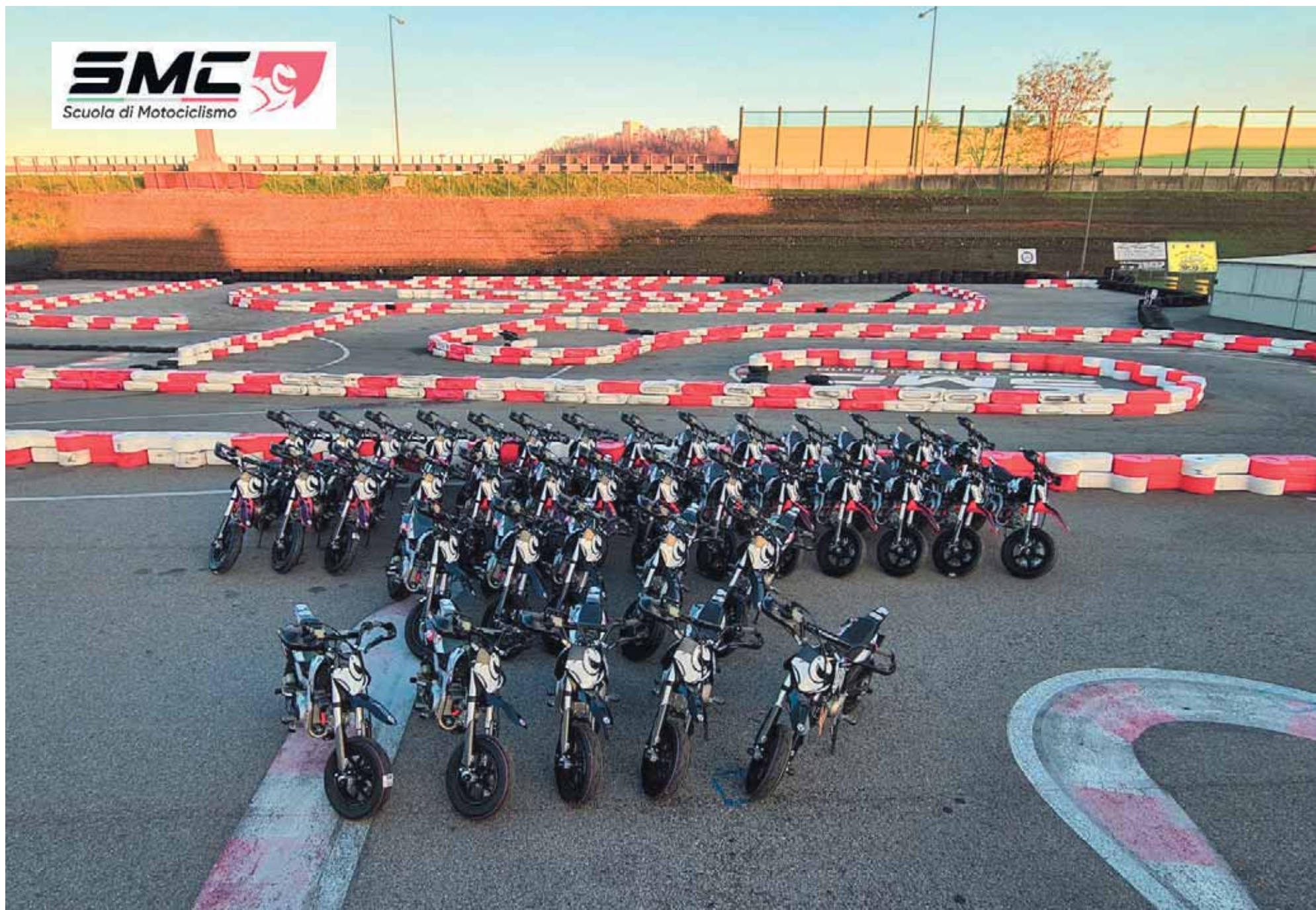



KIT DÉPART ENGI®
ENGI® LAUNCH CONTROL

N° ENGIHKF-BK

€ 59



BAGUE/ JOINT SPI/ CACHE POUSSIÈRE FOURCHE
FORK RING/ OIL SEAL/ DUST COVER

01 N° EF03-0027-BC (INFERIEURE/ LOWER)

€ 12

02 N° EF03-0005 (SUPÉRIEURE/ UPPER)

€ 12

03 N° EF03-0009-01 (ENGI®)

€ 9

04 N° EF03-0011-01 (ENGI®)

€ 12

(VENDU À L'UNITÉ/ SELL BY UNIT)



FOURCHE ENGI® RÉGLABLE COMPRESSION DÉTENTE AVEC CORPS ALUMINIUM ET TRAITEMENT DU TUBE INF.
ENGI® FORK WITH ADJUSTABLE COMPRESSION & REBOUND

N° ENGI2-800-GY (800mm)

€ 649



FOURCHE ENGI® RÉGLABLE COMPRESSION DÉTENTE
ENGI® FORK WITH ADJUSTABLE COMPRESSION & REBOUND

N° ENGI2-735-GY (735mm)

€ 599



OUTIL CLÉ EN T ENGI®
ENGI® T-HANDLE WRENCH TOOL

01 N° ENGI-PDR

€ 59

OUTIL DÉMONTAGE BOUCHON (du haut) ENGI®
ENGI® PLUG REMOVAL TOOL

02 N° ENGI-FCW

€ 49

OUTIL DE TIGE INTÉRIEURE DE FOURCHE ENGI®
ENGI® INTERNAL FORK STEM TOOL

03 N° ENGI-DAT

€ 49



ENGI®

AMORTISSEUR ENGI® RÉGLABLE DÉTENTE
ENGI® SHOCK ABSORBER ADJUSTABLE REBOUND

- | | |
|--|-------|
| N° YC110-0404-65 (270mm START) | € 219 |
| N° YC110-0404-66 (310mm PILOT 2013-19/ SM 2013-24) | € 279 |
| N° YC110-0404-61 (330mm SP2/ PILOT 20-24) | € 279 |
| N° YC110-0404-63 (335mm SP3) | € 279 |
| N° YC110-0404-69 (355mm BIGY) | € 299 |



KIT RÉFECTION INTERIEUR AMORTISSEUR
ENGI® SHOCK INTERNAL REPAIR KIT

N° ES01-000B € 69



KIT RÉFECTION ENTRETOISE AXE AMORTISSEUR
ENGI® SHOCK SPACER KIT

N° ES01-000C € 25



FACTORY

SPECIAL PARTS
YCF RACING

01



- 01 **KIT ROUE SUPERMOTO YCF/ YCF SUPERMOTO WHEEL SET** PAGE 97
N° YC110-0626-01-BK
- 02 **PROTÈGE LEVIER TYPE MOTO GP/ MOTOGP STYLE LEVER PROTECTION** PAGE 76
N° YC110-14-072BK
- 03 **POIGNÉE CAOUTCHOUC/ RUBBER GRIPS** PAGE 79
N° PPC011+COLOR
- 04 **MAÎTRE CYLINDRE FREIN AVANT/ FRONT BRAKE MASTER CYLINDER** PAGE 86
N° YC110-0507-01
- 05 **GUIDON/ HANDLEBAR** PAGE 77
N° GALOW+COLOR

**PIECES
USINES
CNC
ALUMINIUM
MULTICOLORES**

MULTICOLOR
FACTORY
CNC
ALUMINIUM
PARTS



PIECES RACING SUPERMOTARD SUPERMOTARD RACING PARTS

FACTORY
SPECIAL PARTS
YCF RACING



- | | |
|---|---------|
| 01 BÉQUILLE ROUE ARRIÈRE/ REAR STAND
N° STAND1MOTO-04 | PAGE 59 |
| 02 VALVE PRISE AIR/ FUEL VENT VALVE
N° YC125-0704+COLOR | PAGE 85 |
| 03 DONUTS/ GRIP DONUTS
N° DONUTZ-02+COLOR | PAGE 79 |
| 04 PASSE DURITE FREIN AVANT/ STEEL BRAKE LINE RETAINER
N° YC110-0403-06+COLOR | PAGE 74 |

ENGINE PARTS

PIÈCES MOTEUR

MOTEURS DAYTONA®/ DAYTONA® ENGINES	118
MOTEURS/ ENGINES	119
KITS MOTEUR/ ENGINE KITS	120
EMBAYAGE/ CLUTCH	123
CARBURATEURS/ CARBURETORS	125
FILTRES À AIR/ AIR FILTERS	127
ÉCHAPPEMENTS/ EXHAUSTS	128
FILTRES & RADIATEURS/ FILTERS & COOLERS	131
ALLUMAGE/ IGNITION	132
PIÈCES RACING DAYTONA®/ DAYTONA® RACING PARTS	134
PIÈCES D'ORIGINE DAYTONA®/ DAYTONA® PARTS	135



TM

MOTEURS ENGINES

DAYTONA®

DAYTONA® EST UNE SOCIÉTÉ JAPONNAISE SPÉCIALISÉE DANS LE DÉVELOPPEMENT ET LA FABRICATION DE PIÈCES HAUTE PERFORMANCE MOTOS DEPUIS 1972. L'ENTREPRISE EST UN LEADER INTERNATIONAL DE L'INDUSTRIE DES PIÈCES RACING.
(DÉTAIL DES PIÈCES À PARTIR DE LA PAGE 130)

DAYTONA® IS A JAPANESE COMPANY SPECIALIZING IN HIGH PERFORMANCE MOTORCYCLE PARTS. THEY HAVE BEEN A LEADER IN THE MOTORCYCLE INDUSTRY SINCE 1972. DAYTONA PROVIDES MOTORCYCLE RACING PARTS, AS WELL AS OE MOTORCYCLE PARTS, TO THE ENTIRE INTERNATIONAL MARKETPLACE. (SEE PARTS DETAILS STARTING ON PAGE 130)

**NEW
2024**

CARTER RENFORCÉ
REINFORCED CRANKCASE



FEATURING

DÉCOMPRESSEUR AUTOMATIQUE
DECOMPRESSION SYSTEM



DAYTONA



ANIMA® 2.0 MX

MOTEURS DAYTONA® ANIMA® 2,0

DAYTONA® ANIMA® 2.0 ENGINES

№ 88026 (150cc FSM)
№ 87615 (190cc, 4 SPEEDS)
№ 81244 (190cc, SYS, 4 SPEEDS)
№ 88025 (ANIMA® 160cc, FSM, 4 SPEEDS)
№ 88616 (190cc, 5 SPEEDS)

€ 1199
€ 1299
€ 1349
€ 1299
€ 1349



MOTEUR DAYTONA® 190cc FE DÉMARREUR ÉLECTRIQUE 5 VITESSES

DAYTONA® 190cc FE ENGINE ELECTRIC START 5 SPEEDS

№ 88392

€ 1399

ZONGSHEN



MOTEUR ZONGSHEN® FIDDY

ZONGSHEN® FIDDY ENGINE

№ MOTEUR110-G
№ MOTEUR125-G
№ MOTEUR155-G

€ 499
€ 599
€ 749

MOTEUR 50 YCF 2012-2020 AUTOMATIC
YCF 50 ENGINE 2012-2020 AUTOMATIC

01 N° MOTEUR50-01-GY € 429

MOTEUR 125 À DÉMARREUR
125 4 SPEED SEMI-AUTOMATIC ENGINE ELECTRIC START

02 N° MOTEUR125SELE-01 € 499

MOTEUR 88 À DÉMARREUR
88 4 SPEED SEMI-AUTOMATIC ENGINE ELECTRIC START

03 N° MOTEUR88ELE-02 € 499

MOTEUR 88 4 VITESSES SEMI-AUTOMATIC
88 4 SPEED SEMI-AUTOMATIC ENGINE

04 N° MOTEUR88 € 399

MOTEUR 125 POINT MORT
125 NEUTRAL ENGINE

05 N° MOTEUR125P € 399

MOTEUR 125 4 VITESSES SEMI-AUTOMATIC
125 4 SPEED SEMI-AUTOMATIC ENGINE

06 N° MOTEUR125SEMI € 429

MOTEUR 150 TYPE KLX
150 ENGINE TYPE KLX

07 N° MOTEUR150-2 € 749

MOTEUR 150-3
150-3 ENGINE

08 N° MOTEUR150-3 € 579

MOTEUR 150 TYPE CRF
150 ENGINE TYPE CRF

09 N° MOTEUR150-5 € 679

MOTEUR 150 YX DÉMARREUR ÉLECTRIQUE
150 YX ENGINE ELECTRIC START

10 N° MOTEUR150-3E € 599

MOTEUR 155 ZHONGSHEN
155 ENGINE TYPE ZS

07 N° MOTEUR155ZS € 649



10



KITS MOTEUR & PIÈCES **ENGINE KITS & PARTS**



CHAÎNE DE DISTRIBUTION
TIMING SPROCKET

N° D00F012 (84 MAILLONS POUR 125cc POINT MORT ET SEMI-AUTOMATIQUE/ 84 TEETHS FOR 125cc NEUTRAL START AND SEMI-AUTOMATIC) **€ 25**
 N° 14350 (88 MAILLONS POUR 140cc lifan/ 88 TEETHS FOR 125cc lifan) **€ 25**
 N° 14350/152FMI (90 MAILLONS POUR 125/ 140/ 150 CRF/ 90 TEETHS FOR 125/ 140/ 150 CRF TYPE) **€ 25**
 N° 210F012 (POUR YX 150/ 160 TYPE KLX/ FOR 150/ 160 YX KLX TYPE) **€ 39**



BOUCHON CARTER ALUMAGE YCF CNC
NOIR/ BLEU/ ROUGE/ VERT/ ORANGE
ALUMINIUM CAP BIG VIEW HOLE FOR YCF COVER
BLACK/ BLUE/ RED/ GREEN/ ORANGE

N° YC110-2014-01-COLOR

€ 9



CARTER D'ALLUMAGE POUR DÉMARRER ÉLECTRIQUE
IGNITION COVER ELECTRIC START

01 N° 12301-D083-000189 **€ 39**
 02 N° 90204-D083-000 **€ 4**



NOUVEAU CARTER D'ALLUMAGE YCF (Pour démarrage au kick)
NEW YCF IGNITION COVER (kickstart only)

01 N° YC110-2004-01-GY (GRIS/GREY) **€ 49**
 02 N° YC110-2004-01-BK (NOIR/BLACK) **€ 49**
 03 N° YC110-2004-01-MG (MAGNESIUM) **€ 49**



CARTER D'ALLUMAGE
IGNITION COVER

- 01 N° 11411/152FMH (CARTER D'ALLUMAGE/ IGNITION COVER) € 37
- 02 N° 11411/152FMH-MG (CARTER D'ALLUMAGE/ IGNITION COVER) € 45
- 03 N° 11411/152FMH-BK (CARTER D'ALLUMAGE/ IGNITION COVER) € 45
- 04 N° 11419/152FMH (JOINT CARTER ALLUMAGE/ IGNITION COVER GASKET) € 7
- 05 N° A00-8-1(CARTER ALLUMAGE LITE 88/125) € 37

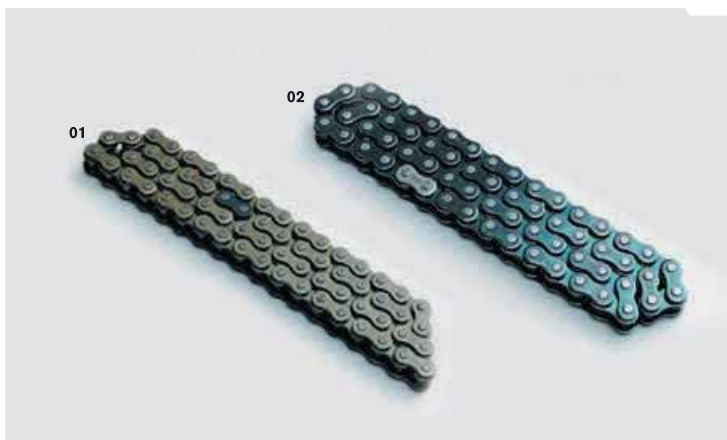

CHAÎNE DE DÉMARREUR
STARTER CHAIN

- 01 N° 2141B-IA29-0000 POUR MOTEUR/ FOR ENGINE 88-125 SE € 12
- 02 N° 100061493 POUR MOTEUR/ FOR ENGINE 190 ZONGSHEN® € 19



KIT PISTON
PISTON KIT

- N° KPC/39-13 (YCF 50) € 55
- N° KPC/44-13 (YCF 50A 2012-24) € 55
- N° KPC/47-13 (88 CC Ø 46,5 AXE 13) € 55
- N° KPC/52,5-13 (88/107/120/125 CC Ø 52,5 AXE 13) € 55
- N° KPC/52,5-14 (120/125 CC Ø 52,5 AXE 14) € 55
- N° KPC/54-14 (120/125 CC Ø 54 AXE 14) € 55
- N° KPC/55-15 (140 LIFAN Ø 55 AXE 15) € 55
- N° KPC/56-13 (140/150 YX TYPE CRF Ø 56 AXE 13) € 55
- N° KPC/56,5-15 (150 LIFAN Ø 56,5 AXE 15) € 55
- N° KPC/60-13 (150-160 YX TYPE KLX Ø 60 AXE 13) € 59

JEU DE SEGMENTS SEUL
PISTON RINGS SET ONLY

- N° 13300F (88 CC Ø 46,5) € 20
- N° 13300/152FMI (107-125 CC Ø 52,5) € 20
- N° 13300/152FMH (125-138 CC Ø 54) € 20
- N° 13300 (140 CC Ø 55) € 20
- N° 208J013 (140-150 CC Ø 56) € 20
- N° 210J013 (150 CC Ø 60) € 19

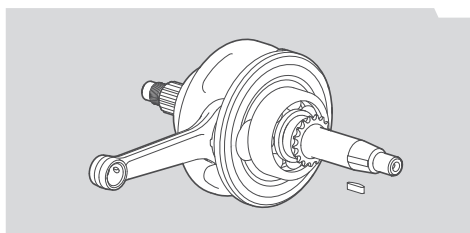

VILEBREQUIN
CRANKSHAFT

- N° 13100/152FMI (125 LIFAN AXE PISTON 14) € 99
- N° 208J000 (125/140 YX AXE PISTON 13) € 119
- N° 13100 (140 LIFAN AXE PISTON 15) € 119
- N° 216J000 (150 CRFAXE PISTON 13) € 139
- N° 2104J000 (150 KLX) € 119
- N° 2043J000 (125 POINT MORT) € 119



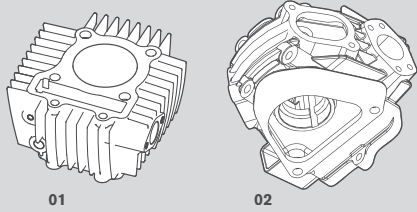

CYLINDRES & CULASSES
CYLINDERS & CYLINDER HEADS

- 01 N° 12110/152FMI (125 LIFAN 52,5mm)
- 01 N° 12112 (140 LIFAN 55mm)
- 01 N° 206A038 (125 YX 52,5mm)
- 01 N° 2081A038 (140 YX 56mm)
- 01 N° 208A038 (150 YX TYPE CRF)
- 01 N° 210A038 (150 YX TYPE KLX)
- 01 N° 204A038 (125 YX 54mm) € 119

- 02 N° 206A000 (125 YX)
- 02 N° 208A000 (140/150 YX TYPE CRF)
- 02 N° 210A000 (150/160 YX TYPE KLX) € 209

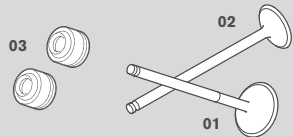

SOUPAPE D'ADMISSION
INLET VALVE

- 01 N° 206F045 (125 YX Ø 24)
- 01 N° 14710/152FMI (125, 140, 150 Ø 27)
- 01 N° 210F045 (KLX) € 19

- 01 N° 221F045 (KLX 4V) € 39

SOUPAPE D'ÉCHAPEMENT
EXHAUST VALVE

- 02 N° 206F039 (125 YX Ø 21)
- 02 N° 14720/152FMI (125, 140, 150 Ø 23)
- 02 N° 210F039 (KLX) € 19

- 02 N° 221F039 (KLX 4V) € 39

JOINT QUEUE SOUPAPE
VALVE STEM SEAL

- 03 N° 14730/152FMH € 5

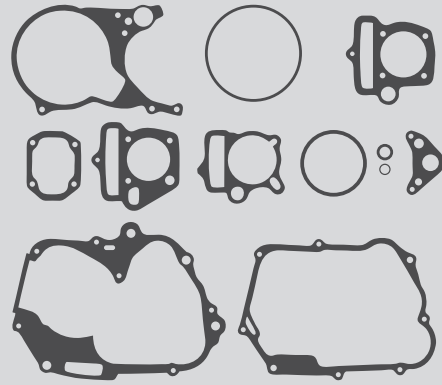

POCHETTE JOINTS COMPLÈTE
COMPLETE GASKET SET

- N° PJCM50 (50S YCF 2010-2011) € 39
- N° PJCM50-2 (50A YCF 2012-2022) € 39
- N° PJCM88 (88 CC) € 39
- N° PJCMSE (START F88SE/ F125SE) € 39
- N° PJCM125 (125 CC) € 49
- N° PJCM140 (140 CC) € 39
- N° PJCM150CRF (150 CC) € 39
- N° PJCM150KLX (150 CC TYPE KLX) € 45
- N° PJCM150-3E (PILOT F150E 2022-23) € 45



POCHETTE JOINTS HAUT MOTEUR
GASKET SET TOP END

- N° PJHM50 (50S YCF 2010-2011) € 19
- N° PJHM50-2 (50A YCF 2012-2022) € 19
- N° PJHM88 (88 CC) € 19
- N° PJHM125 (125 CC) € 29
- N° PJHM140 (140 CC) € 25
- N° PJHM150CRF (150 CC) € 25
- N° PJHM150KLX (150 CC TYPE KLX) € 25
- N° PJHM150-3E (PILOT F150E 2022-23) € 25

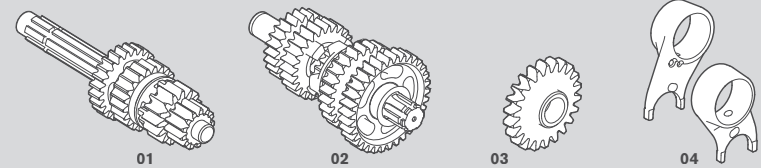

ARBRE BOÎTE PRIMAIRE COMPLET Ø 12 CÔTÉ ALLUMAGE Ø 14 CÔTÉ EMBR. LIFAN LONG. 155mm/ YX LONG. 153,5mm
COMPLETE MAIN BOX SHAFT Ø 12 IGNITION SIDE & Ø 14 CLUTCH SIDE LIFAN LENGTH 155mm/ YX LENGTH 153,5mm

- 01 N° 23600/152FMH (LIFAN)
- 01 N° E13K030 (YX)
- 01 N° A00K030 (88/ 125 SEMI-AUTO ET 125 POINT MORT) € 49

ARBRE BOÎTE SECONDAIRE COMPLET Ø 17 CÔTÉ PSB LIFAN Ø 14 CÔTÉ ALLUMAGE/ YX Ø 15 CÔTÉ ALLUMAGE
COMPLETE SECONDARY BOX SHAFT Ø 17 PSB SIDE LIFAN Ø 14 IGNITION SIDE/ YX Ø 15 IGNITION SIDE

- 02 N° 23700/152FMH (LIFAN)
- 02 N° E13K040 (YX)
- 01 N° A00K040 (88/ 125 SEMI-AUTO ET 125 POINT MORT) € 49

PIGNON INTERMÉDIAIRE EMBRAYAGE
INTERMEDIATE CLUTCH SPROCKET

- 03 N° 208-12-23N (YX : ÉPAISSEUR/ THICKNESS 14mm) € 12

JEU DE FOURCHETTES DE BOÎTE RENFORCÉE
REINFORCED GEARBOX FORK

- 04 N° FBR € 35

EMBRAYAGE CLUTCH



**EMBRAYAGE COMPLET DÉMARRAGE AU POINT MORT
START 2012-13**
COMPLETE CLUTCH NEUTRAL START
START 2012-13

N° EC € 65



EMBRAYAGE COMPLET 88/125 SEMI-AUTO
COMPLETE CLUTCH 88/125 SEMI-AUTO

N° 21100L € 79



EMBRAYAGE COMPLET POUR DÉMARRAGE EN PRISE
COMPLETE CLUTCH FOR KICKSTARTER ENGINE

N° 22100/152FMH € 82
N° 100103297 (Zongshen fiddy racer 110/125) € 79
N° 22000-JZ28-0000 (Zongshen 155) € 82



COURONNE D'EMBRAYAGE 88/125 SEMI-AUTO
CLUTCH SPROCKET 88/125 SEMI-AUTO

N° 22610L - 69 TEETH (START SE 88/125) € 20
N° A00K016 - 67 TEETH (LITE 88-125/ START 125) € 20



DISQUE D'EMBRAYAGE YX
YX CLUTCH PLATE

01 N° 22330/152FMH (GARNI/ FRICTION) € 6
02 N° 22341/152FMH (LISSE/ SMOOTH) € 6



DEMI CARTER EMBRAYAGE 88/ 125
HALF CLUTCH COVER 88/ 125

N° RCSC-BK € 25





JOINTS DE CARTER D'EMBRAYAGE
ENGINE CLUTCH COVER GASKET

01 N° E041B002 (START/ PILOT 125) € 9
02 N° 11319/152FMH (125 - 140 - 150CRF) € 7



JOINT SPY SÉLECTEUR
OIL SEAL SHAFT

01 N° 24190/152FMH € 7

JOINT SPY KICK
KICKSTARTER OIL SEAL

02 N° F001C015 (KLX: 16X28X7)
02 N° F05C085 (CRF: 16X24X5) € 6
02 N° 27190/152FMH (Ø 13mm)

JOINT SPY PSB
OIL SEAL FOR COUNTERSHAFT SPROCKET

03 N° 23790/152FMI (Ø 20 - 20/30/4.5) € 6
03 N° 23790/152FMH (Ø 17 - 17/29/5)

JOINT SPY TIGE COMMANDE EMBRAYAGE
CLUTCH CONTROL OIL SEAL

04 N° 22840/152FMH € 5

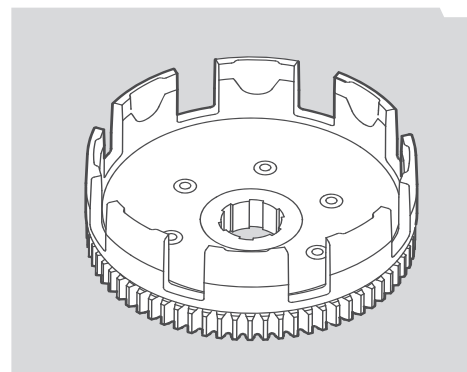

CLOCHE D'EMBRAYAGE
CLUTCH BELL

N° 22110/152FMH € 49

PIGNON DE KICK
KICKSTARTER SPROCKET YX

02 N° 27151/152FMH (LIFAN) € 15
02 N° 208K025 (YX)

PIGNON CLOCHE EMBRAYAGE
CLUTCH BELL SPROCKET

03 N° 27231/152FMH (LIFAN) € 15
03 N° 208-12-25 (YX)

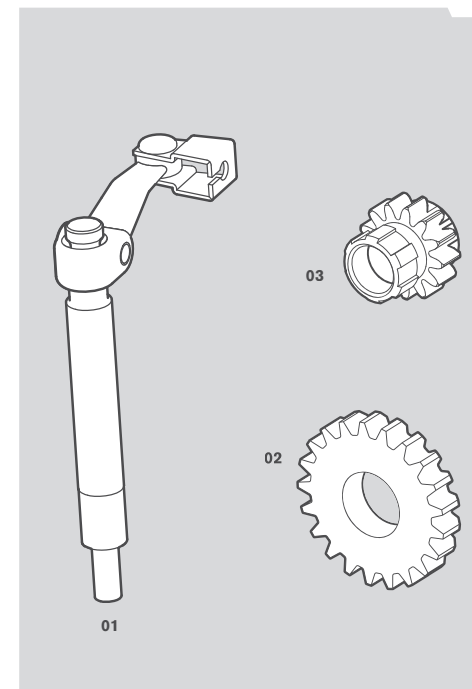

TIGE COMMANDE EMBRAYAGE
PUSH ROD

01 N° 22810/152FMH € 15



ARBRE À CAME RACING POUR MOTEUR 140/150 YX
(PILOT/BIGY 150)
RACING CAMSHAFT FOR YX 140/150 ENGINE
(PILOT/BIGY 150)

N° Z40 € 69



CARBURATEURS CARBURETORS

NIBBI



CARBURATEUR NIBBI

NIBBI CARBURETOR

01 N° YC50-20-31 POUR MOTEUR 50cc	€ 59
02 PE18FL POUR MOTEUR 88cc	€ 75
03 N° PE19FL POUR MOTEUR 125/150cc N° PE24SP (SM125/SM150)	€ 75
04 N° PE28SP POUR MOTEUR 190cc	€ 119
05 N° NIBBI34	€ 169

GICLEUR NIBBI CARBURATEUR PE GICLEUR PRINCIPAL / MAIN JET 88/90/92/95/98/100/102/105/108/110/112/115/118/120/122/125/128/130/132/135

06 N° LK-PE+TAILLE	€ 7
--------------------	-----

GICLEUR NIBBI CARBURATEUR PWK GICLEUR PRINCIPAL / MAIN JET 98/100/102/105/108/110/112/115/118/120/122/125/128/130/132/135/138/140/142/145/148

07 N° LK-PWK+TAILLE	€ 7
---------------------	-----

GICLEUR NIBBI CARBURATEUR PZ GICLEUR PRINCIPAL / MAIN JET 70/72/78/80/82/85/90/95/100

08 N° LK-PZ+TAILLE	€ 7
--------------------	-----

GICLEUR NIBBI CARBURATEUR PE/PWK GICLEUR RALENTI / SLOW JET 32/35/38/42/45/48

09 N° LK-FLK+TAILLE	€ 7
---------------------	-----

GICLEUR NIBBI CARBURATEUR PZ GICLEUR RALENTI / SLOW JET 32/35/38

10 N° LK-FLKZ+TAILLE	€ 7
----------------------	-----

NIBBI



KIT CARBURATEUR NIBBI 24

KIT CARBURETOR NIBBI 24

N° NIBBI24

€ 119

KEIHIN



CARBURATEUR KEIHIN® PE28mm

PE28mm KEIHIN® CARBURETOR

N° 85707

€ 239

MIKUNI



VIS DE CUVE MIKUNI®

MIKUNI® TANK SCREW

01 N° 16007L

€ 7

VIS RICHESSE + RESSORT MIKUNI®

MIKUNI® NEEDLE VALVE + SPRING

02 N° 16005L

€ 7

VIS RALENTI + RESSORT MIKUNI®

MIKUNI® IDLE SCREW + SPRING

03 N° 16006L

€ 7

GICLEUR RALENTI MIKUNI® 10/ 15/ 17,5/ 20/ 22,5/ 25

MIKUNI® SLOW JET

04 N° GICLEUR+SIZE

€ 7

GICLEUR PRINCIPAL MIKUNI® 85/ 90/ 92,5/ 95/ 97,5/ 100/ 102,5/ 105/ 107,5/ 110/ 115/ 120

MIKUNI® MAIN JET

05 N° GICLEUR+SIZE

€ 7

POINTEAU CARBURATEUR

CARBURETOR FLOAT NEEDLE

06 N° FLON-50A (YCF50A)

07 N° FLON-CARBU22 (MIKUNI® 22)

08 N° 16008L (MIKUNI® 26)

€ 12

AIGUILLE CARBURATEUR MIKUNI®

MIKUNI® CARBURETOR NEEDLE

09 N° 16004L

€ 15

JOINT CUVE CARBURATEUR

CARBURETOR FLOAT BOWL GASKET

10 N° 16010L (MIKUNI® 26)

11 N° SEAL-CARBU22 (MIKUNI® 22)

12 N° SEAL-PE28 (KEIHIN® PE28)

13 N° SEAL-50A (YCF 50A)

€ 5

€ 5

€ 7

€ 5



PIPE ADMISSION DAYTONA®
DAYTONA® INLET PIPE

- 01 N° 86404 (ANIMA) € 25
- N° 84387 (DT) € 30

PIPE ADMISSION SANS BOÎTE À AIR
INLET PIPE WITHOUT AIRBOX

- 02 N° 17311 € 16

PIPE ADMISSION POUR BOÎTE À AIR
INLET PIPE FOR AIRBOX

- 03 N° 17311-2 (POUR/ FOR FACTORY SPII) € 19
- 03 N° 17311-4 (POUR/ FOR PILOT 125) € 19
- 03 N° 17311-5 (POUR/ FOR PILOT 150) € 19
- 03 N° 17311-6 (POUR/ FOR PE28) € 19
- 03 N° 17311-3 (POUR/ FOR FACTORY SPIII) € 19

JOINT PAPIER PIPE ADMISSION
INLET PIPE PAPER GASKET

- 04 N° 17332/152FMH01 (ENTRE LA PIPE D'ADMISSION ET LE CARBURATEUR/ BETWEEN INLET PIPE AND CARBURETOR) € 2,50
- 04 N° 17332 (ENTRE LA CULASSE ET LA PIPE D'ADMISSION/ BETWEEN CYLINDER HEAD AND INLET PIPE) € 2,50

CALE PLASTIQUE PIPE ADMISSION
INLET PIPE PLASTIC HOLDER

- 05 N° 17331/152FMH € 6



FOR 50 ONLY



STARTER AU GUIDON POUR YCF50A
CHOKE LEVER FOR YCF50A

- 01 N° YC50-0142-01 € 19



MANCHON SOUPLE
FLEXIBLE SLEEVE

- 01 N° 17315 (VM 24) € 29
- 02 N° 46758 (POUR/ FOR DAYTONA®) € 35



FILTRES À AIR AIR FILTERS



SURFILTRE À AIR (VENDU SANS FILTRE À AIR)
AIR FILTER PROTECTION (AIR FILTER NOT INCLUDED)

N° K130K (POUR FILTRE ORIGINE YCF/ FOR YCF ORIGINAL AIR FILTER)
N° K386K (POUR/ FOR TWIN AIR)

€ 19



CAGE DE FILTRE À AIR
AIR FILTER CAGE

01 N° YC110-08-012
02 N° YC110-08-013

€ 10
€ 10

MANCHON DE BOÎTE À AIR YCF
YCF AIRBOX SLEEVE

03 N° YC110-08-0171 (Ø 49 POUR/ FOR KEHIN® PE28)
03 N° YC110-08-017 (Ø 40)
03 N° YC110-08-0173 (PILOT 125 2015-2020)
03 N° YC110-08-0174 (PILOT 150 2016-2020/ SM150 2016-2020)
03 N° YC110-0823-02 (BIGY 125 2021-23)
03 N° YC110-0823-03 (SP3 2021-22 / BIGY 150 - 190 2021-23)
03 N° YC110-0823-04 (PILOT 125 2021-23)
03 N° YC110-0823-07 (PILOT 150 2021-23)

€ 10



01 02 03

FILTRE À AIR MOUSSE
FOAM AIR FILTER

01 N° TA-158430 (POUR/FOR AIR BOX PILOT/ FACTORY/ BIGY)
02 N° TA-158432 (Ø 40mm POUR/ FOR MIKUNI® 26mm)
03 N° TA-158431 (Ø 50mm POUR/ FOR KEIHIN® 28mm)

€ 22
€ 27
€ 27



03 02

! PIPE ADMISSION ADÉQUATE, VOIR PAGE 126
SUITABLE INLET PIPE, CHECK PAGE 126

BOÎTE À AIR
AIRBOX

01 N° YC110-0801-07 (POUR/ FOR PILOT 125 & 150, 2015-23)
02 N° YC110-08-02 (POUR/ FOR FACTORY 2012-23)
03 N° YC110-0801-09 (POUR/ FOR LITE/ START)

€ 49



FILTRE À AIR MOUSSE
FOAM AIR FILTER

01 N° YC110-0802-03 (POUR/ FOR CARBU 22 mm)
(POUR FOR LITE/ START 88/ GP107) € 22
02 N° YC110-0802-10 (POUR/ FOR CARBU 26 MIKUNI/
NIBBI PE19FL/ PE24SP)(POUR FOR LITE/ START 125/
SM 125/150) € 22
03 N° YC110-0802-05 (POUR/ FOR CARBU KEIHIN/
NIBBI PE 28 mm) € 24



FILTRE À AIR EN MOUSSE POUR BOÎTE À AIR
FOAM AIR FILTER FOR AIR BOX

N° YC110-0817-03-BL
(PILOT 2016-22/ FACTORY 2012-23/ BIGY) € 17

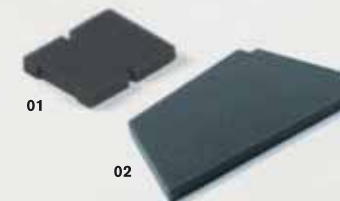

01 02

FILTRE À AIR EN MOUSSE POUR BOÎTE À AIR
FOAM AIR FILTER FOR AIR BOX

01 N° YC50-0802 (POUR/ FOR YCF 50) € 7
02 N° YC110-0817-02 (POUR/ FOR LITE/ START) € 13

ÉCHAPPEMENTS EXHAUSTS



**SPECIAL PARTS
YCF RACING**

LAINES DE ROCHE POUR SILENCIEUX
MUFFLER PACKING FOR NOISE REDUCTION

01 N° LR1 € 12

BRIDE DE POT POUR SILENCIEUX
MUFFLER SPARK ARRESTOR

02 N° YC110-13-30 € 30

JOINT DE POT
EXHAUST SEAL

03 N° 18291/152FMH € 2

EMBOUT DE POT 88/RS/RSP/SM 2011-2022
EXHAUST END FOR 88/RS/RSP/SM 2011-2022

04 N° YC110-13-32 € 19

RESSORT DE POT AVEC CAOUTCHOUC
EXHAUST SPRING WITH RUBBER

05 N° YC110-13-21 € 5

EMBOUT SILENCIEUX POUR LAVAGE MOTO
WASH MUFFLER PLUG

06 N° EEP-BL € 5

BRIDE DE POT
SPARK ARRESTOR

07 N° BP30BLACK (Ø 30) € 19

EMBOUT DE POT CRD®
CRD® EXHAUST END

08 N° YC110-13-31 € 19



ATTACHE SILENCIEUX OVALE (88, RS, RSP, SM 2011-22)
OVAL MUFFLER CLAMP (88, RS, RSP, SM 2011-22)

N° YC110-13-06

€ 15



ÉCHAPPEMENTS RACING RACING EXHAUSTS



FACTORY
SPECIAL PARTS
YCF RACING

LIGNE ÉCHAPPEMENT COMPLÈTE RACING SIMPLE
COMPLETE RACING EXHAUST SINGLE

N° YC110-136-07-BK (POUR/ FOR PILOT/ SM150)
N° YC110-139-07-BK (POUR/ FOR FACTORY)
N° YC110-140-01-BK (POUR/ FOR BIGY)

€ 299



FACTORY
SPECIAL PARTS
YCF RACING

ATTACHE SILENCIEUX FACTORY
FACTORY MUFFLER CLAMP

N° YC110-1307-03

€ 19



RESSORT DE POT FACTORY
FACTORY EXHAUST SPRING WITH RUBBER

N° YC110-13-22

€ 5



FACTORY
SPECIAL PARTS
YCF RACING

SILENCIEUX RACING FACTORY
FACTORY RACING EXHAUST

N° YC110-13014-03BK

€ 149



SILENCIEUX ANTI-BRUIT
SPARK ARRESTOR

N° YC110-13014-02-GY

€ 99



FACTORY
SPECIAL PARTS
YCF RACING

LIGNE ÉCHAPPEMENT COMPLÈTE RACING DOUBLE
COMPLETE RACING EXHAUST TWIN

N° YC110-136-08-BK (POUR/ FOR PILOT/ SM150)
N° YC110-139-08-BK (POUR/ FOR FACTORY)
N° YC110-140-02-BK (POUR/ FOR BIGY)

€ 399



COLLECTEUR RACING
RACING MID PIPE

- N° YC110-1302-22 (PILOT) € 89
- N° YC110-1302-13 (SP3) € 89
- N° YC110-1308-01 (BIGY) € 89



Y DU COLLECTEUR RACING DOUBLE
DOUBLE RACING MID PIPE Y

- N° YC110-1302-23 (PILOT)
- N° YC110-1302-14 (SP)
- N° YC110-1308-03 (BIGY) € 79



PARTIE INTERMÉDIAIRE COLLECTEUR RACING
RACING MID PIPE INTERMEDIATE PART

- N° YC110-1302-24 (PILOT)
- N° YC110-1302-15 (SP)
- N° YC110-1308-02 (BIGY) € 49



ÉCHAPPEMENT YCF ANTI-BRUIT (GAMME FACTORY)
SPARK ARRESTOR YCF EXHAUST (FACTORY RANGE)

- N° YC110-139-03 (POUR/ FOR FACTORY SP2 & SP3)
- N° YC110-139-09 (POUR/ FOR BIGY) € 249



ÉCHAPPEMENT GROS DIAMÈTRE AVEC BRIDE DE POT AMOVIBLE
LARGE DIAMETER EXHAUST SUPPLIED WITH REMOVABLE SPARK ARRESTOR

- N° YC110-136-GY (POUR/ FOR START) € 99
- N° YC110-136-03-GY (POUR/ FOR PILOT/ SM 150) € 99
- N° YC110-139-10 (POUR/ FOR BIGY) € 169



COLLECTEUR ÉCHAPPEMENT FACTORY
FACTORY EXHAUST MID PIPE

- N° YC110-13028-01 (SP3) € 119
- N° YC110-13028-03 (BIGY 190) € 119
- N° YC110-13028-05 (PILOT) € 119
- N° YC110-13028-02 (SP3 DOUBLE) € 149
- N° YC110-13028-04 (BIGY DOUBLE) € 149
- N° YC110-13028-06 (PILOT DOUBLE) € 149



COLLECTEUR ÉCHAPPEMENT BIGY
BIGY EXHAUST MID PIPE

- N° YC110-1302-20 (125/150 BIGY MX) € 59
- N° YC110-1302-26 (190 BIGY ZE) € 59
- N° YC110-1302-28 (150 BIGY FACTORY) € 69

FILTRES & RADIATEURS FILTERS & COOLERS



KIT COMPLET RADIATEUR HUILE
COMPLETE OIL COOLER KIT

N° YC110-2307 (DIAM 10/10 DAYTONA @/ YX150-5 (CRF))
N° YC110-2305 (DIAM 8/10 YX150-2 (KLX)/ ZONGSHEN 155-G/ ZONGSHEN 125-G) € 95



KIT RADIATEUR UNIVERSEL ADAPTABLE SUR TOUS LES MODÈLES
UNIVERSAL OIL COOLER KIT ADAPTABLE TO ALL MODELS

N° YC110-2306 (VENDU AVEC 6 DURITES/ SOLD WITH 6 HOSES) € 249



PETITE JAUGE HUILE NOIRE/ BLEUE/ ROUGE/ VERTE/ ORANGE
LITTLE OIL DIPSTICK BLACK/ BLUE/ RED/ GREEN/ ORANGE

01 N° JH01-COLOR (SM150/ FACTORY/ BIGY FACTORY 150/190) € 19



FILTRE À HUILE
OIL FILTER

01 N° 216E010 € 19
01 N° 14210-1038-0000 (110/125/155 ZONGSHEN FIDDY RACER)
LITE110R/ SM125/155/ PILOT 125 2022/ BIGY 125 2022 € 19



ÉPURATEUR D'HUILE ALLÉGÉ
FLYWHEEL

02 N° 208G082 € 25



DURITE HUILE RADIATEUR
OIL COOLER HOSE

N° YC110-23-01 (2007)
N° YC110-23-013 (L=400MM)
N° YC110-23-014 (L=285MM/ Ø=8/8)
N° YC110-23-015 (L=260MM/ Ø=8/8)
N° YC110-23-016 (L=125MM/ Ø=10/8)
N° YC110-23-017 (L=290MM/ Ø=10/10)
N° YC110-23-0003 (L=110MM/ Ø=10/8)
N° YC110-23-02 (2007)
N° YC110-23-022 (L=490MM)
N° YC110-23-023 (L=395MM/ Ø=10/8)
N° YC110-23-024 (L=495MM/ Ø=10/8)
N° YC110-23-025 (L=360MM/ Ø=10/10)

€ 19

SPECIAL PARTS
YCF RACING



JAUGE HUILE NOIRE/ BLEUE/ ROUGE/ VERTE/ ORANGE
OIL DIPSTICK BLACK/ BLUE/ RED/ GREEN/ ORANGE

N° JH-COLOR (LITE/ START/ PILOT/ BIGY 125/150 MX) € 19

SPECIAL PARTS
YCF RACING



BOUCHON VIDANGE AIMANTÉ
NOIR/ BLEU/ ROUGE/ VERT/ ORANGE
MAGNETIC DRAIN PLUG
BLACK/ BLUE/ RED/ GREEN/ ORANGE

01 N° BVE1-COLOR € 12

HUBLOT À HUILE
OIL LEVEL SIGHT GLASS

02 N° D00C027 € 10

ALLUMAGE IGNITION



FAISCEAU ÉLECTRIQUE WIRING HARNESS

- 01 N° YC110-1501 (NON ÉTANCHANCHE/ NO WATERPROOF) € 15
- N° YC110-1501-12 START SE 88/125 (CONNECTEUR ÉTANCHE/ WATERPROOF CONNECTION) € 15
- N° YC110-1501-08 BIGY (DÉMARREUR ÉLECTRIQUE/ ÉLECTRIC START/ CONNECTEUR ÉTANCHE/ WATER-PROOF CONNECTION) € 19
- N° YC110-1501-09 BIGY (SANS DÉMARREUR/ WITHOUT ÉLECTRIC START CONNECTEUR ÉTANCHE/ WATERPROOF CONNECTION) € 19
- N° YC110-1501-11 (LITE/START/PILOT/SP) (SANS DÉMARREUR/ WITHOUT ÉLECTRIC START CONNECTEUR ÉTANCHE/ WATERPROOF CONNECTION) € 19

BOÎTIER CDI CDI BOX

- 02 N° YC110-1503 € 15

BOBINE HAUTE TENSION HIGH TENSION IGNITION COIL

- 03 N° YC110-1504 € 15

BATTERIE BATTERY

- 04 N° YC110-1507-02 (88 & 125SE) € 39
- 04 N° YC110-1507-04 (190ZE) € 45



CDI RACING CDI RACING

- N° YC110-1503-01 € 29

FOR 50A ONLY



ALLUMAGE YCF 50A YCF 50A IGNITION

- 01 N° YC50-1502 (RÉGULATEUR DE TENSION/ TENSION REGULATOR) € 15
- 02 N° YC50-1510 (RELAIS DÉMARREUR/ STARTER RELAY) € 15
- 03 N° YC50-1507-01 (BATTERIE POUR 50A/ BATTERY FOR 50A) € 35
- 04 N° YC50-1514 (CHARGEUR BATTERIE/ BATTERY CHARGER) € 35
- 05 N° YC110-1564 (CONTACTEUR À CLÉ AVEC LE SUPPORT/ WATERPROOF KEY SWITCH) € 15
- 06 N° 82200-D083-000151 (DÉMARREUR 88/ 125SE) € 59
- 07 N° YC50-20-66 (DÉMARREUR 50A) € 59
- 08 N° YC110-1563-01(SHUNT ÉTANCHE/ SHUNT WATERPROOF) € 3



ALLUMAGE MAGNETO

- 01 N° RRG (ALLÉGÉ/ LIGHTWEIGHT) € 99
- 02 N° 31 100/152FMH € 69
- 03 N° 31 210/152FMH (PRISE ÉTANCHE) € 69
- 04 N° 82120-G011-30534 (START SE) € 35





COUPE CIRCUIT
REMOTE SWITCH

- | | |
|--|------|
| 01 N° YC110-0105-01 (SWITCH ON/OFF) | |
| 02 N° YC110-0105 (SWITCH) | € 15 |
| 03 N° YC110-0105-21 (SWITCH-WATERPROOF) | € 20 |
| 04 N° YC110-0105-05 (SWITCH + LEASH) | € 29 |
| 08 N° YC110-0139-03 (BOUTON DÉMARREUR/ START SWITCH) | € 15 |

COMPTEUR D'HEURE & SUPPORT
HOUR METER & SUPPORTING PLATE

- | | |
|--|------|
| 05 N° STANDCOMPT-H (SUPPORT/ SUPPORTING PLATE) | € 10 |
| 06 N° COMPT-H (COMPTEUR D'HEURE/ HOUR METER) | € 29 |
| 07 N° COMPT01-H (COMPTEUR D'HEURE VIBRATION/ HOUR METER VIBRATION) | € 39 |



FOR 50 ONLY

COUPE CIRCUIT À DISTANCE
VENDU AVEC 2 TÉLÉCOMMANDES

DISTANCE ENGINE CUT OFF
SOLD WITH 2 REMOTES CONTROL

N° YC50-1518 € 79



BOUGIE & ANTI PARASITE
SPARK PLUG & SPARK PLUG CAP

- | | |
|---|------|
| 01 N° 221D021 (4 SOUPAPES YX/ YX 4 STROKE) | € 45 |
| 02 N° 34210/152FMH (CR7HS) | € 12 |
| 03 N° 34210/D8EA (D8EA 125 R START 2012-13) | € 9 |
| 04 N° YC110-1505 (CAP/ ANTI PARASITE) | € 7 |



DAYTONA® ANIMA®
RACING PARTS/PIECES RACING



CHAÎNE DE DISTRIBUTION RENFORCÉE D.I.D
D.I.D REINFORCED TIMING CHAIN

N° 87577 € 69



PISTON FORGÉ POUR ANIMA®
FORGED PISTON FOR ANIMA®

N° 87173 (150cc) € 99
N° 88599 (190cc) € 109



KIT ARBRE À CAME RACING
RACING CAMSHAFT KIT

N° 87583 € 299



KIT 212cc
212cc KIT

N° 88011 € 379



KIT ALLUMAGE F-SM RÉGLABLE
MULTI CURVES ROTOR KIT

N° 87235 € 269



COUVRE FILTRE HUILE ANIMA® NOIR/ BLEU/ ROUGE/ VERT/ ORANGE

ANIMA® OIL FILTER COVER BLACK/ BLUE/ RED/ GREEN/ ORANGE

N° OFCDAYT-COLOR € 25



COUVRE CULASSE ANIMA® RACING
ANIMA® RACING CYLINDER HEAD COVER

N° 87994 € 49



PIPE ADMISSION ANIMA® 15°
INTAKE MANIFOLD ANIMA® 15°

N° YC110-2012-01 € 49



CHAÎNE DE DÉMARREUR RENFORCÉE DID
STARTER CHAIN DID

N° 89522 € 49

DAYTONA®

DAYTONA® ANIMA® 2,0 150/ 190cc (4 VALVES) GENUINE PARTS/ PIÈCES D'ORIGINES

DAYTONA

SEQ #	PART #	DESCRIPTION	QTY	(€) UNIT PRICE
1	86461	BOLT, CROSS RECESSED COUNTERSUNK M6x15	2	1,00
2	86464	BOLT, HEXAGON FLANGE M6x25	2	1,00
3	86472	BOLT, HEXAGON FLNAGE M6x32	1	1,00
4	87349	BOX, CDI, DESIGNATION FDX	1	119,00
4	89373	BOX, CDI FSM-SYS 2024	1	99,00
5	86426	COIL, IGNITION	1	19,00
6	86373	COVER, MAGNET	1	39,00
7	89678	FLYWHEEL MAGNET COMP FDX	1	79,00
7	88127	FLYWHEEL MAGNET COMP FSM-SYS 2024	1	65,00
8	86452	NUT, MAGNET M12	1	2,00
9	86479	O-RING, Ø6,5xØ1,8	2	2,00
10	86916	STATOR ASSY, DESIGNATION FDX	1	89,00
10	88129	STATOR ASSEMBLY FSM	1	89,00
10	80744	STATOR ASSY, SYS 2024	1	65,00
11	86428	WIRE HERNESS	1	39,00

DAYTONA

SEQ #	PART #	DESCRIPTION	QTY	(€) UNIT PRICE
1	84678	BOLT, CROSS RECESSED COUNTERSUNK M6x30	1	2,00
2	84677	BOLT, CROSS RECESSED COUNTERSUNK M6x35	2	2,00
3	84676	GASKET, PUMP OIL	1	2,00
4	83747	PIN, DOWEL Ø8xØ6,3x12	2	2,00
5	86382	PUMP, OIL ASSY	1	49,00

DAYTONA

SEQ #	PART #	DESCRIPTION	QTY	(€) UNIT PRICE
1	86446	BOLT, BANJO M10x22,5	2	3,00
2	86362	BOLT, HEXAGON FLANGE M6x105	1	2,00
3	86486	BOLT, HEXAGON FLANGE M6x15	2	3,00
4	86469	BOLT, HEXAGON FLANGE M6x22	2	2,00
5	86485	BOLT, HEXAGON FLANGE M6x28	2	2,00
6	86471	BOLT, HEXAGON FLANGE M6x30	2	2,00
7	86473	BOLT, HEXAGON FLANGE M6x50	2	2,00
8	86474	BOLT, HEXAGON FLANGE M6x55	1	2,00
9	83759	BOLT, HEXAGON FLANGE M6x60	1	2,00
10	86361	BOLT, HEXAGON FLANGE M6x90	1	2,00
11	86376	COVER, CLUTCH	1	120,00
12	86374	COVER, OIL FILTER	1	15,00
13	86377	COVER, SMALL CLUTCH	1	59,00
14	83489	FILTER, OIL	1	19,00
15	86437	GASKET, COVER CLUTCH	1	15,00
16	86476	GASKET, M10	4	2,00
17	86412	HOLDER, CABLE CLUTCH	1	9,00
18	86414	LEVER, CLUTCH COMP	1	35,00
19	86432	O-RING, Ø38,6x2,6	1	3,00
20	86435	O-RING, COVER SMALL CLUTCH	1	5,00
21	86441	OIL SEAL, Ø16xØ26x7	1	5,00
22	86442	OIL SEAL, Ø17xØ10x5	1	4,00
23	86406	OIL THROUGH COMP	2	25,00
24	83747	PIN, DOWEL Ø8xØ6,3x12	4	2,00
25	86386	RULER	1	5,00
26	86413	SPRING, LEVER CLUTCH	1	2,00
27	86375	SPRING, OIL FILTER	1	2,00
28	86475	WINDOW, OIL LEVEL	1	15,00

DAYTONA®

ALLUMAGE GENERATOR

ANIMA® 2,0 150/ 190CC

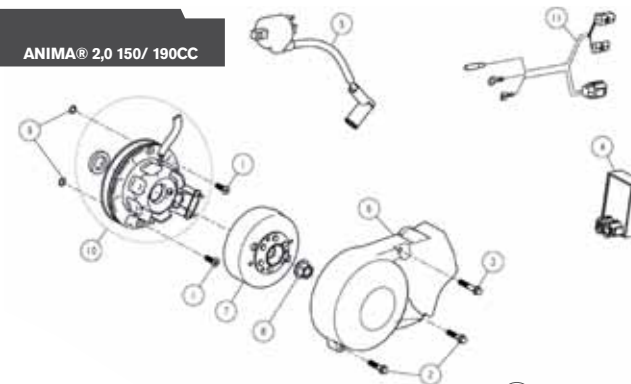

DAYTONA®

POMPE À HUILE OIL PUMP

ANIMA® 2,0 150/ 190CC

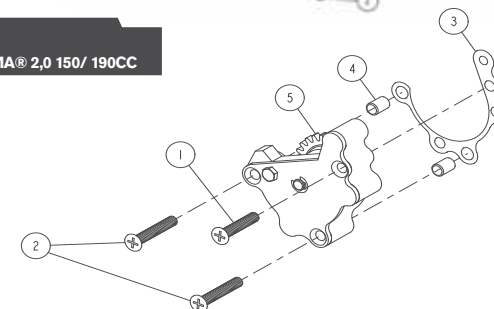

DAYTONA®

CARTER EMBRAYAGE COVER CLUTCH

ANIMA® 2,0 150/ 190CC

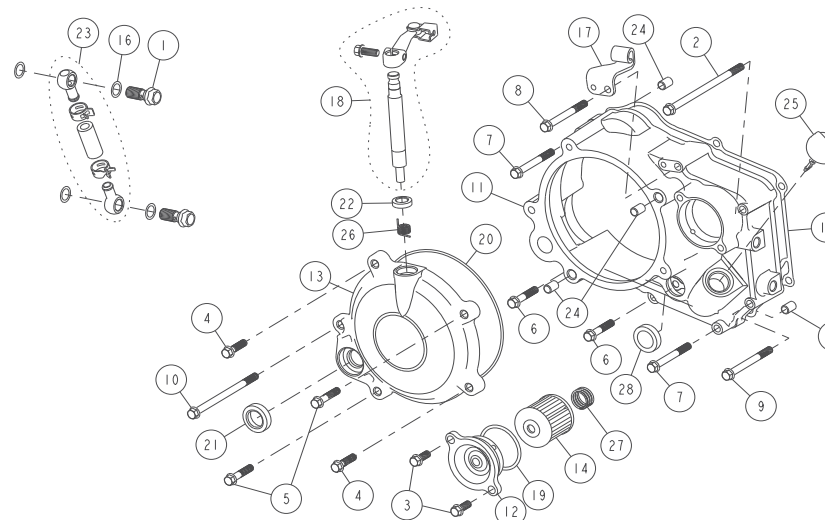

DAYTONA

SEQ #	PART #	DESCRIPTION	QTY	(€) UNIT PRICE
1	86453	CLIP, PIN PISTON	2	2,00
2	86381	CRANK SHAFT ASSY ANIMA 150	1	199,00
3	86620	CRANK SHAFT ASSY ANIMA 190	1	219,00
3	87760	CRANK SHAFT ASSY ANIMA 160	1	199,00
3	89144	CRANK SHAFT ASSY ANIMA 190-5 SPEEDS	1	229,00
3	80601	CRANK SHAFT ASSY ANIMA 190 SYS 2024	1	229,00
4	86383	GEAR, OIL PUMP DRIVE	1	15,00
5	86415	GEAR, PRIMARY DRIVE	1	29,00
6	83768	NUT, SMALL M14	1	5,00
7	86443	OIL SEAL, Ø12xØ20x5t	1	6,00
8	86379	PIN, PISTON Ø14	1	5,00
8	89978	PIN PISTON L=39 SYS 2024	1	5,00
9	86378	PISTON DT150	1	59,00
10	86621	PISTON DT190	1	65,00
10	80316	PISTON 190 SYS 2024	1	69,00
11	86462	RETAINING RING, RTWN22	1	2,00
12	86380	RING SET, PISTON	1	30,00
12	89977	RING SET, PISTON 66MM-SYS 2024	1	30,00
13	86411	WASHER, SPRING	1	3,00

DAYTONA

PISTON & VILEBREQUIN
PISTON & CRANK SHAFT

ANIMA® 2,0 150/ 190CC

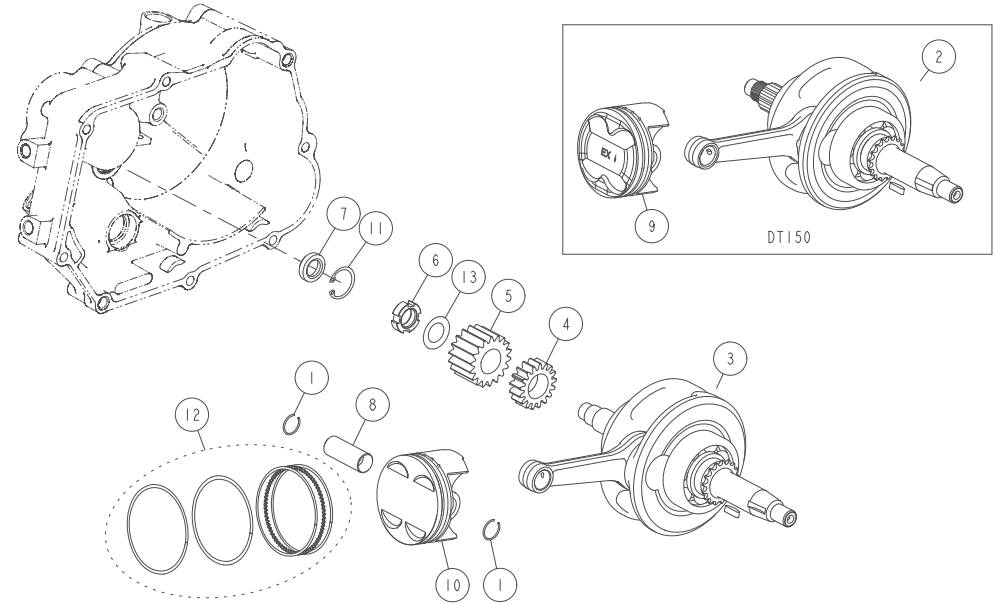

DAYTONA

SEQ #	PART #	DESCRIPTION	QTY	(€) UNIT PRICE
1	86474	BOLT, HEXAGON FLANGE M6x55	1	2,00
2	83761	BOLT, HEXAGON FLANGE M6x65	1	2,00
3	86360	BOLT, HEXAGON FLANGE M6x70	5	2,00
4	86459	BOLT, HEXAGON SOCKET M6x105	2	3,00
5	83755	BOLT, OIL DRAIN M12x15	1	3,00
6	86444	BOLT, STUD A	2	6,00
7	86445	BOLT, STUD B	2	6,00
8	86369	COVER, STRAINER OIL	1	5,00
9	86370	CRANK CASE, LH	1	129,00
9	89143	CRANK CASE, LH, 5 SPEEDS	1	149,00
10	86884	CRANK CASE, RH	1	119,00
10	88848	CRANK CASE, RH, 5 SPEEDS	1	119,00
11	86438	GASKET, CRANKCASE	1	9,00
12	86371	HOSE, BREATHER	1	12,00
13	86451	NUT FLANGE, M8	4	2,00
14	86433	O-RING, Ø30xØ3	1	2,00
15	83720	PIN, DOWELØ10xØ8,4x14	2	2,00
16	86385	SPRING, STRAINER	1	2,00
17	86387	STRAINER, OIL	1	5,00
18	86457	WASHER, GASKET M8	4	2,00
19	83754	WASHER, OIL DRAIN M12	1	5,00

DAYTONA

CARTER
CRANKCASE

ANIMA® 2,0 150/ 190CC

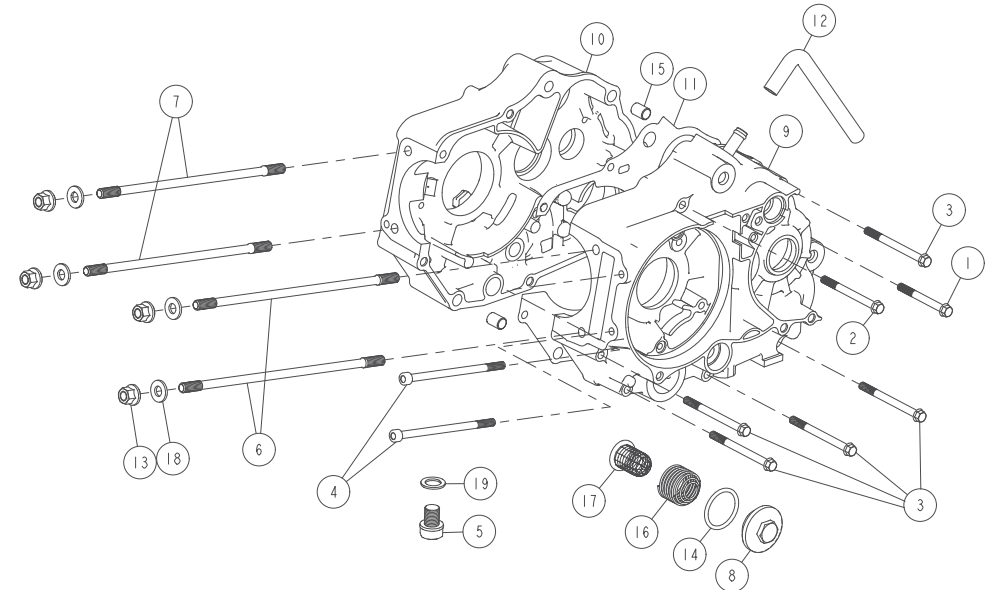

SEQ #	PART #	DESCRIPTION	QTY	(€) UNIT PRICE
1	86448	BOLT, HEXAGON FLANGE M10x16	1	3,00
2	85877	BOLT, HEXAGON FLANGE M6x12	1	1,00
3	86468	BOLT, HEXAGON FLANGE M6x18	6	1,00
4	86466	BOLT, HEXAGON FLANGE M6x25	1	1,00
5	86471	BOLT, HEXAGON FLANGE M6x30	1	2,00
6	83703	BOLT, STUD M6x32	2	2,00
7	86367	COVER, CYLINDER HEAD	1	45,00
8	86366	CYLINDER	1	249,00
8	87975	CYLINDER 190 SYS 2024	1	339,00
9	89458	GASKET,BASE CYLINDER 190 SYS 2024	1	19,00
9	86436	GASKET, BASE CYLINDER	1	15,00
10	86440	GASKET, HEAD CYLINDER	1	19,00
11	86476	GASKET, M10	1	2,00
12	86405	GASKET, MANIFOLD	1	2,00
13	86439	GASKET, TANSIONER CAM CHAIN	1	2,00
14	86368	HEAD, CYLINDER	1	249,00
15	86404	MANIFOLD, INTAKE	1	25,00
16	86479	O-RING	1	2,00
17	86434	O-RING, COVER HEAD	1	15,00
18	83720	PIN, DOWEL Ø10xØ8,4x14	4	2,00
19	83747	PIN, DOWEL Ø8xØ6,3x12	1	2,00
20	221D021	SPARK PLUG ER9EH	1	45,00
21	86396	TENSIONER, CAM CHAIN COMP	1	25,00
22	86456	WASHER, Ø6,3xØ12x1,5	1	2,00

CULASSE ANIMA®
HEAD CYLINDER

ANIMA® 2,0 150/ 190CC

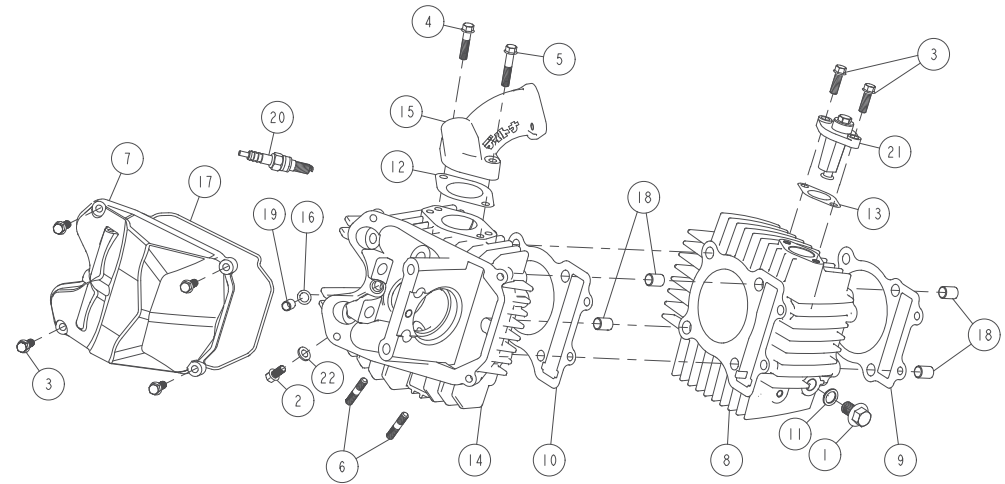

SEQ #	PART #	DESCRIPTION	QTY	(€) UNIT PRICE
1	86481	ARM, ROCKER ROLLER EXHAUST COMP	1	59,00
2	86393	ARM, ROCKER ROLLER INTAKE COMP	1	59,00
3	86460	BOLT, COUNTERSINK M6x15	1	1,00
4	86883	SCREW M6X16	2	2,00
5	86447	BOLT, TENSIONER	1	3,00
6	86878	CAMSHAFT 240Ø ROLLER DECOMP ASM	1	99,00
7	86391	CHAIN, CAMSHAFT DRIVE	1	35,00
8	86402	COTTER, VALVE	8	5,00
9	89681	SHAFT W/WEIGHT,DECOMP,V3	1	49,00
10	86395	GUDE , CHAIN CAMSHAFT	1	20,00
11	86389	PLATE, STOPPER CAM	1	5,00
12	86400	RETAINER, SPRING VALVE	4	5,00
13	86403	SEAL, VALVE STEM Ø4.5	4	6,00
14	86401	SEAT, SPRING VALVE	4	4,00
15	86392	SHAFT, ROCKER	2	5,00
16	87621	SPRING,RETURN DECOMP.	1	3,00
17	86624	SPRING, VALVE	4	16,00
18	86879	SPROCKET, CAMSHAFT DRIVEN	1	19,00
19	87620	PLATE,STOPPER DECOMP.	1	4,00
20	86394	TENSIONER, CAM CHAIN	1	20,00
21	86623	VALVE, EXHAUST Ø21	2	30,00
22	86397	VALVE, INTAKE Ø24.5	2	19,00

DISTRIBUTION
VALVE MECHANIS

ANIMA® 2,0 150/ 190CC

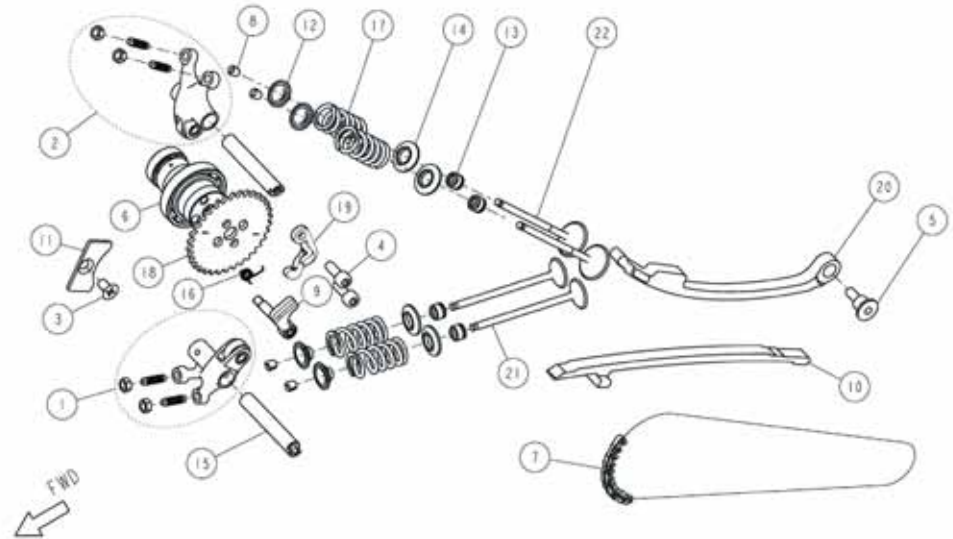

DAYTONA

SEQ #	PART #	DESCRIPTION	QTY	(€) UNIT PRICE
1	83786	BEARING, #6000	1	7,00
2	87619	CLUTCH COMP (FORGED GEAR)	1	199,00
3	86417	GEAR, STARTER DRIVEN 2 13T	1	25,00
4	83768	NUT, SMALL M14	1	5,00
5	83787	PIN, LIFTER CLUTCH	1	20,00
6	86410	WASHER, SPRING Ø24xØ14,2x1,2 1	1	1,00

DAYTONA

**EMBRAYAGE
CLUTCH**

ANIMA® 2,0 150/ 190CC

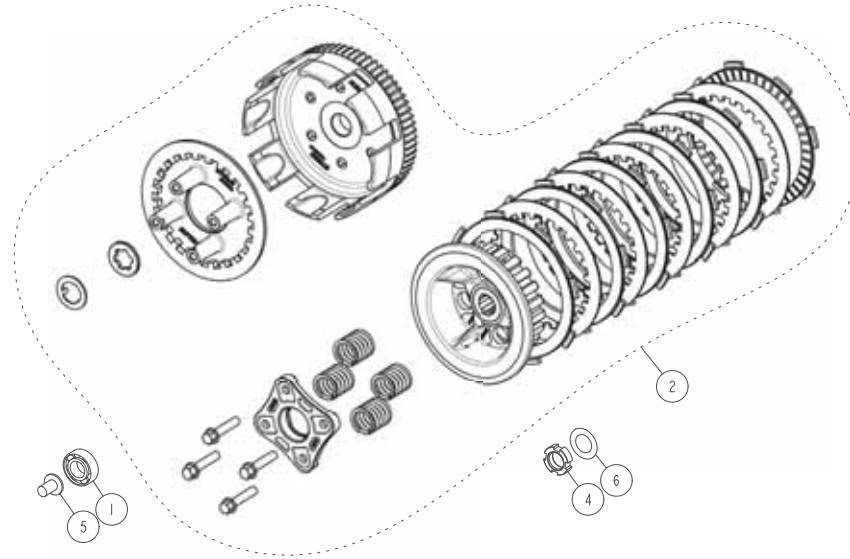

DAYTONA

SEQ #	PART #	DESCRIPTION	QTY	(€) UNIT PRICE
1	83788	BEARING #6001	1	12,00
2	83795	BEARING #6203	2	15,00
3	86454	BEARING NK152712	1	15,00
4	86464	BOLT, HEXAGON SOCKET M6x10	2	1,00
5	86418	GEAR IDLE, STARTER	1	20,00
6	86919	GEAR, COMP,4 SPEED	1	149,00
6	89682	GEAR, COMP 5 SPEED	1	149,00
7	83796	OIL SEAL, Ø29xØ17x5	1	3,00
8	86420	PLATE, FIXING SPROCKET DRIVE 1	1	2,00
9	86463	RETAINING RING Ø13,6	1	2,00
10	86419	SPROCKET, DRIVE 15T	1	15,00
11	86455	WASHER, Ø22xØ15x0,5	2	1,50

DAYTONA

**BOÎTE DE VITESSE
GEARBOX**

ANIMA® 2,0 150/ 190CC

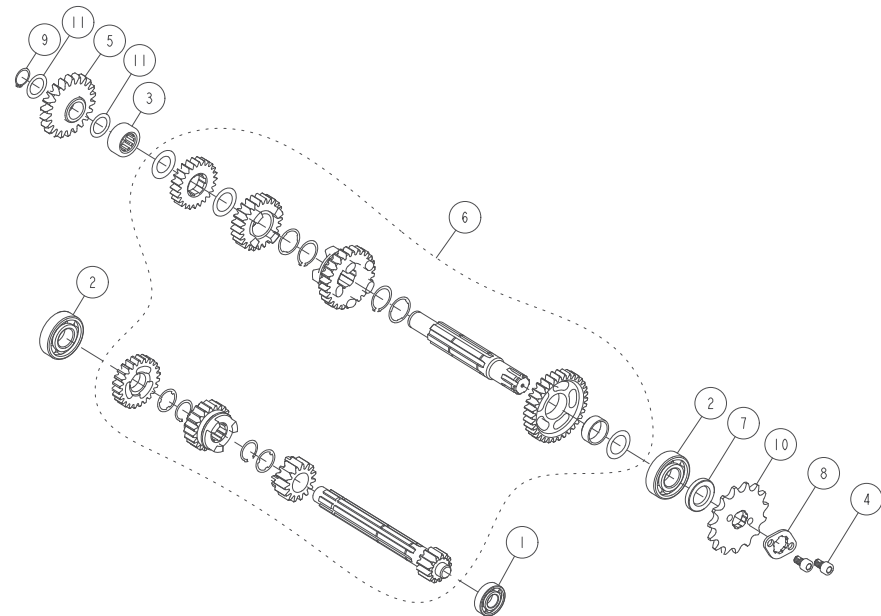



SEQ #	PART #	DESCRIPTION	QTY	(€) UNIT PRICE
1	86449	BOLT, HEXAGON SOCKET M6	1	2,00
2	85877	BOLT, HEXAGON SOCKET M6x15	1	1,00
3	83833	CONTACT, GEAR INDICATION	1	3,00
4	86421	DRUM, SHIFT N-1-2-3-4 COMP	1	55,00
4	88423	DRUM, SHIFT 5 SPEEDS	1	55,00
6	86422	LEVER, GEAR SHIFT COMP	1	20,00
6	88886	LEVER, GEAR SHIFT COMP 5 GEAR	1	20,00
7	86424	LOCATING PLATE UNIT	1	4,00
8	83837	OIL SEAL, Ø24xØ16x10	1	6,00
9	86480	PIN, LOCATING SHIFT LEVER	1	3,00
10	85876	PLATE, LOCATING SWITCH NEUTRAL	1	2,00
11	86423	SPRING, LOCATING PLATE	1	2,00



BOÎTE/ FOURCHETTES GEARBOX MECHANISM

ANIMA® 2,0 150/ 190CC

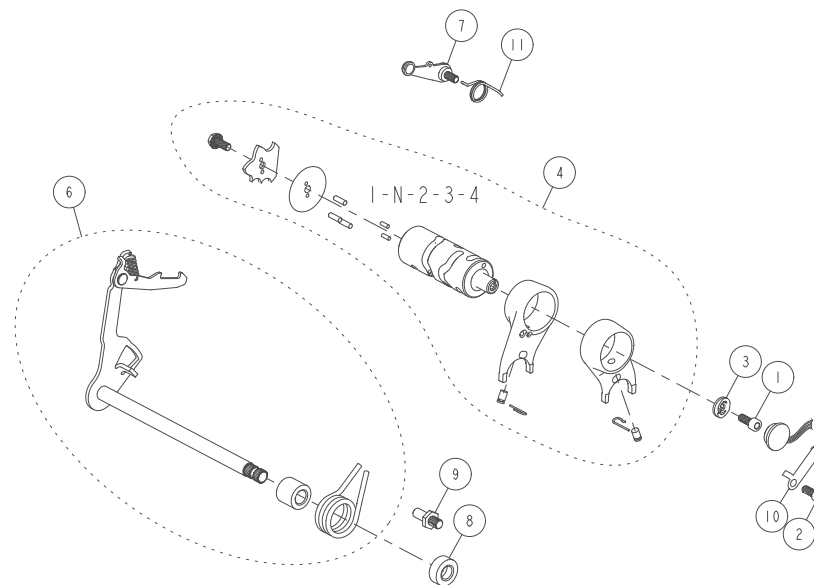

SEQ #	PART #	DESCRIPTION	QTY	(€) UNIT PRICE
1	86407	KICK STARTER ASM	1	89,00
1	88883	KICK ASSY 5 GEAR	1	69,00



KICK KICK STARTER

ANIMA® 2,0 150/ 190CC

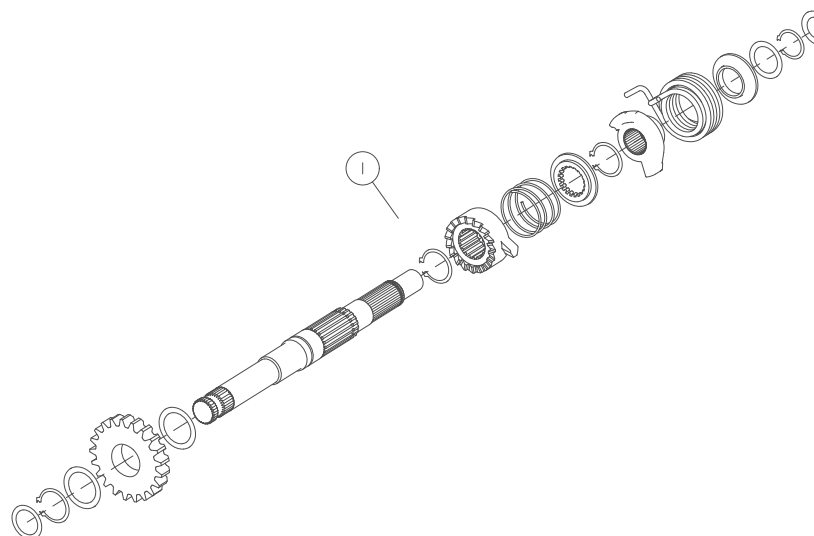

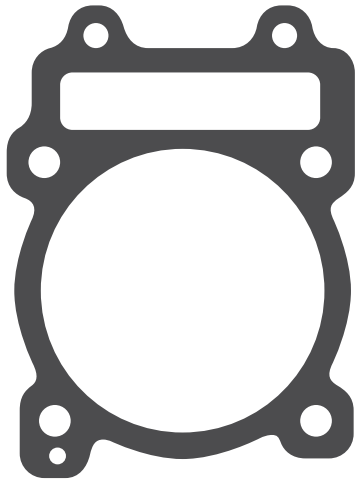

ART DIRECTION

ENCORE STUDIO

GRAPHIC DESIGN

F. ALAUX, T. JUMIN & Q. BRACHET

INDUSTRIAL DESIGN

FRANÇOIS ALAUX FOR YCF MOTORCYCLES

THANKS TO

#111

STEPHANE LE CORRE, CATHERINE HOSSARD & YCF CREW MEMBERS

JORDI TIXIER/ MATHIS ANNE/ JULES ASSELAIN/ MADY HUAN

TRACK

DOMAINE DE LA BUTTE RONDE



WELCOMETOENCORE.COM

PHOTOGRAPHY

ACTION & STUDIO: PASCAL HAUDIQUERT

PARTS: ANTOINE CADOT

YCF FOUNDERS

DIMITRI BERA & YANNICK COQUARD