

① **Front tire** →

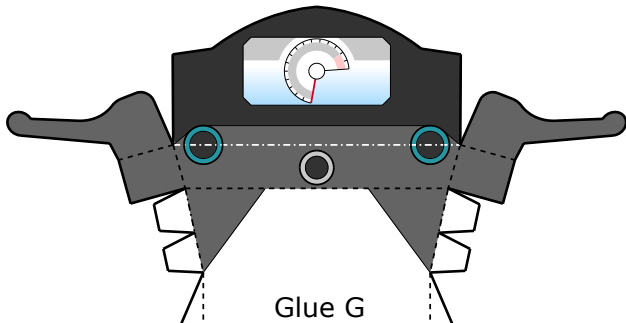

Glue G

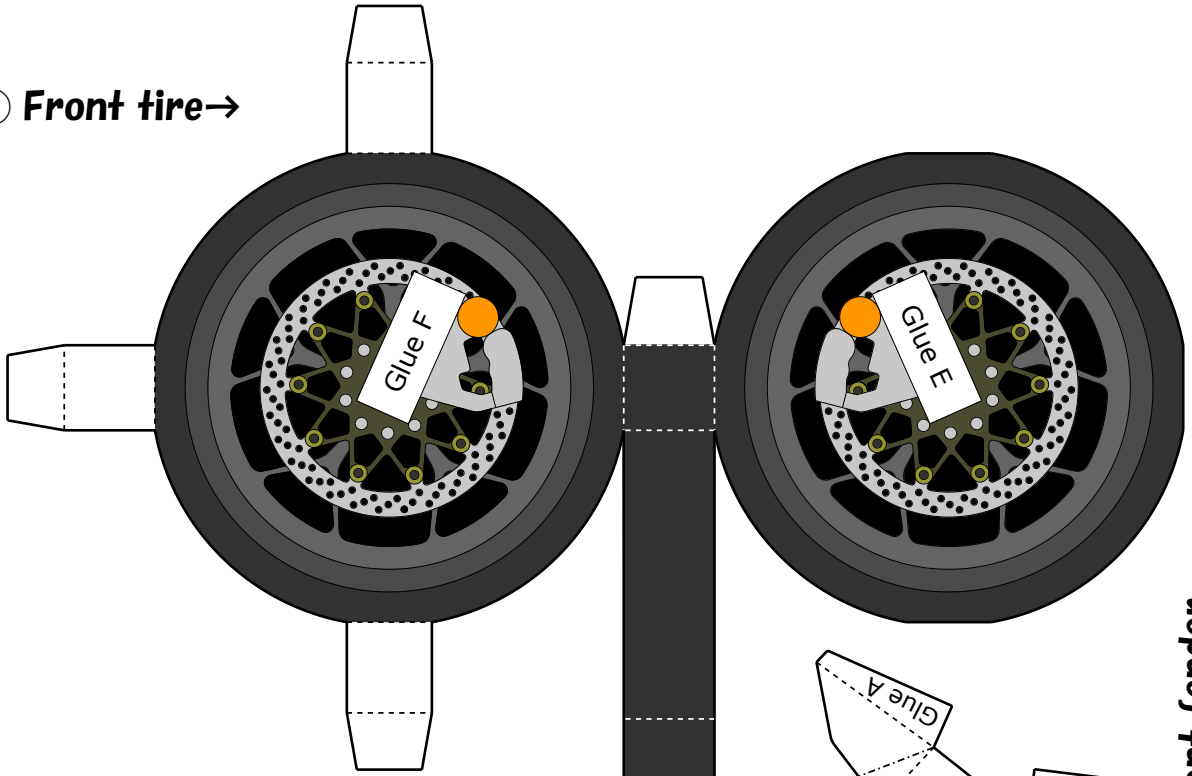
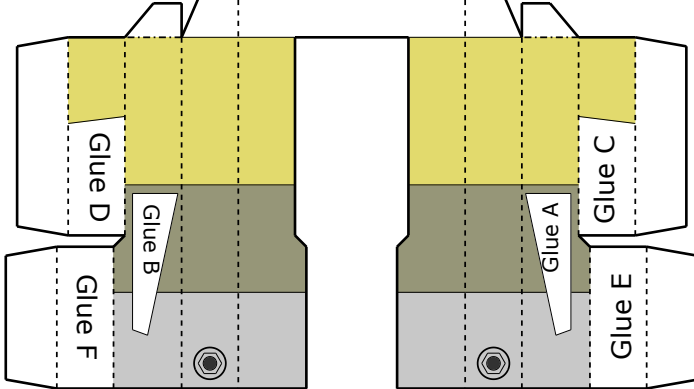

② **Front fork** ↑

----- Mountain fold  
- - - - - Valley fold

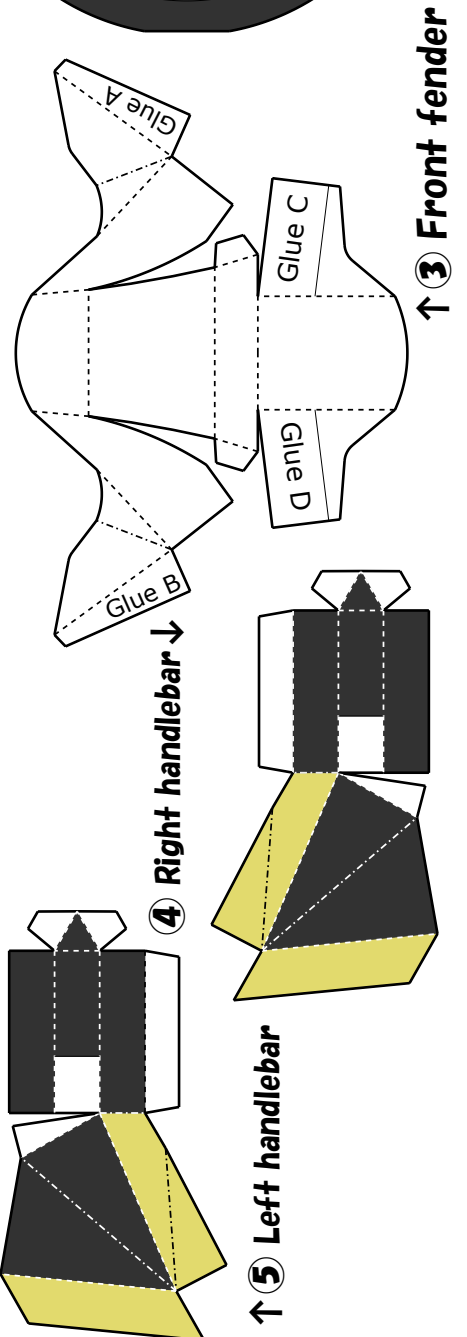

↑ ③ **Front fender**

↓ ④ **Right handlebar**

↑ ⑤ **Left handlebar**

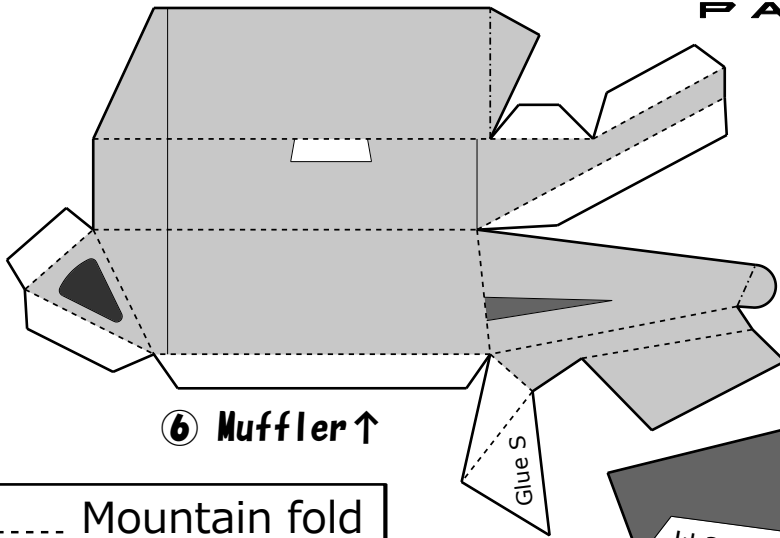

⑥ Muffler ↑

----- Mountain fold  
- - - - - Valley fold

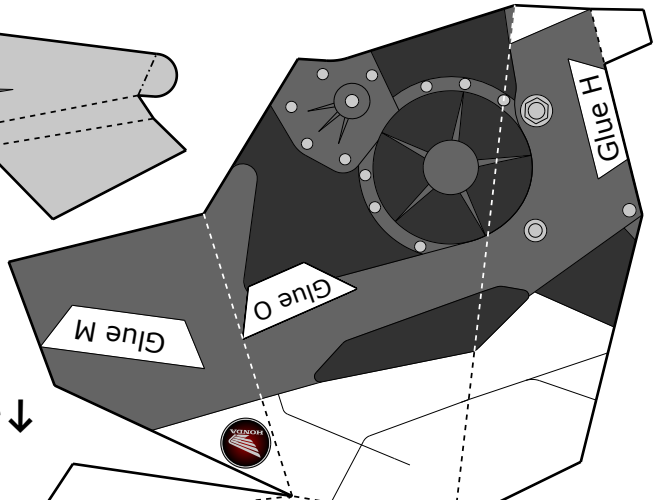

⑦ Chassis ↓

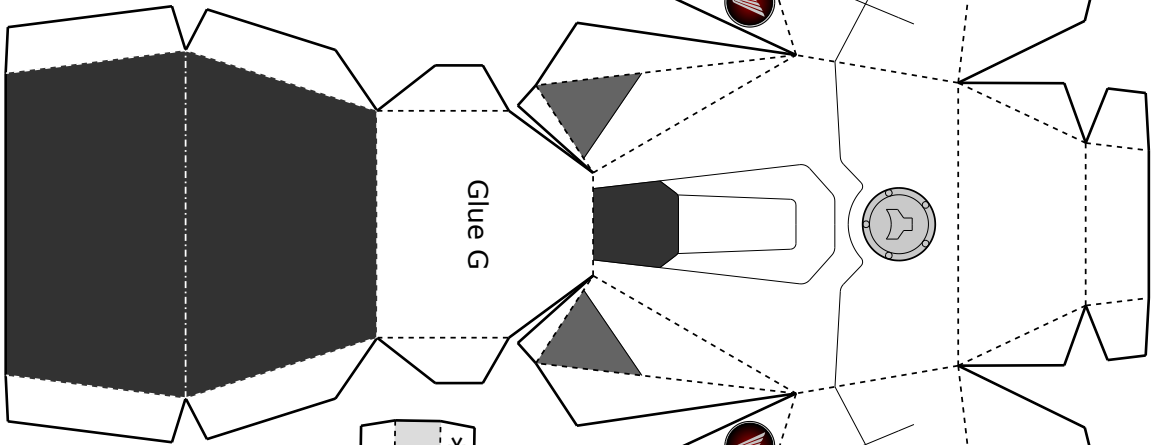

⑨ Left swingarm ↓

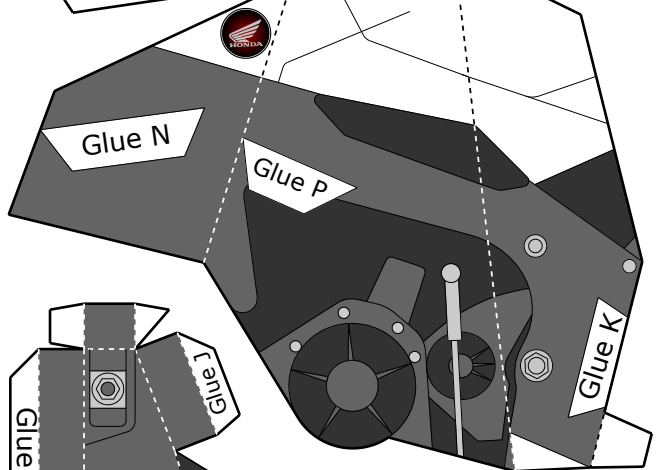

↓ ⑪ Left step

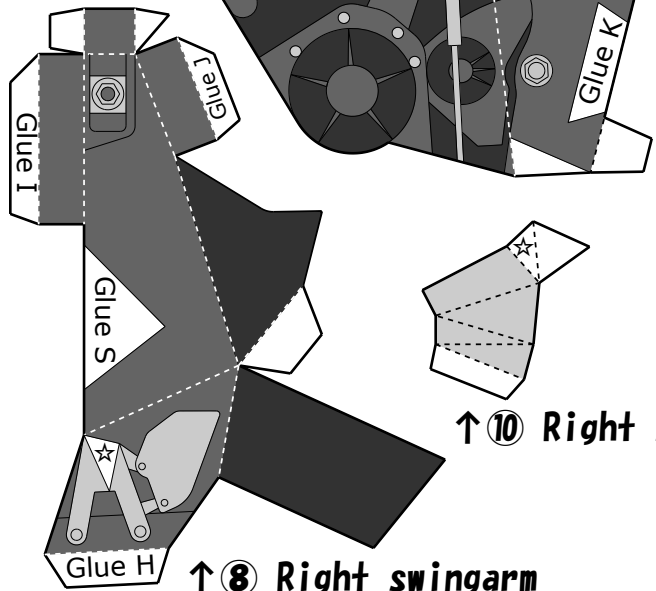
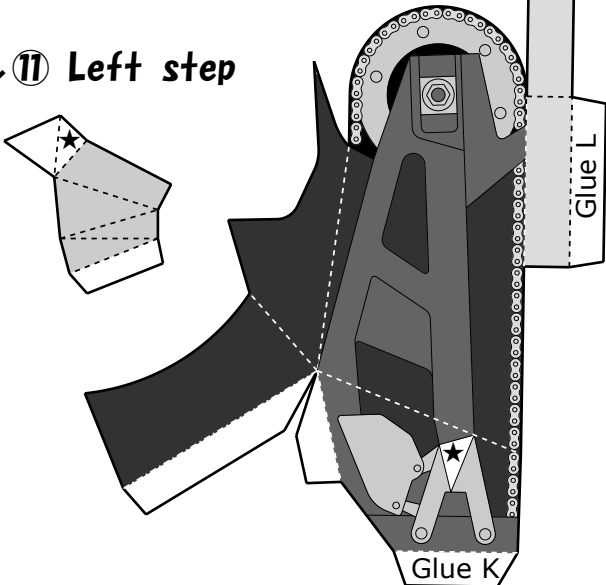

↑ ⑩ Right step

↑ ⑧ Right swingarm

Always follow road manners when riding.

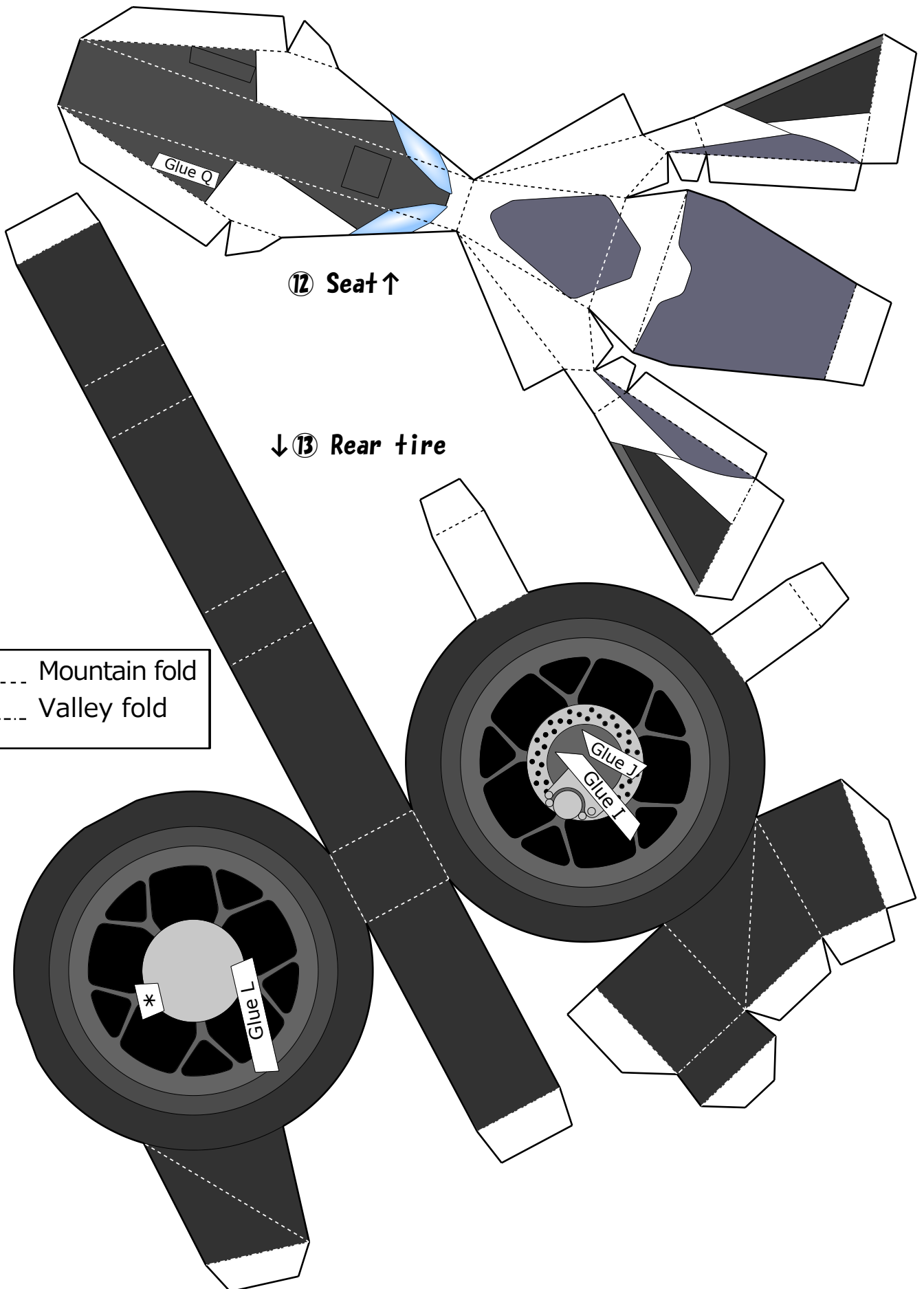

**If you're not confident with your riding skills, or you're a novice rider, join a school or attend seminars.**

⑭ Under cowl ↓

⑳ License plate →

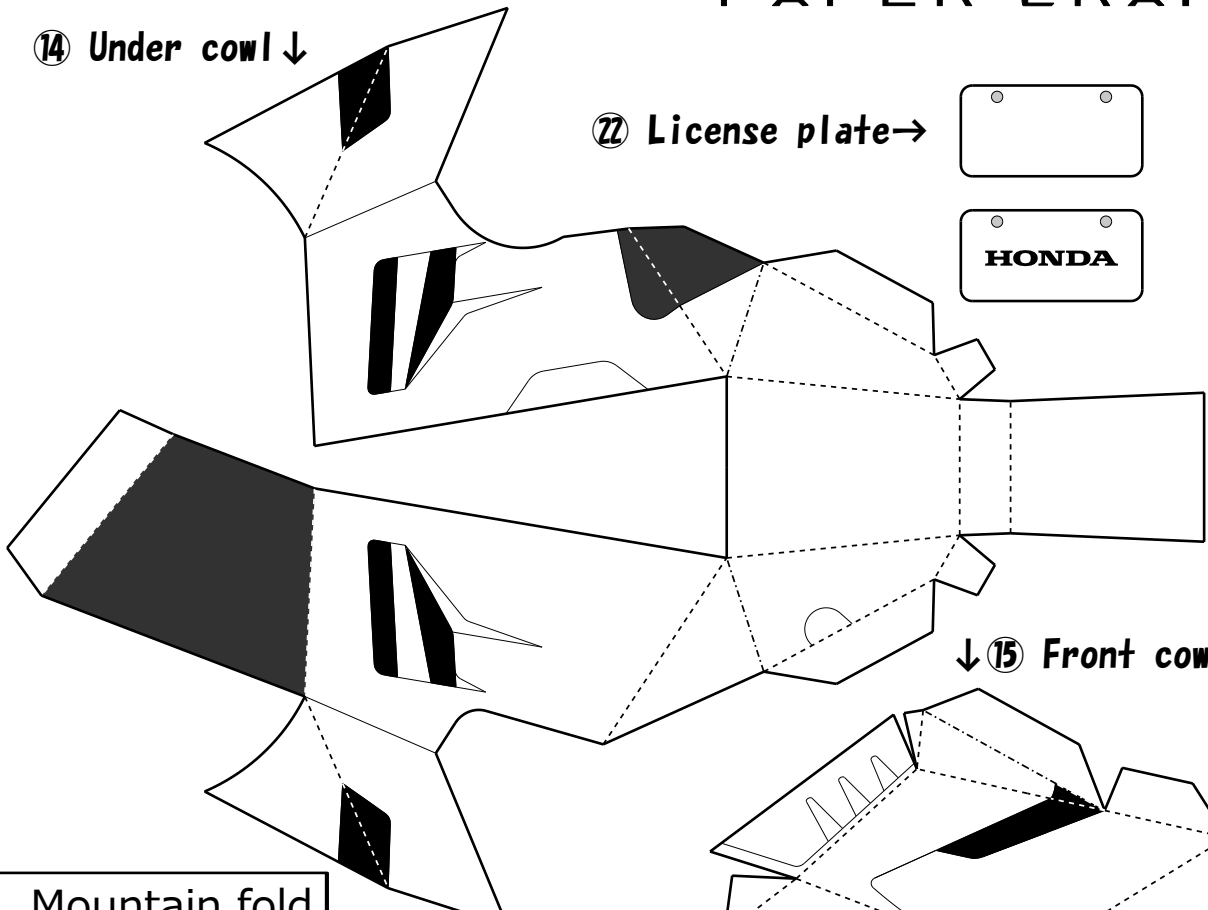
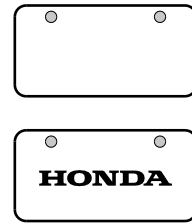

↓ ⑮ Front cowl

----- Mountain fold  
 ----- Valley fold

↓ ⑱ Muffler bracket

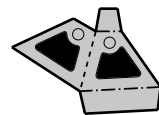

↓ ㉑ Rear fender

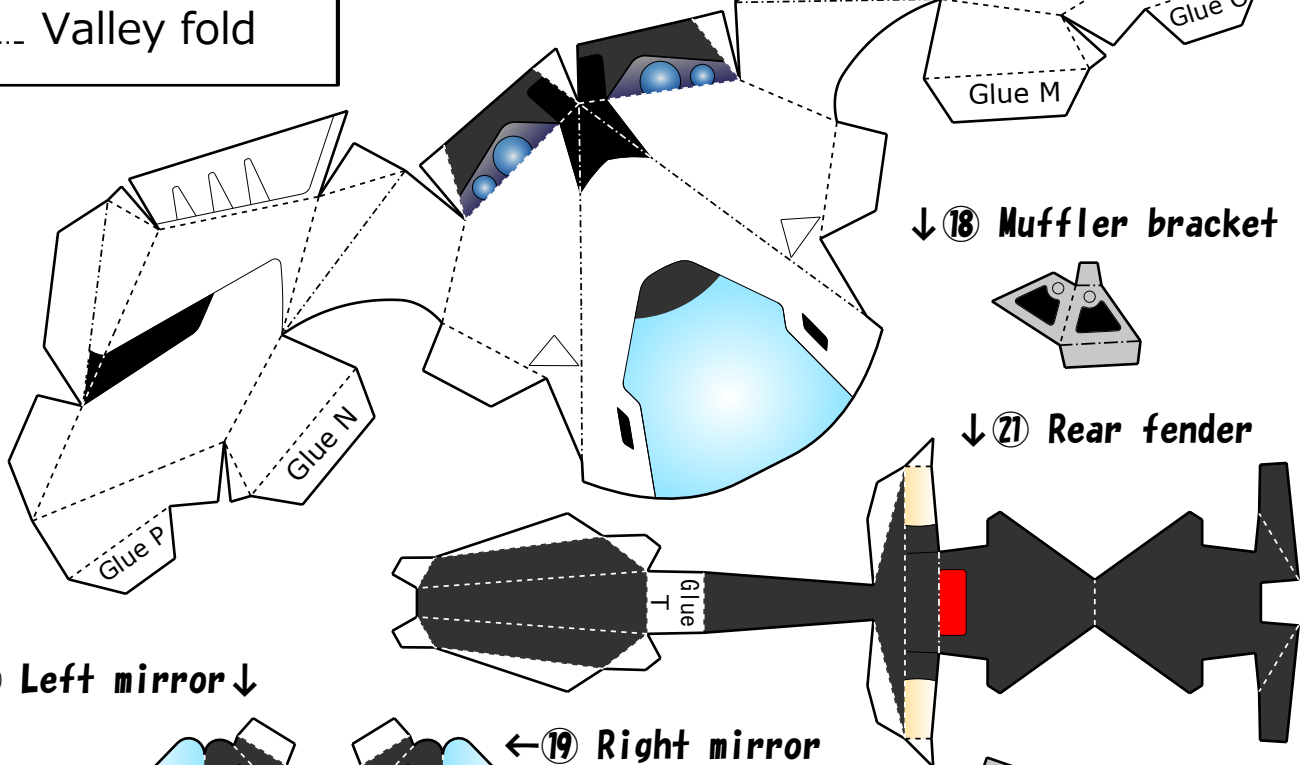

⑳ Left mirror ↓

← ⑲ Right mirror

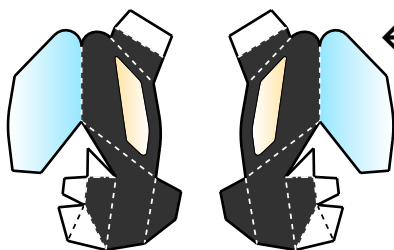

⑰ Left pillion step →

↑ ⑯ Right pillion step

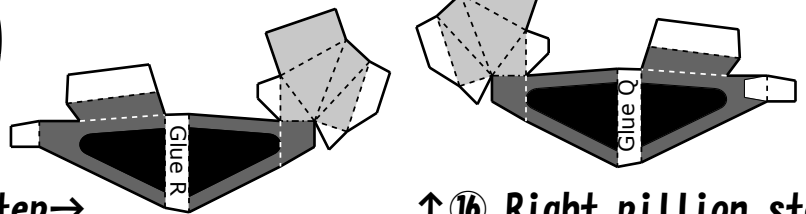

Always wear the right gear such as a helmet and chest protector when riding.



Assembly instructions

## Introduction

Thank you for downloading the paper craft CBR1000RR-R.

In 2018, Honda assembled from its associates a paper craft development team, so kids could know about motorcycles, and enjoy making things. The team made the paper craft CBR1000RR-R so that despite races being canceled due to the coronavirus, everyone can enjoy their time at home, and gain an interest in motor sports.

This paper craft model is designed for primary to secondary school students, and even grownups to enjoy.

Follow the instructions to build your own CBR1000RR-R!

## Before you begin

- Recommended printing paper.
  - Thickness of 0.20 to 22. Strong finish.
- What you need:
  - **Glue** (paper or wood glue recommended)
  - **Scissors** (or a utility knife for detailed cuts)
  - **Toothpick or cotton swab** (to spread glue or press down on small joins)
- What might help:
  - **Tweezers** (to assemble detailed parts)
  - **Ruler** (to make creases)
  - **Old ballpoint pen** (to make creases)
- Hints:
  - First crease your parts.
  - Spread glue thinly and evenly, making sure you stay within the instructed areas.
  - When joining parts, hold the glued joins together for around 10 seconds using your fingers or tweezers.
  - When using your fingers, don't press too hard.
- Folding:
  - 

## Step ①: Front tire

① Fold along lines.



② Apply glue.

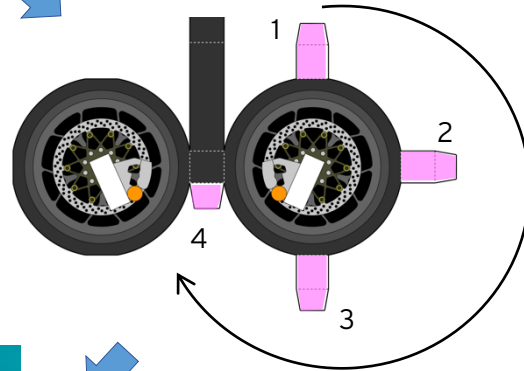

③ Join together.

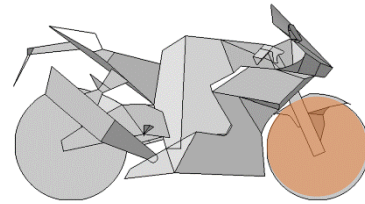

## Step ②: Front forks

① Fold along lines.

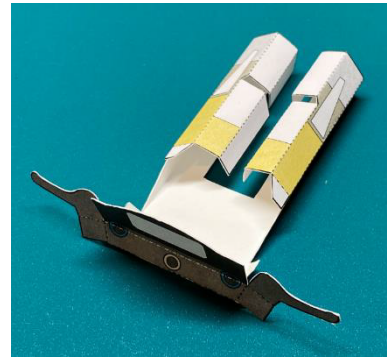

② Apply glue.

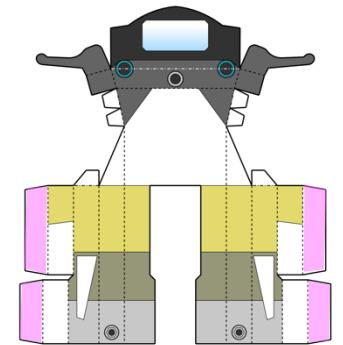

③ Join together.

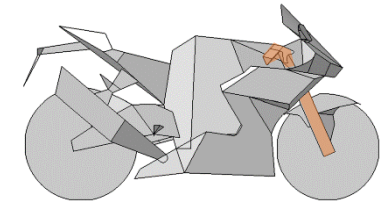
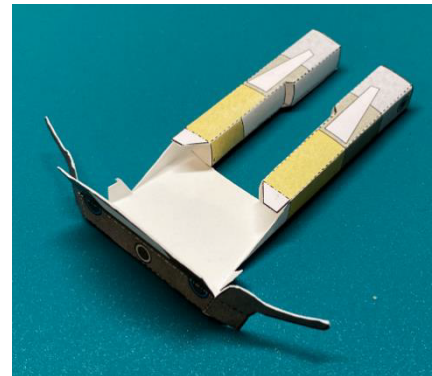

### Step ③: Front fender

① Fold along lines.

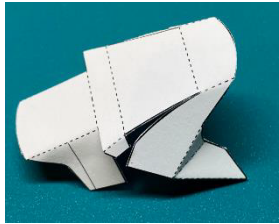

② Apply glue.

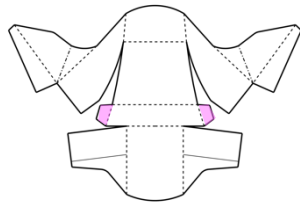

③ Join together.

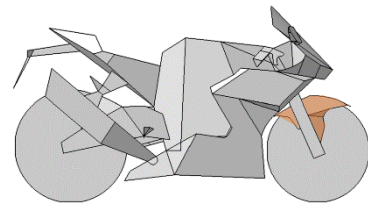

### Steps ④⑤: Right/left handle bars

① Fold along lines.



② Apply glue.

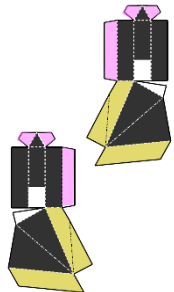

③ Join together.

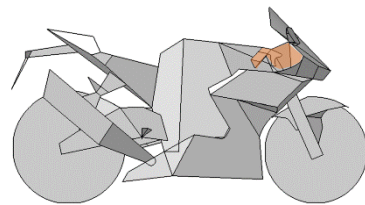
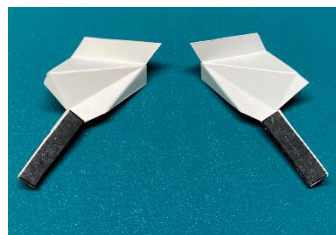

### Step ⑥: Muffler

① Fold along lines.

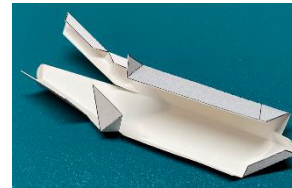

② Apply glue.

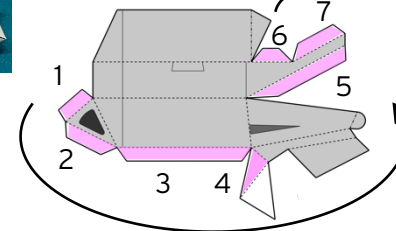

③ Join together.

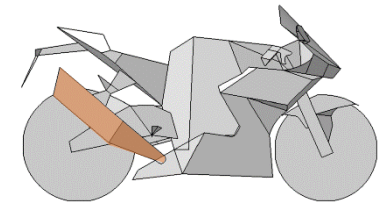
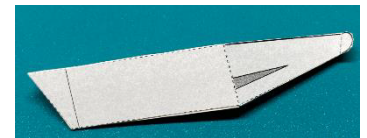

**Follow this order!**

### Step ⑦: Chassis

① Fold along lines.



② Apply glue.

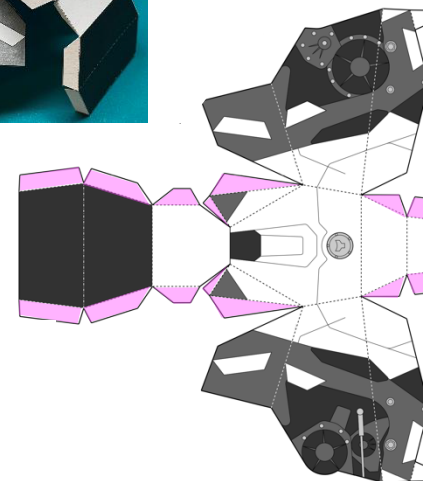

③ Join together.

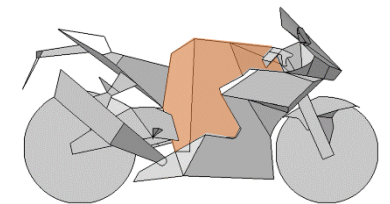



## Step ⑧: Right swingarm

① Fold along lines.

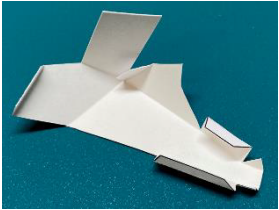

② Apply glue.

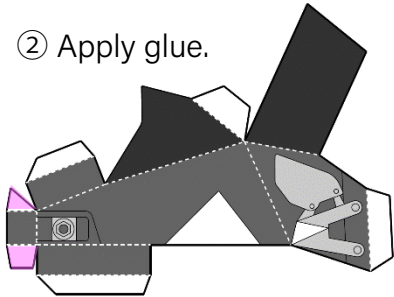

③ Join together.

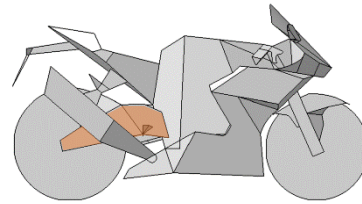
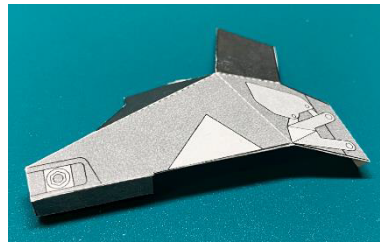

## Step ⑨: Left swingarm

① Fold along lines.



② Apply glue, and flip over.

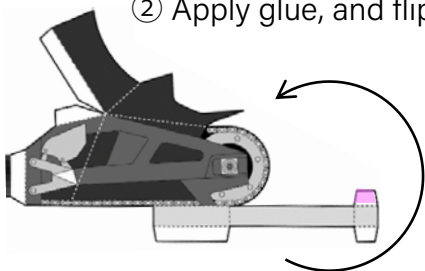

③ Join together.

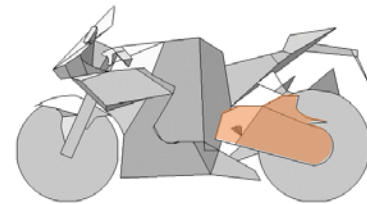

## Step ⑧+⑨: Joining the swingarms

① Fold along lines.

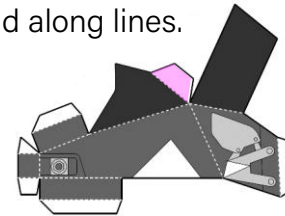

+

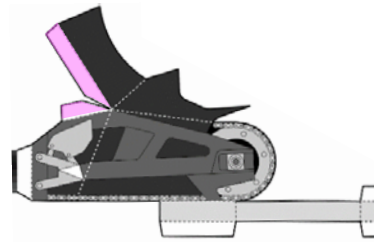

② Apply glue, and join the swingarms.

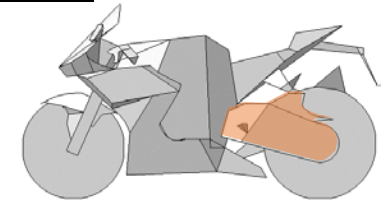
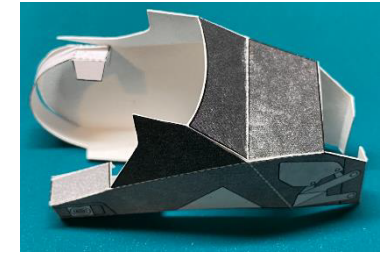

## Steps ⑩⑪: Right / left steps

① Fold along lines.



② Apply glue.

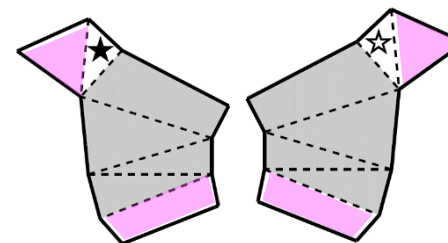

③ Join together.

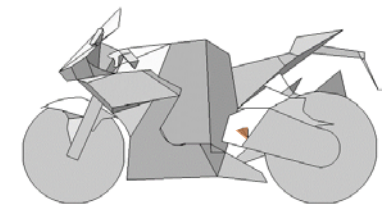

## Step 12: Seat

① Fold along lines.

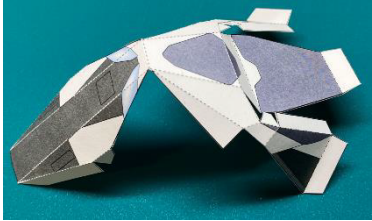

② Apply glue (pink first, green next).

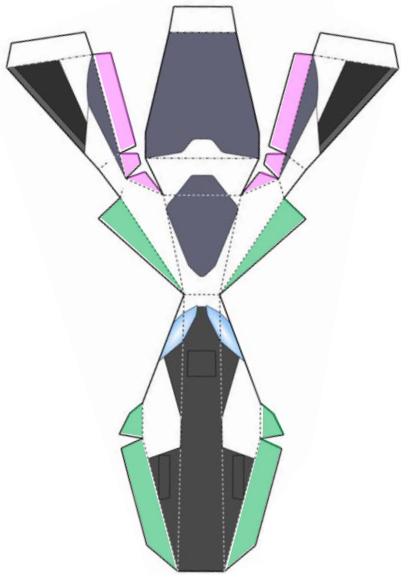

③ Join pink.

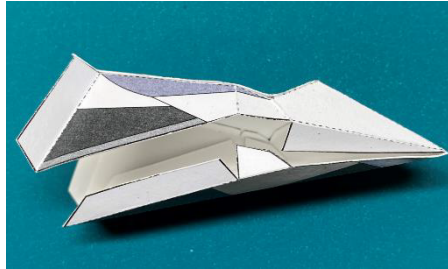

④ Join green.

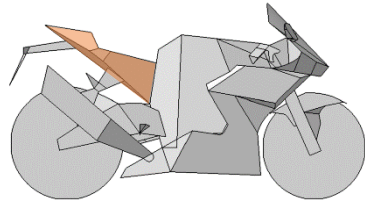
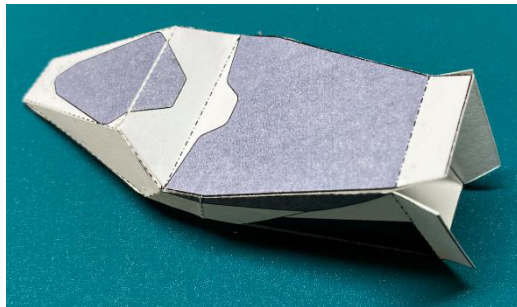

## Step 13: Rear tire

① Fold along lines.

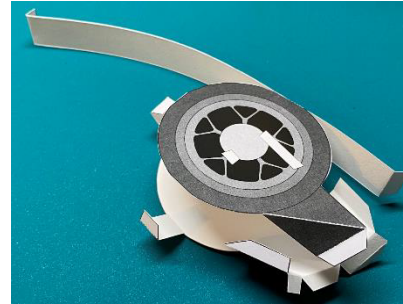

② Apply glue (pink first, green next).

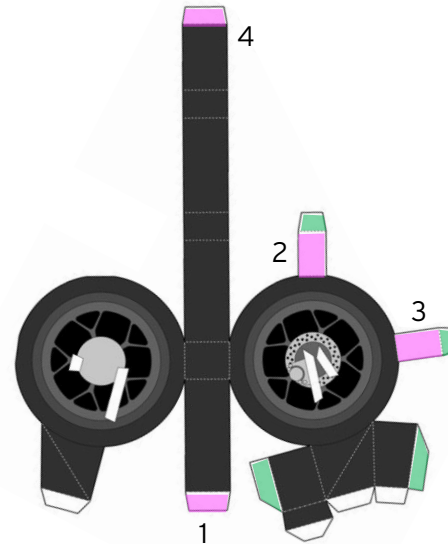

③ Join pink, and then join green.



☆ Hint: ☆

Join pink in this order!

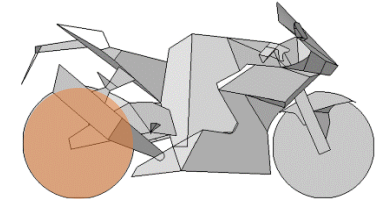

## Step 14: Under cowl

① Fold along lines.



② Apply glue.

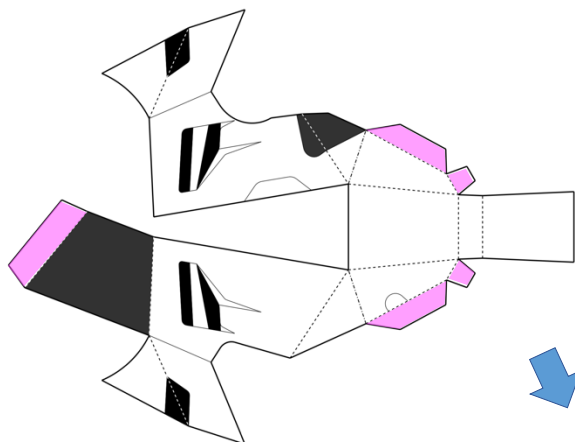

③ Join together.

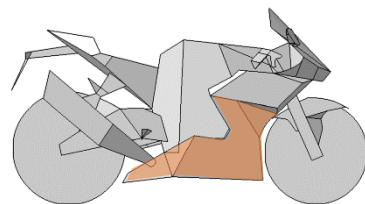

## Step 15: Front cowl

① Fold along lines.



② Apply glue in this order.

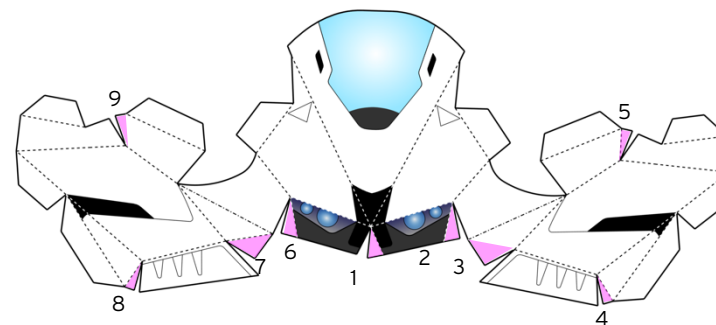

③ Join together.

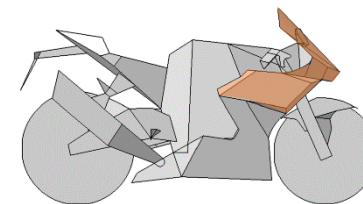
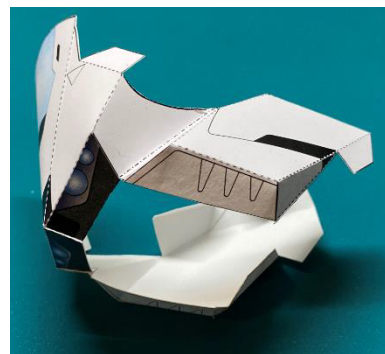

## Steps 16-17: Right / left pillion steps

\* Left pillion step not required for racing model

① Fold along lines.



② Apply glue.

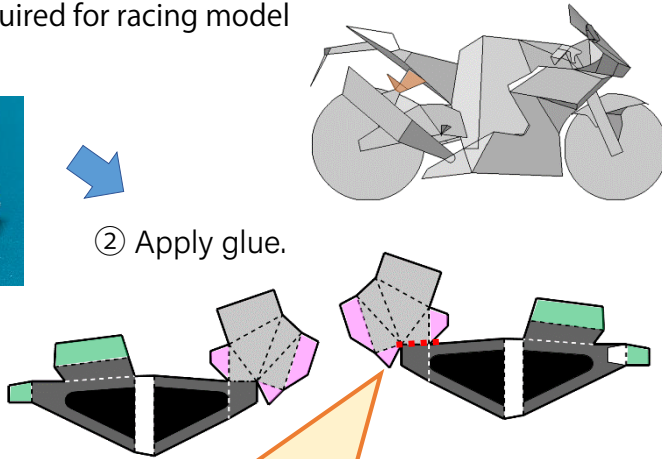

③ Join pink.



For the racing model,  
cut along the red line of the right pillion step.

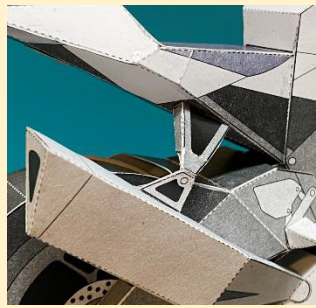

④ Join green.



## Step 18: Muffler bracket

① Fold along lines.



② Apply glue on the back  
(unprinted) side.

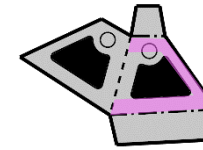

③ Join together.

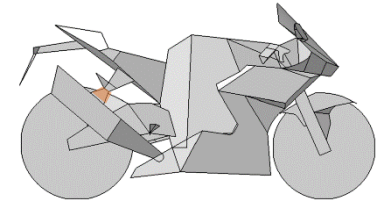

## Steps 19-20: Right / left mirrors

\*Not required for racing model

① Fold along lines.

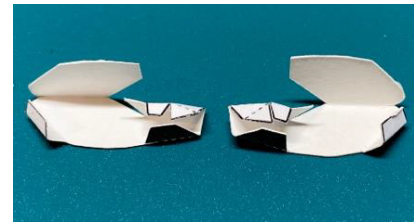

② Apply glue.

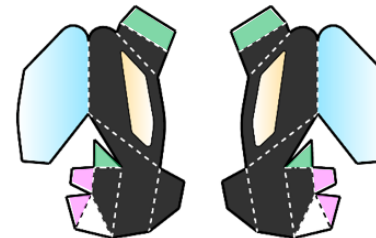

③ Join pink.

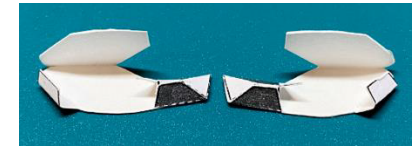

④ Join green.

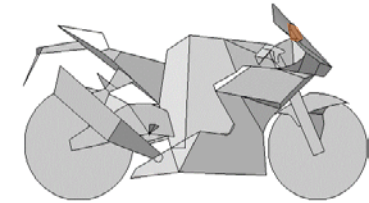

## Step 21: Rear fender

\*Not required for racing model

① Fold along lines.

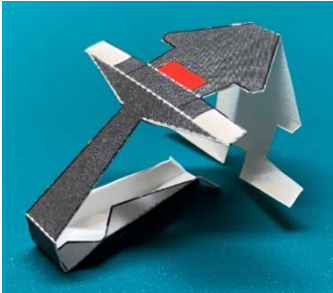

② Apply glue.

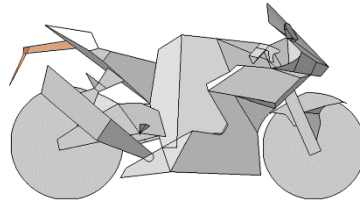
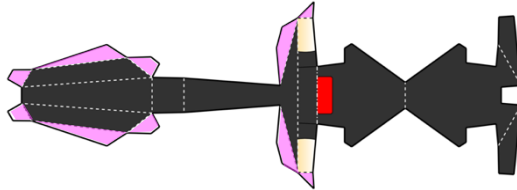

③ Fold over together.

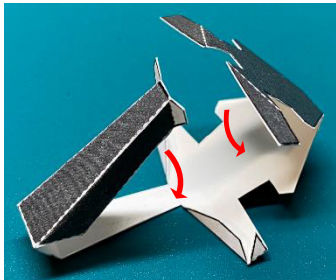

④ Join both sections together.



## Step 22: License plate

\*Not required for racing model

① Apply glue on the back (unprinted) side.



Draw your own license plate!

② Join together, then glue license plate to rear fender.

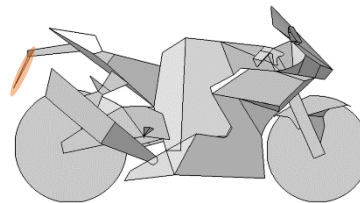
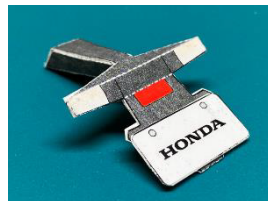

You've built all the parts!  
Now the real fun starts by  
assembling the whole bike!

## Step ①: Front forks + front fender

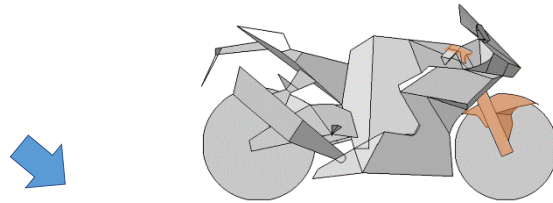
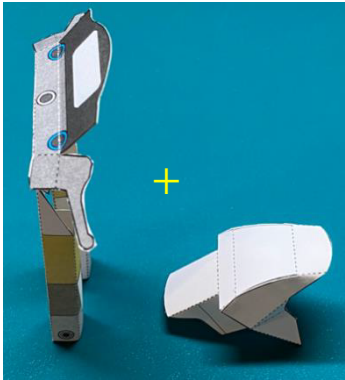

① Apply glue to pink areas, and join A and B together.

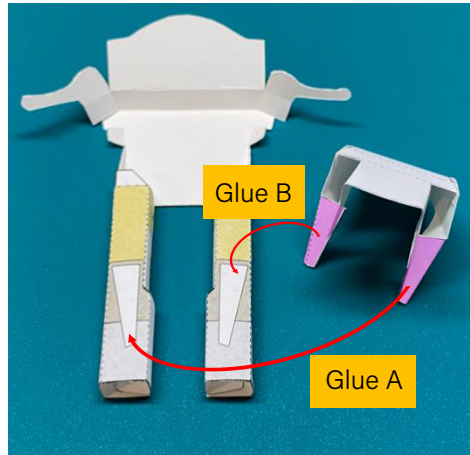

② Apply glue to pink area, and join C and D together.

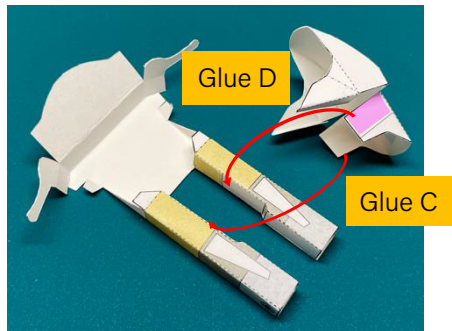

③ Done!



## Step ②: ① + front tire

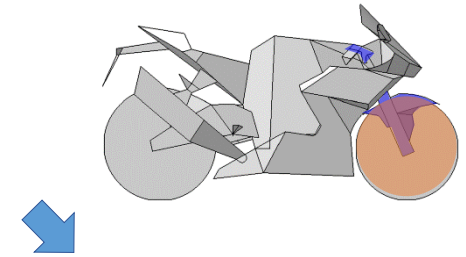
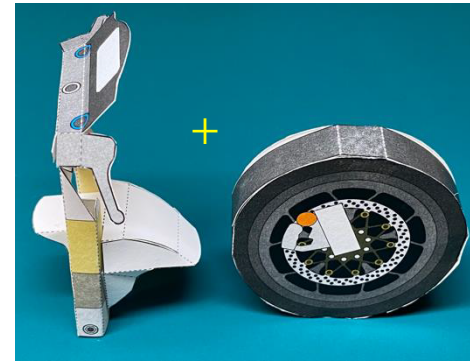

① Apply glue to pink areas, and join E and F together.

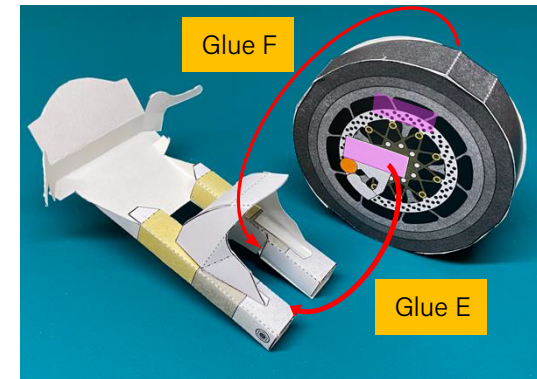

② Done!



☆ Hint: ☆

Don't put the tire on the wrong way!

### Step ③: ② + right / left handlebars

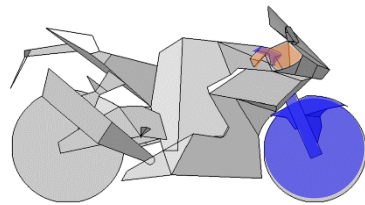
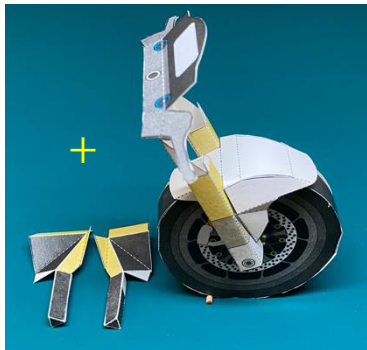

\* Insert into handlebar

① Apply glue to pink areas.

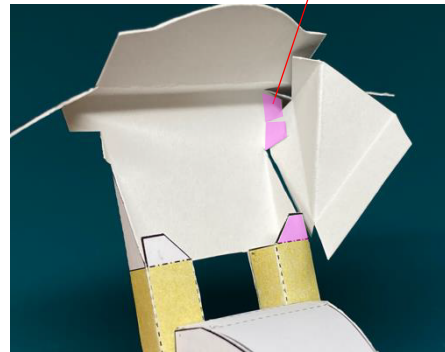
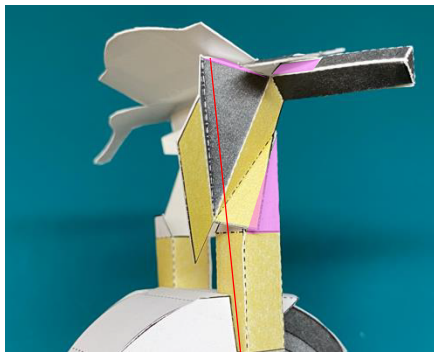

\* Join handlebar to the back of the instrument panel



② Join the other handlebar to the instrument panel.



### Step ④: ③ + chassis

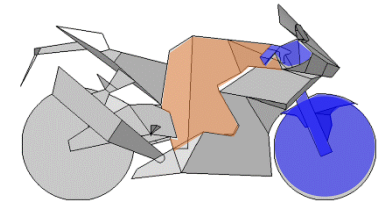

① Apply glue to pink areas, and join chassis to G.



② Done!



## Step ⑤: ④ + seat

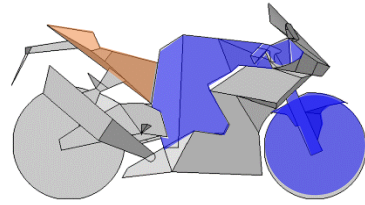
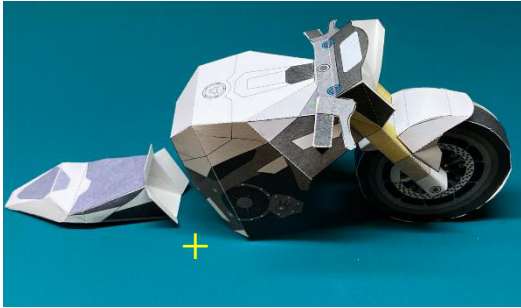

① Apply glue to the three pink areas.

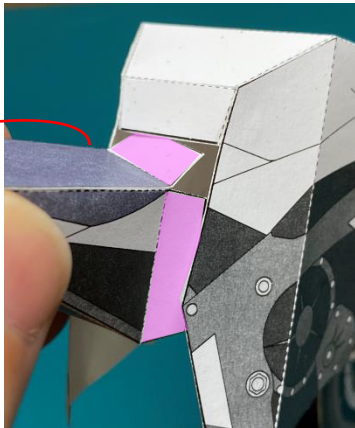

\* Don't forget this side as well!

② Join the seat to ④.

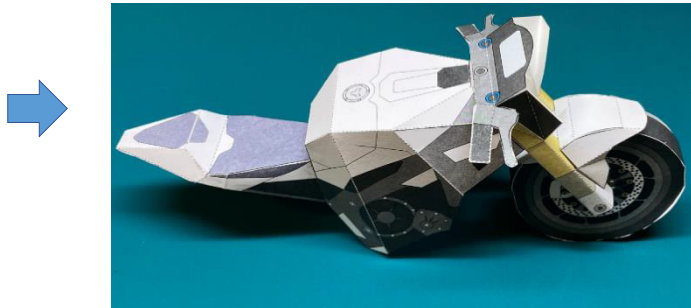

## Step ⑥: ⑤ + rear tire

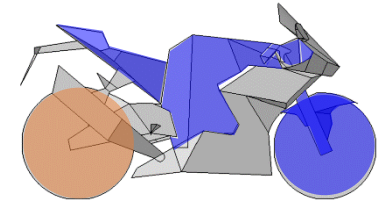
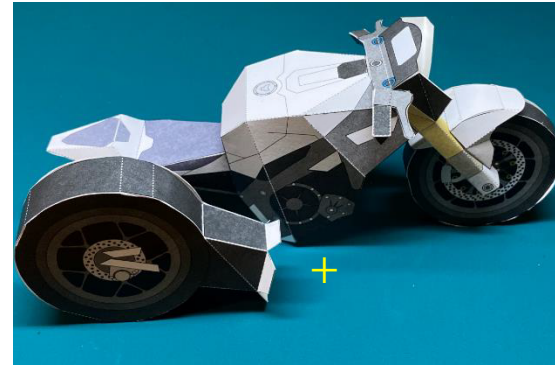

② Apply glue to the two pink areas.

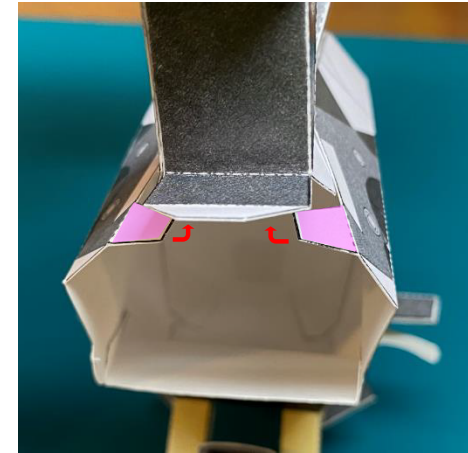

① Apply glue to the three pink areas.

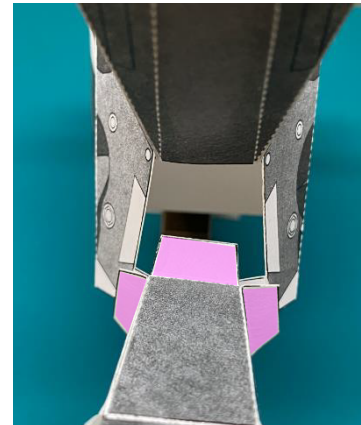

③ Join the rear tire to ⑤.

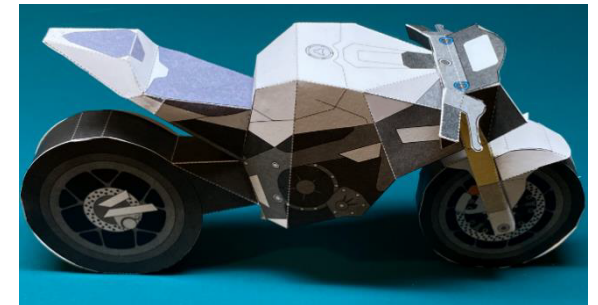



## Step ⑦: ⑥ + right / left swingarms

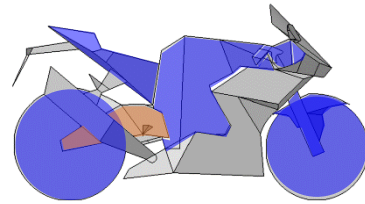
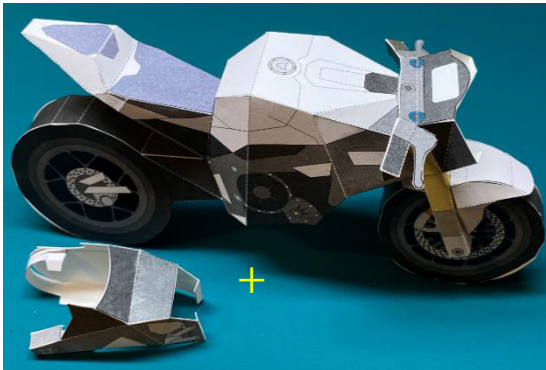

① [Right swingarm] Apply glue to the three pink areas, and join to ⑥.

② [Left swingarm] Apply glue to the three pink areas, and join to ⑥.

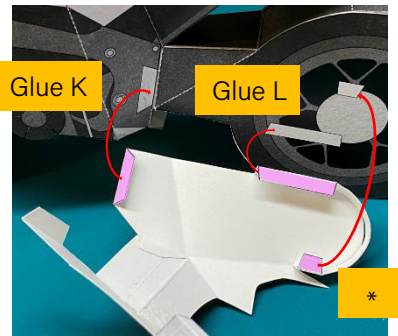
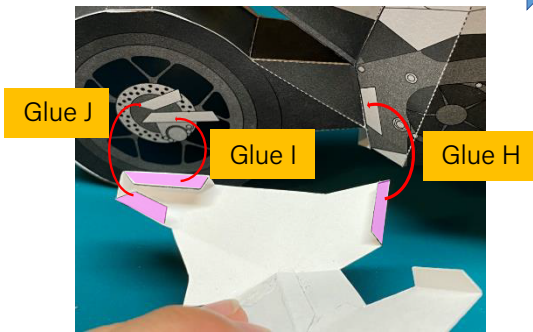

③ Done!



## Step ⑧: ⑦ + front cowl

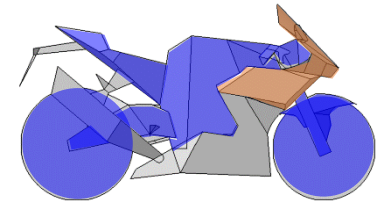
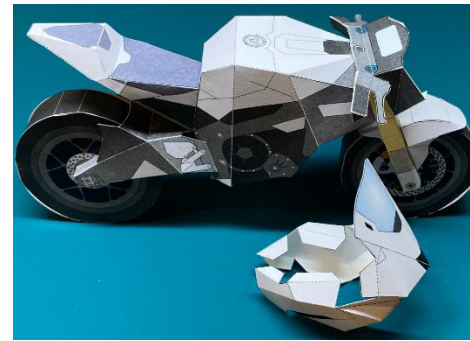

① Apply glue to pink areas and join to ⑦ (both sides).

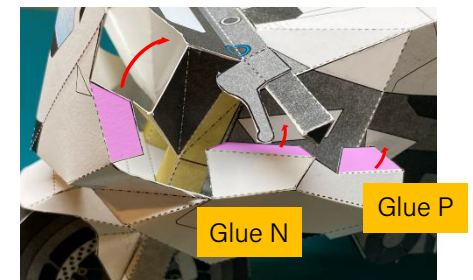
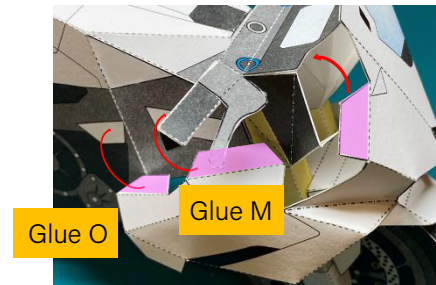

② Done!

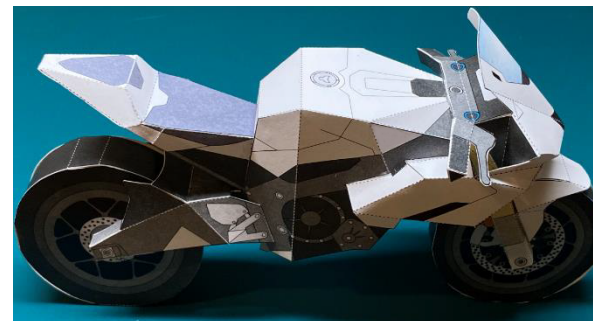

## Step ⑨: ⑧ + undercowl

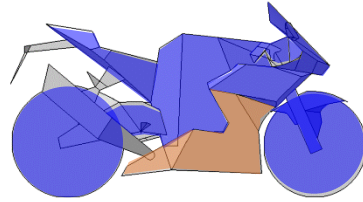
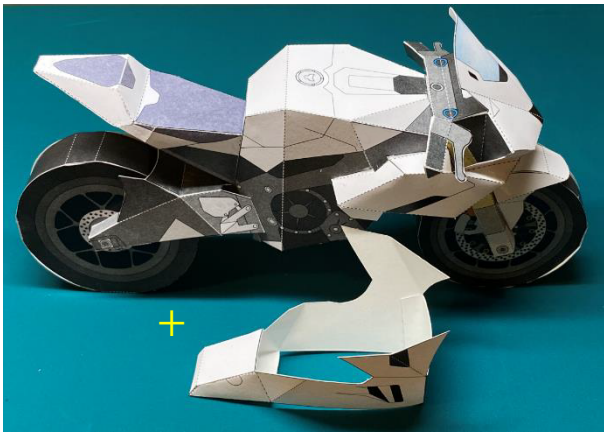

① Apply glue to pink areas, and join undercowl to ⑧.



② Repeat for the other side!

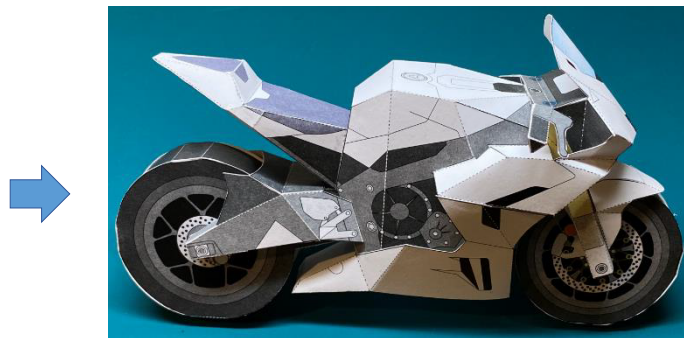

## Step ⑩: ⑨ + right / left steps

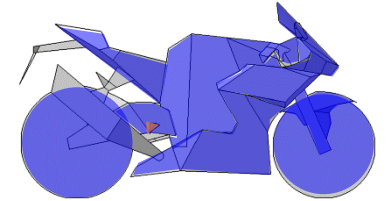
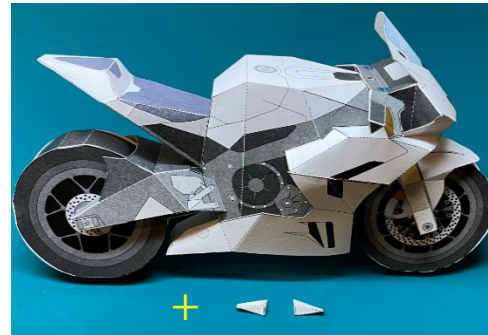

① Apply glue to pink areas, and join step to ⑨.

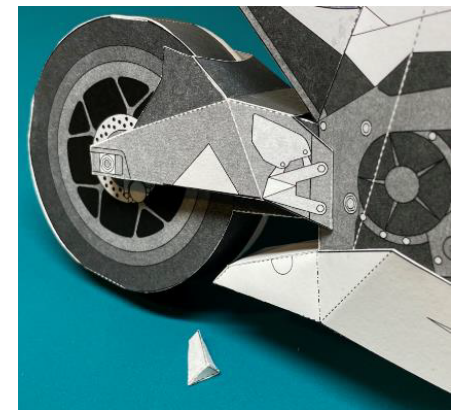

② Repeat for the other side!

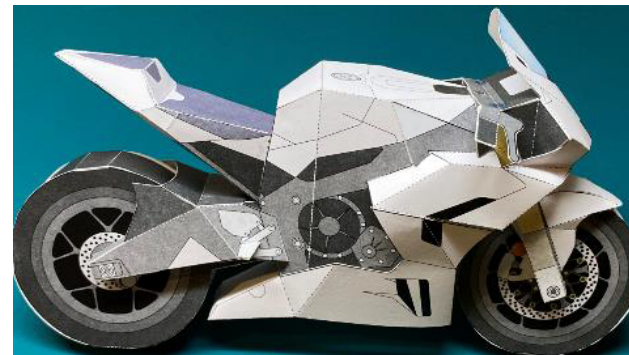

## Step 11: 10 + muffler

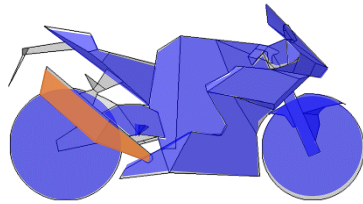
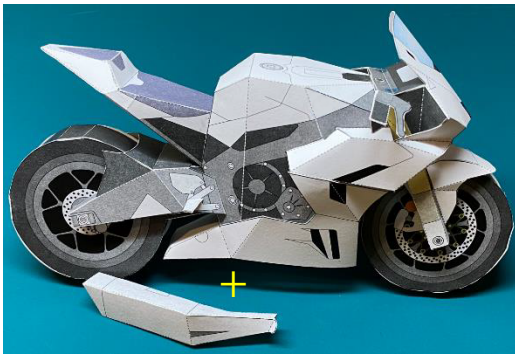

① Apply glue to pink areas.

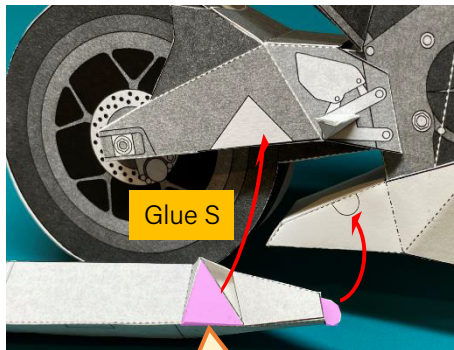

② Join muffler to 10.

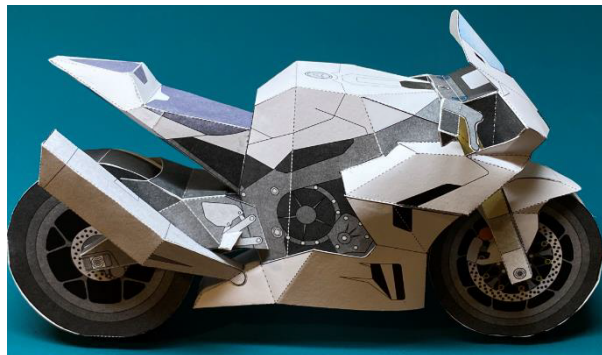

☆ Hint: ☆

Use lots of glue here!

## Step 12: 11 + right / left pillion steps + muffler bracket

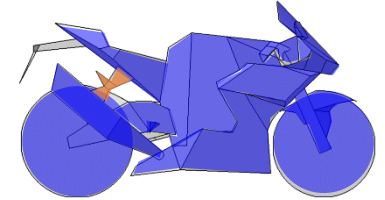
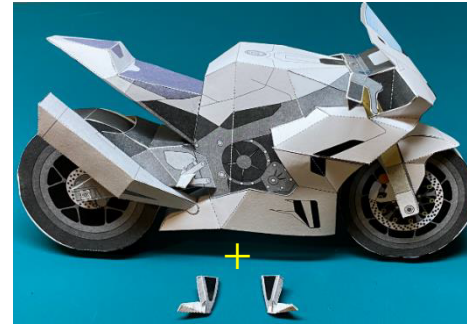

① [Right pillion step + muffler bracket]  
Apply glue to pink areas, and join together.

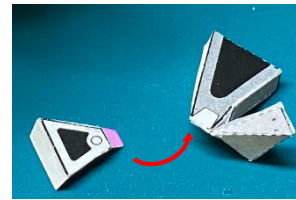

② Apply glue to pink areas,  
and join together.



③ Repeat for the other left side  
(\* not required for racing model)



### Step 13: 12 + right / left mirrors

\*Not required for racing model

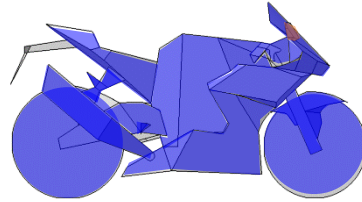
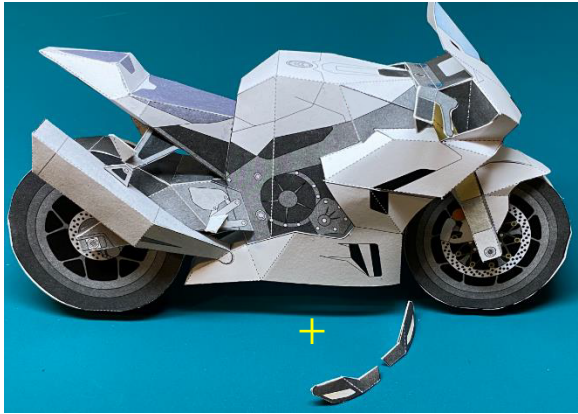

① Apply glue to pink areas, and join together.

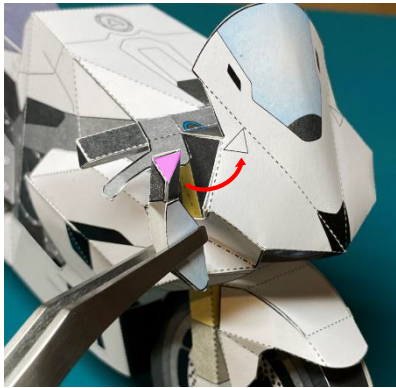

② Repeat for the other side!



### Step 14: 13 + rear fender

\*Not required for racing model

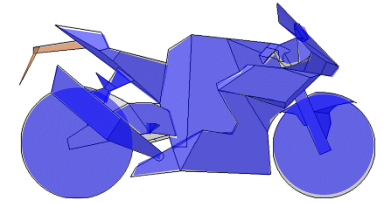
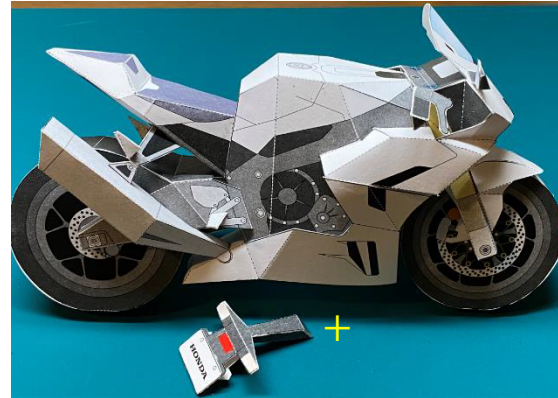

① Apply glue to pink areas, and join together.

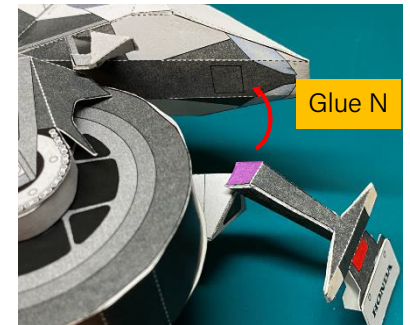

② Done!



Road model complete!!